

FT-890

Technical Supplement



VERTEX STANDARD CO., LTD.
4-8-8 Nakameguro, Meguro-Ku, Tokyo 153-8644, Japan
VERTEX STANDARD
US Headquarters
10900 Walker Street, Cypress, CA 90630, U.S.A.
International Division
8350 N.W. 52nd Terrace, Suite 201, Miami, FL 33166, U.S.A.
YAESU EUROPE B.V.
P.O. Box 75525, 1118 ZN Schiphol, The Netherlands
YAESU UK LTD.
Unit 12, Sun Valley Business Park, Winnall Close
Winchester, Hampshire, SO23 0LB, U.K.
VERTEX STANDARD HK LTD.
Unit 5, 20/F., Seaview Centre, 139-141 Hoi Bun Road,
Kwun Tong, Kowloon, Hong Kong

Contents

Introduction & Chip Component Replacement	1
Circuit Board Access, Battery & Lamp Replacement, CPU Resetting	2
Alignment	3
Block & Interconnection Diagrams	4
PCB Diagrams & Parts Lists	5
Local Unit	5A
RF Unit	5B
Display Unit	5C
100-W Power Amp (PA) Unit	5D
LPF Unit	5E
Keyer Unit	5F
Tuner Main Unit	5G
Tuner Control Unit	5H
Carrier (CAR) DDS Unit	5I
PLL Sub-Loop (SUB) DDS Unit	5J
Notch Unit	5K
Potentiometer (VR) A, B & Clarifier (CLAR) Units	5L
Headphone (HP), Microphone (MIC) & Potentiometer (VR) C Units	5M
Potentiometer (VR) D & Keyer Control Units	5N
Switch A Unit	5O
Switch B Unit	5P
Switch C Unit	5Q
Mechanical Details (Exploded View & Mechanical Parts)	6

Introduction



This manual provides technical information necessary for servicing the Yaesu FT-890 HF Transceiver. It does not include information on specifications, installation and operation, which are described in the *FT-890 Operating Manual*, provided with each transceiver, or on FT-890 accessories, which are described in manuals provided with each.

Servicing this equipment requires expertise in handling surface mount chip components. Attempts by non-qualified persons to service this equipment may result in permanent damage not covered by warranty.

For the major circuit boards, each side of the board is identified by the type of the majority of components installed on that side. In most cases one side has only chip components, and the

other has either a mixture of both chip and lead components (trimmers, coils, electrolytic capacitors, packaged ICs, etc.), or lead components only.

While we believe the technical information in this manual is correct, Yaesu assumes no liability for damage that may occur as a result of typographical or other errors that may be present. Your cooperation in pointing out any inconsistencies in the technical information would be appreciated.

Yaesu Musen reserves the right to make changes in this transceiver and the alignment procedures, in the interest of technological improvement, without notification of the owners.

Circuit Board Access

- ❑ Turn the transceiver off and disconnect all cables.
- ❑ Place the set upside-down on the work surface, with the rear facing you, and remove the 8 screws affixing the bottom cover (photos 1 & 2). This exposes the component side of the RF Unit.
- ❑ To remove the top cover, disconnect the light-blue-banded coaxial cable from J2026 on the rear of the exposed RF Unit (photo 3).
- ❑ Note: the cable must be reconnected to J2026 during alignment (except for Local Unit and PA Unit procedures).
- ❑ Place the transceiver topside-up so the rear panel is facing you, and remove the 4 screws indicated in photo 4.
- ❑ Remove the 4 screws in the shield panel at the left, as shown in photo 5, to access the Local Unit.
- ❑ Remove the 11 screws in the shield panel at the right to access the PA, LPF and Keyer Units.

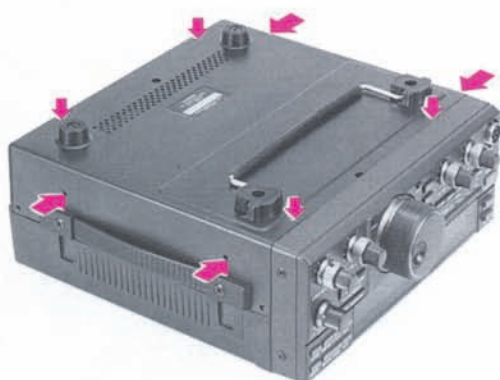

Photo 1

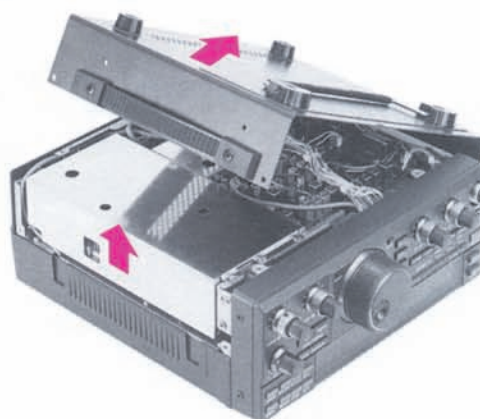

Photo 2

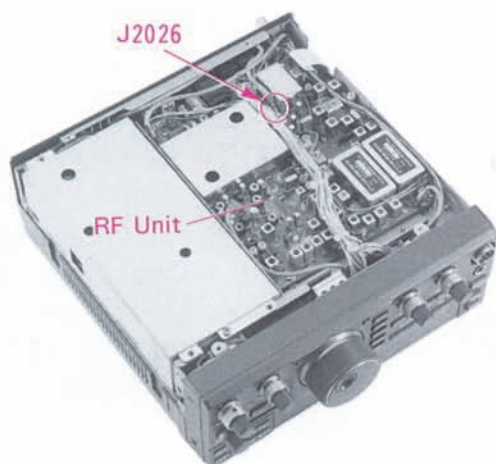

Photo 3



Photo 4

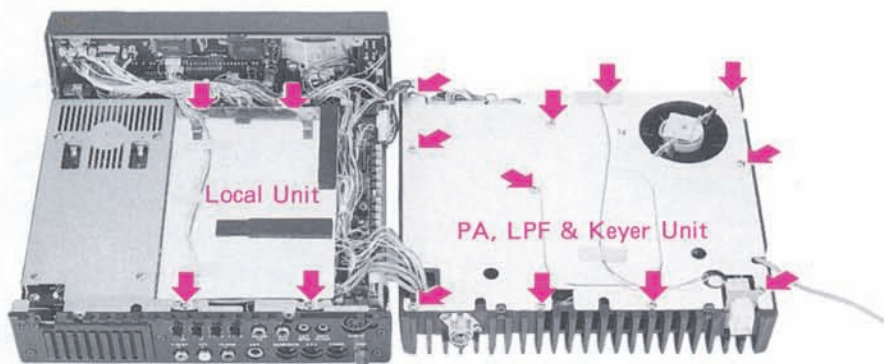
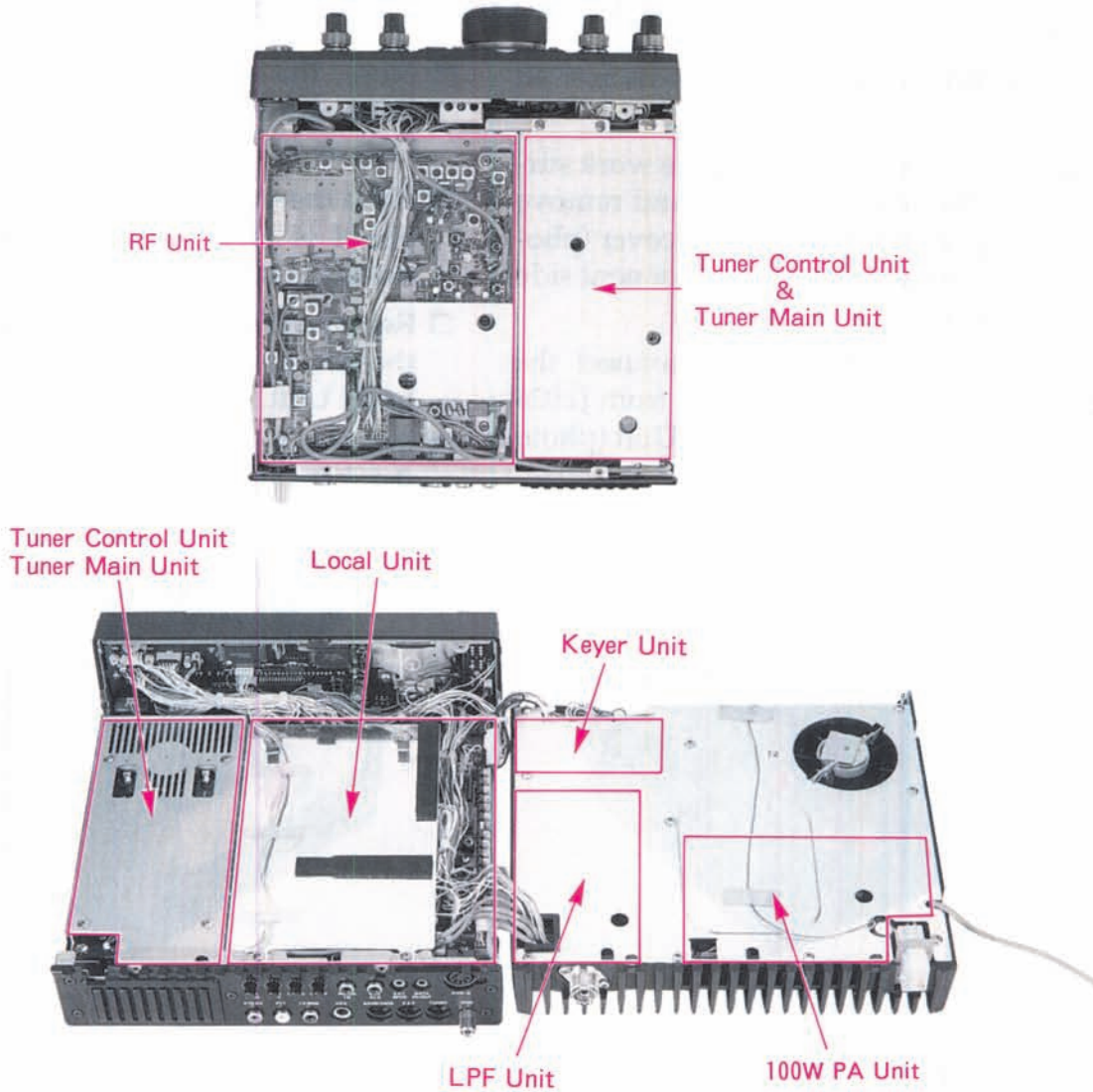
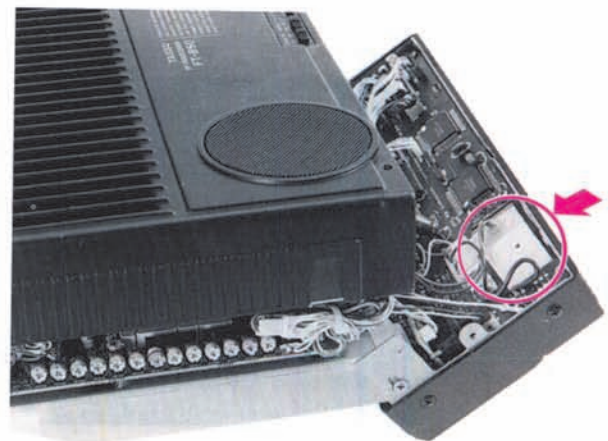

Photo 5



Battery & Pilot Lamp Replacement

- ❑ Disconnect all cables and remove the top and bottom covers.
- ❑ Remove the 4 screws from both sides of the front panel, as indicated below (for pilot lamp replacement, the bottom two screws can be just loosened).
- ❑ Gently pull the front panel away from the chassis (or just fold it down for pilot lamp replacement).
- ❑ Pilot lamp location is indicated below. To change the backup cell, use your fingers to remove the old cell from its holder (do not grab it with metal tweezers or pliers, as that could short it out). Replace only with Sony lithium type CR2032 (Yaesu part number Q900564), or equivalent.



Resetting the Microprocessors

Functional problems involving frequency, mode and memory selection can sometimes be resolved simply by resetting the microprocessors. There are two ways to reset the microprocessors in the FT-890, both of which clear the contents of all memories, leaving them at the factory defaults.

Soft Reset

This procedure relies on a ROM routine which should normally suffice to correct most operating misfunctions. Turn the transceiver

off, then hold both the **HAM/GEN** button and the **CLAR** button while switching the transceiver back on. If the problem persists, proceed to the Hard Reset.

Hard Reset

- Turn the transceiver off, and then turn the Backup switch (inside the hole near the front center of the bottom cover) off.
- Let the transceiver sit for several minutes.
- Turn the transceiver on, then turn the Backup switch back on (after the transceiver has been turned on).

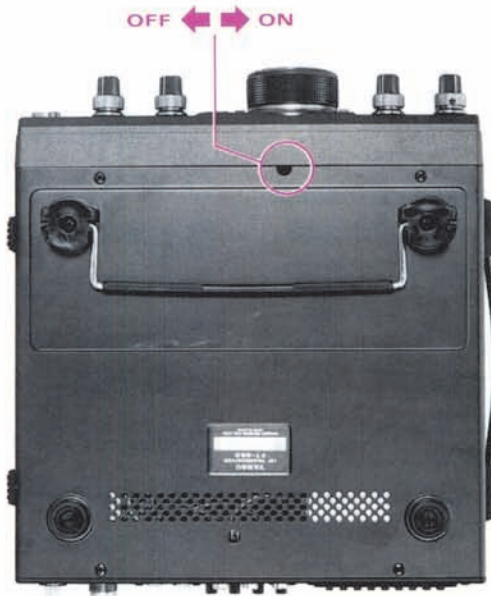

Alignment

The FT-890 is carefully designed to allow the knowledgeable operator to make nearly all adjustments required for various station conditions, modes and operator preferences simply from the controls on the panels, without opening the case of the transceiver. The *FT-890 Operating Manual* describes these adjustments, plus certain internal settings.

The following procedures cover the sometimes critical and tedious adjustments that are not normally required once the transceiver has left the factory. However, if damage occurs and some parts subsequently be replaced, realignment may be required. If a sudden problem occurs during normal operation, it is likely due to component failure; realignment should not be done until after the faulty component has been replaced.

We recommend that servicing be performed only by authorized Yaesu service technicians, experienced with the circuitry and fully equipped for repair and alignment. So if a fault is suspected, you should contact the selling dealer for instructions regarding repair. Authorized Yaesu service technicians have the latest modification information, and realign all circuits and make complete performance checks to ensure compliance with factory specifications after replacing faulty components.

Those who do undertake any of the following alignments are cautioned to proceed at their own risk. Problems caused by unauthorized attempts at realignment are not covered by the warranty policy. Also, Yaesu must reserve the right to change circuits and alignment procedures in the interest of improved performance, without notifying owners.

Under no circumstances should any alignment be attempted unless the normal function and operation of the transceiver are clearly understood, the cause of the malfunction has been clearly pinpointed and any faulty components replaced, and the need for realignment determined to be absolutely necessary.

The following test equipment (and thorough familiarity with its correct use) is necessary for complete realignment. Correction of problems caused by misalignment resulting

from use of improper test equipment is not covered under the warranty policy. While most steps do not require all of the equipment listed, the interactions of some adjustments may require that more complex adjustments be performed afterwards. Do not attempt to perform only a single step unless it is clearly isolated electrically from all other steps. Rather, have all test equipment ready before beginning, and follow all of the steps in a section in the order they are presented.

- Digital DC Voltmeter (high-Z, >1 M Ω /V)
- DC Ammeter
- RF Millivoltmeter
- AF Millivoltmeter
- RF Standard Signal Generator w/calibrated output and dB scale, 0 dB μ = 0.5 μ V
- AF Signal Generator with calibrated output
- Spectrum Analyzer or receiver (30 MHz)
- Oscilloscope
- Frequency Counter
- 50- Ω Dummy Load (150 ~ 250 watts)
- 16.6- Ω Dummy Load (>150 W)
- In-Line Wattmeter (150 ~ 250 W, 50- Ω)
- Linear Detector
- RF Attenuator (>150-W, 40-dB) or coupler

Alignment Preparation & Precautions

A 50- Ω dummy load and inline wattmeter must be connected to the antenna jack in all procedures that call for transmission, except where specified otherwise. Correct alignment is not possible with an antenna.

Except where specified otherwise, the transceiver should be tuned to 14.2 MHz, USB mode, and these controls set as indicated:

- MOX & VOX** buttons OFF (■)
- AGC-F** button ON (—)
- PROC, IPO, ATT & RPT/T** buttons OFF (■)
- MIC & RF PWR** fully ccw (minimum)
- AF** as required, **RF** fully cw (maximum)
- NB** 12-o'clock, **SQL** fully ccw
- NOTCH & SHIFT** to 12-o'clock

After completing one step, read the following step to determine whether the same test equipment will be required. If not, remove the test equipment (except dummy load and wattmeter, if connected) before proceeding.

Correct alignment requires that the ambient temperature be the same as that of the transceiver and test equipment, and that this temperature be held constant between 20 and 30 °C (68 ~ 86 °F). If the transceiver is brought into the shop from hot or cold air it should be allowed some time for thermal equalization with the environment before alignment.

Alignments must only be made with oscillator shields and circuit boards firmly affixed in place. Only one extender board should be installed at a time for access to the board being aligned. Also, the test equipment must be thoroughly warmed up before beginning.

Note: Signal levels in dB referred to in alignment are based on $0 \text{ dB}\mu = 0.5 \text{ }\mu\text{V}$.

Table note: DC voltages should be within $\pm 10\%$ of those listed in the voltage tables.

Local Unit

Refer to the Local Unit Alignment Diagram on page 3-10. To prevent PLL unlock from interfering with the Local Unit alignment process, connect TP1008 to ground. Remember to disconnect TP1008 when finished alignment.

Reference Oscillator

- Connect the frequency counter to TP1004.
- If the counter frequency differs by more than 5 Hz from 10.485760 MHz, adjust the TCXO-3 trimmer (if the TCXO is installed) or TC1002.
- Replace the counter with the RF millivoltmeter, and confirm at least 120 mV_{rms}.

70-MHz 2nd Local Oscillator

- Remove the coaxial plug from J1003 and connect a 50- Ω resistor in parallel with the frequency counter across the socket.
- Adjust L1002 for 70.00000 MHz \pm 20 Hz.
- Replace the counter with the RF millivoltmeter, and confirm at least 40 mV_{rms}.

- Remove the meter and resistor, and replace the plug in J1003.

Carrier DDS Check

- Turn the **MIC** and **RF PWR** controls fully ccw (minimum), and connect the frequency counter to TP1009.
- Select LSB mode, key the transmitter, and confirm 453.500 kHz on the counter.
- Select USB mode, key the transmitter, and confirm 456.500 kHz on the counter.
- Select CW mode, key the transmitter, and confirm 455.800 kHz on the counter.
- Select AM mode, key the transmitter, and confirm 455.000 kHz on the counter.
- Connect the RF millivoltmeter to TP1009 and at least 80 mV_{rms} in USB mode.

Sub-Loop: DDS Check

Tune the transceiver display to 7.0451 MHz. Connect the RF millivoltmeter to TP1010 and confirm at least 40 mV_{rms}.

Sub-Loop: DDS Check

- Tune the transceiver display to 7.04511 MHz. Connect the frequency counter to TP1007 and adjust L1045, if necessary, for 60 to 60.1 MHz on the counter.
- Connect the RF millivoltmeter to TP1011 and adjust T1002 and T1003 alternately several times for maximum RF voltage.
- Connect the DC voltmeter to TP1001 and adjust L1045 for $5.0 \pm 0.2 \text{ V}$.
- Tune the transceiver up 10 Hz to 7.04512 MHz and confirm $3.0 \pm 0.2 \text{ V}$ at TP1001.
- Tune the transceiver to 7.1270 MHz, connect the RF millivoltmeter to TP1012, and adjust T1002 and T1003 alternately (again) several times for maximum RF voltage (at least 10 mV_{rms}).

Main PLL: Local BPF & VCV

- Tune the transceiver to 7.1400 MHz, and connect the RF millivoltmeter to TP1002 (pin 13 of Q1042).
- Adjust T1005 and T1006 alternately several times for peak RF voltage (at least 100 mV_{rms}). Leave the meter at TP1002.

- Connect the DC voltmeter to TP1003. Tune the display to each adjustment frequency in the following table and adjust the corresponding trimmer capacitor for 6.0 ± 0.2 V on the DC voltmeter. Then retune to the check frequency and confirm the corresponding check voltage (± 0.5 V). Repeat at each listed frequency.

Adjustment Freq. (VCO#)	Adj. for 6 V @TP1003	Check	
		Freq.	Volts
30.00000 (VCO4)	TC1005	21.50000	1.8
21.49999 (VCO3)	TC1004	14.50000	1.8
14.49999 (VCO2)	TC1003	7.50000	1.6
7.49999 (VCO1)	TC1001	0.10000	1.7

- Tune the transceiver to 29.9800 MHz and again adjust T1005 and T1006 alternately several times for peak RF voltage (at least 100 mV_{rms}) at TP1002.

1st Local Output Level Check

- Remove the plug from J1001 and connect a 50-Ω resistor and RF voltmeter in its place.
- Tune to 30.00000 MHz and confirm at least 400 mV_{rms} on the meter. Replace the plug in J1001.

PA Unit (RF Power Amplifier)

Final Idling Current

Make sure the transceiver has been on for at least several minutes. Connect the DC voltmeter between TP4001 (+) and TP4002 (—) on the PA Unit. Key the transmitter in an SSB mode, and with no microphone input, adjust VR4001 for $6.0 \text{ mV} \pm 0.5 \text{ mV}$.

LPF Unit

CM Coupler Balance

With the 50-Ω dummy load connected to the antenna jack, tune the transceiver to 14.2 MHz, and select the CW mode. Connect the DC voltmeter between pins 3 (—) and 4 (+) of J5006, key the transmitter and adjust TC5001 for *minimum* on the voltmeter.

Tuner Unit

Tuning Capacitor/Motor (Mechanical Check, Setting & Adjustment)

- Loosen all set screws in the shaft coupler, and turn the coupler by hand to confirm it moves freely (the motor and capacitor should not move). If the coupler binds, check the motor mounting position (it is

VR4001
Final Idling Current

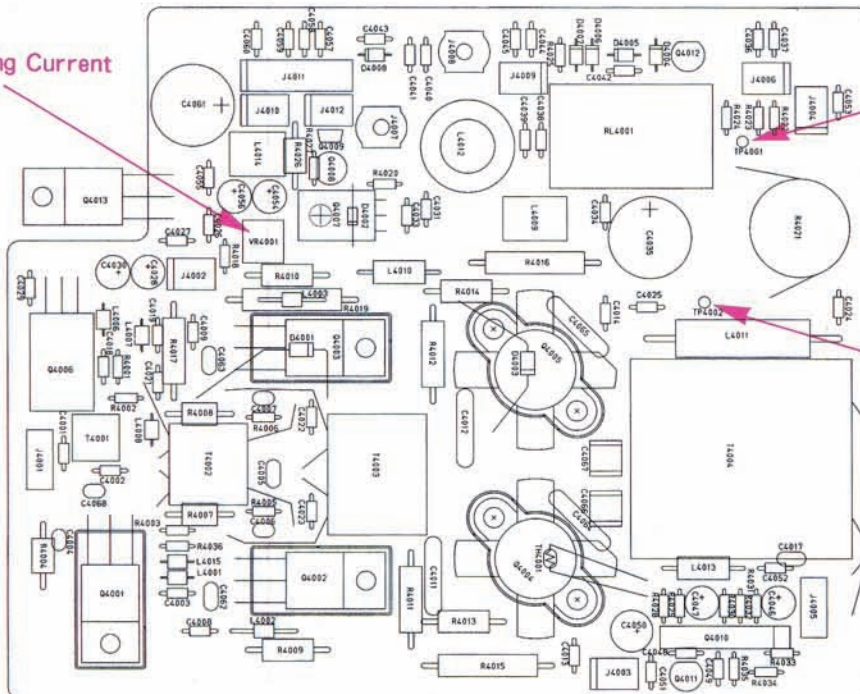

TP4001
Connect + lead of
DC Voltmeter

TP4002
Connect - lead of
DC Voltmeter

100-W Power Amp (PA) Unit Test & Alignment Points

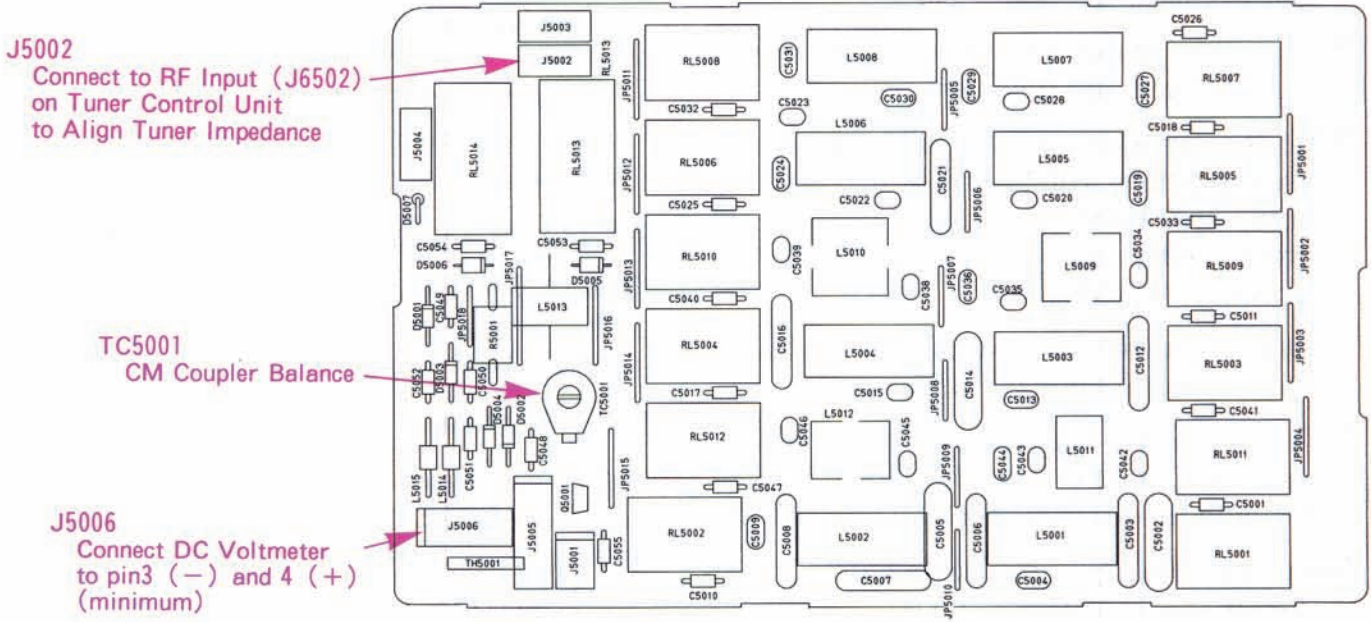

LPF Unit Test & Alignment Points

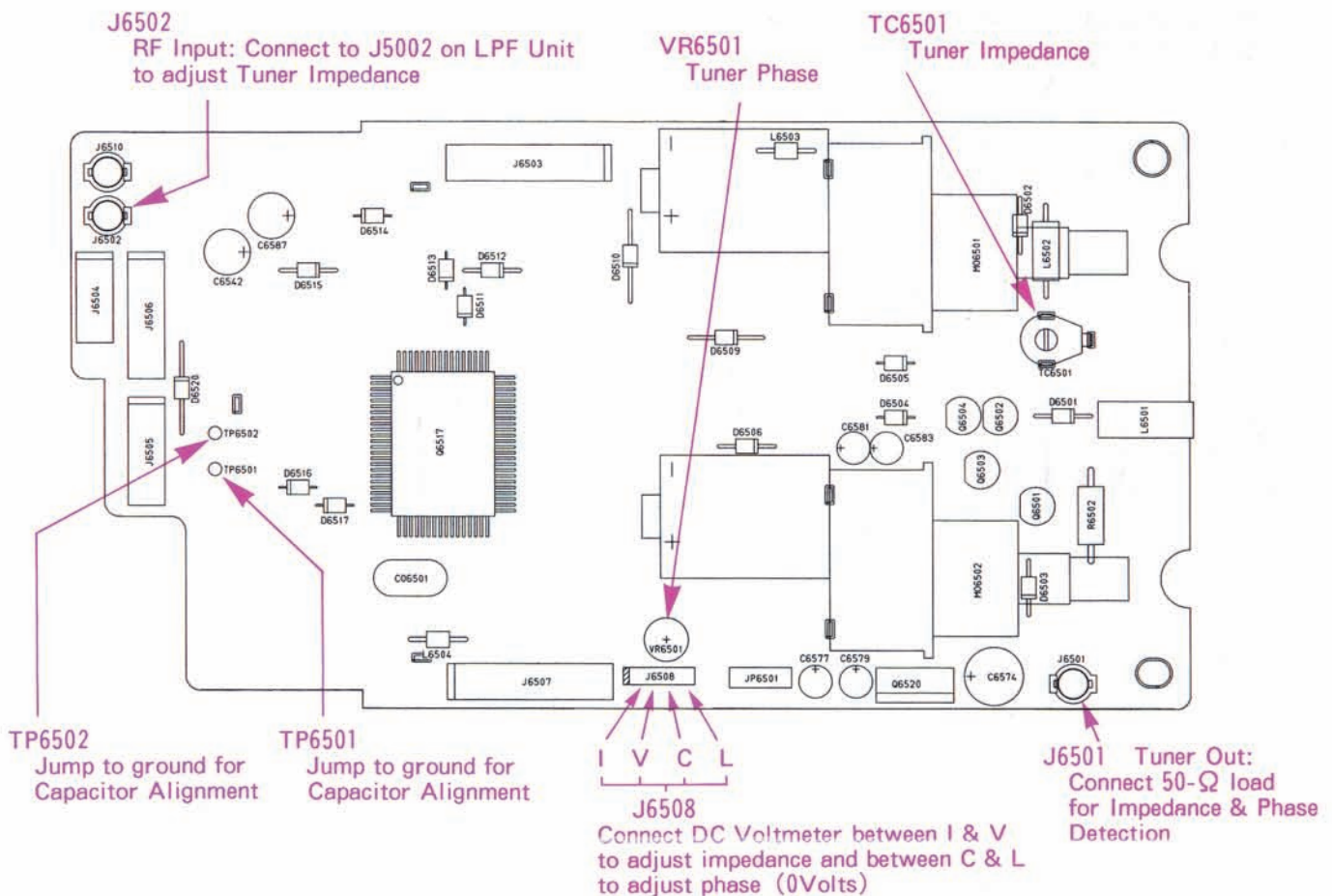

Tuner Control Unit Test & Alignment Points

- soldered in place) and the capacitor mounting (screws).
- Turn the power switch off, and jump TP-6501 to chassis ground.
- Turn the power switch on. The motor should rotate, and then stop.
- Set the capacitor to its maximum capacitance position (plates fully meshed) by hand, and tighten all shaft coupler set screws, using care not to disturb the capacitor or motor positions.
- Turn the power off, and jumper TP6502 to chassis ground (along with TP6501).
- Turn the power back on. The motor should move 180°, and the capacitor should be then at minimum capacitance (fully unmeshed).
- Remove the grounding jumpers from TP6501 and TP6502.

Tuner Impedance & Phase Detection

- Connect the 50-Ω dummy load and wattmeter to J6501 (the output of the Tuner Control Unit), and connect J6502 (RF IN) to J5002 (LPF OUT). Tune the transceiver to 14.000 MHz, CW mode.
- Connect the DC voltmeter between pins 1 ("I") and 2 ("V") of J6508 (either polarity).

- Press the **TUNER** and **MOX** buttons, adjust the **RF PWR** control for 50 watts output, and then adjust TC6501, if necessary, for meter indication within ± 0.08 V of 0 V.
- While still transmitting, move the DC voltmeter to pins 3 ("C") and 4 ("L") of J6508 (either polarity), and adjust VR6501, if necessary, for meter indication within ± 0.02 V of 0 V.

RF Unit Local Signals and Oscillators

- With the RF millivoltmeter, confirm at least 900 mV_{rms} at TP2001, and 400 mV_{rms} at TP2002 (see page 3-11).

Notch Oscillator

- Connect the frequency counter to TP2004 (pin 7 of Q2020), and with the **NOTCH** control at 12 o'clock, adjust L2062 for 8.67 MHz ± 50 Hz.
- Replace the counter with the RF voltmeter, and adjust T2032 for maximum voltage (at least 300 mV_{rms}).

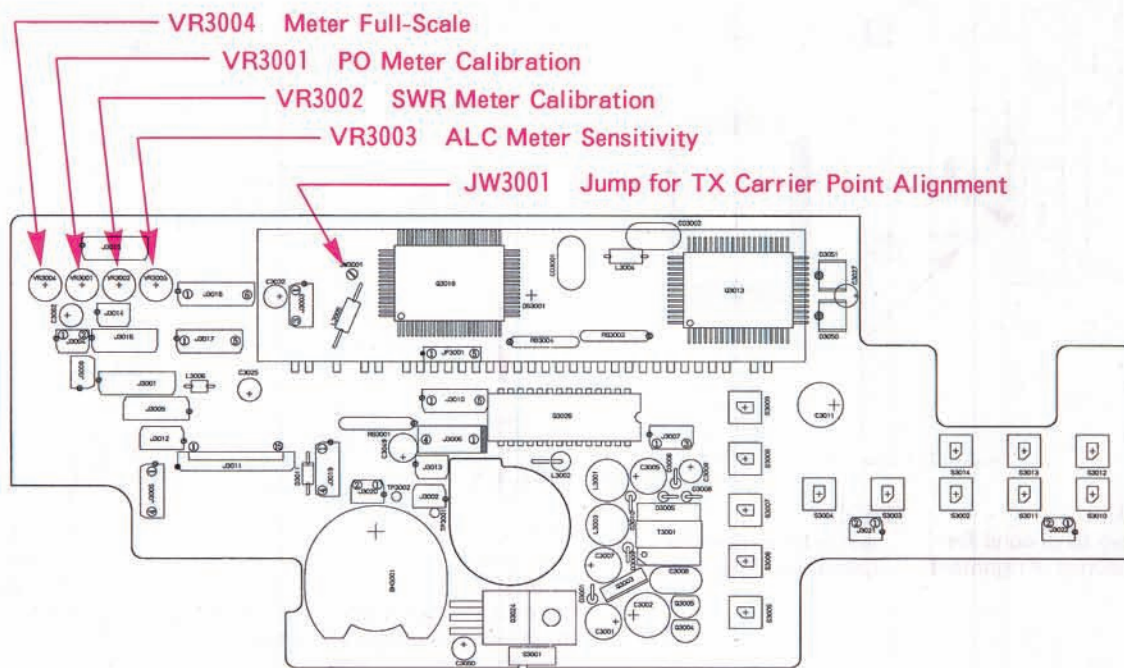

Display Unit Test & Alignment Points

Receiver Circuits

IF Interstage Transformers (I)

(coarse alignment - only for new IF Unit)

- Connect the RF signal generator to J2024 on the RF Unit, and inject 100 dB μ at 14.200 MHz. Connect the AF millivoltmeter across and 8- Ω load to the **EXT SP** jack on the rear panel.
- Preset VR2003 fully clockwise, and adjust T2005, T2009 ~ T2012 and T2014 ~ T2021 in succession several times peak AF output.

SSB Detector Balance

Inject 40 dB μ at 14.200 MHz to the antenna jack and adjust VR1001 on the Local Unit for peak AF output.

1st Mixer Balance

In LSB mode, tune to the internal heterodyne at 164 kHz, and adjust VR2001 and VR2002 alternately several times for a null in AF output.

Meter Full Scale

- Turn the transceiver off, and hold the **ALC**, **PO** and **SWR** buttons together while switching back on (to activate the meter test mode). Then press the **PO** button: the display should show "50".
- Adjust VR3004 on the Display Unit so the meter deflects to the **S9+40 dB** marker on the S-meter scale.
- Press the **PO** button again to return to normal operation.

S-Meter Threshold

- After performing the above full-scale adjustment, preset VR2006 on the RF Unit to the 12 o'clock position.
- Turn the **SQL** control fully clockwise and adjust VR2005 to the point just before the S-meter begins to deflect. Then return the **SQL** control fully counterclockwise.

IF Interstage Transformers (II)

- Connect the RF signal generator to the antenna jack, and inject 80 dB μ at 14.200 MHz.

- Adjust T2005, T2009 ~ T2012 and T2014 ~ T2021 in succession several times for peak S-meter indication (adjust the injection level as necessary to keep the meter around mid scale).

IF Gain

- Inject 7 dB μ at 14.200 MHz to the antenna jack, and tune for peak on the S-meter.
- Adjust VR2003 on the RF Unit for S-1 deflection.

S-Meter Full-Scale

- Inject 100 dB μ at 14.200 MHz to the antenna jack, and tune for peak on the S-meter.
- Adjust VR2006 on the RF Unit for **S9+60 dB** on the S-meter.
- Reduce the injection level so the S-meter deflects to **S9**, and confirm the injection is between 32 and 42 dB μ .

Notch Null

- Inject 40 dB μ at 14.200 MHz from the RF signal generator to the antenna jack. Select USB mode, make sure the **NOTCH** is off, and tune to 14.20150 MHz (so a 1500-Hz heterodyne is heard).
- Press the **NOTCH** button and, with the **NOTCH** control centered, adjust VR7201 on the Notch Unit and L2062 on the RF Unit alternately several times for minimum S-meter deflection or AF output.

SSB Squelch Threshold

In the USB mode, with no signal at the antenna jack, set the **SQL** control to the 10-o'clock position, and adjust VR1002 on the Local Unit so that the squelch just closes.

FM Squelch Threshold (must be done only after SSB Squelch Threshold, above)

In the FM mode, with no signal at the antenna jack, set the **SQL** control between the 9- and 10-o'clock positions, and adjust VR2004 on the RF Unit so that the squelch just closes.

Transmitter

Connect the 50- Ω dummy load to the antenna jack for all procedures.

ALC Meter Zero Set

Note: *Meter Full Scale* alignment on the previous page must be done before this procedure, and *Overcurrent ALC Zero Set* (below) and *Overcurrent ALC Turndown* (also below) must be done after.

- Select the ALC meter function, and preset VR1014 on the Local Unit fully counterclockwise.
- Select USB mode, key the transmitter, and with no modulation, adjust VR1017 on the Local Unit to the point where the ALC meter just begins to deflect.

Overcurrent ALC Zero Set

Note: *Overcurrent ALC Turndown* (below) must be done after this procedure.

- Preset VR1014 on the Local Unit to its center position, and connect the DC voltmeter between the anode of D1043 (+) and chassis ground.
- In USB mode, key the transmitter, and with no modulation, adjust VR1013 on the Local Unit for 0 V on the meter.

Transmitter IF Interstage Transformers

- With the inline wattmeter and 50- Ω dummy load connected to the antenna jack, set the **RF PWR** control fully ccw (minimum), and select the ALC meter function.
- Tune to 14.200 MHz in the CW mode, key the transmitter and adjust T2023 and T2026 ~ T2029, several times, for peak on the ALC meter or on the wattmeter (around 100 watts).

2nd Tx Mixer Balance

- Connect the RF attenuator and spectrum analyzer to the antenna jack, and set the **RF PWR** control fully ccw (minimum).
- Key the transmitter and adjust VR2007 on the RF Unit for minimum spurious 455 kHz on either side of 14.2 MHz (13.745 and 14.655 MHz).

Tx Drive

- Connect the DC voltmeter to the cathode of D1042 on the Local Unit, and set the **RF PWR** control fully clockwise.
- Adjust VR1015 on the Local Unit for 3.5 V on the meter.

Overcurrent ALC Turndown

The *Forward ALC (Max RF Output)* procedure below must be done after this.

- With the inline wattmeter and 50- Ω dummy load connected to the antenna jack, tune to 21.000 MHz, CW mode.
- Preset VR1012 on the Local Unit fully clockwise.
- Key the transmitter and adjust the **RF PWR** control for 140 watts on the wattmeter, and confirm at least 130 watts output on each band.

Forward ALC (Max RF Output)

Perform the previous procedure, and with the same setup, tune to 14.200 MHz. Key the transmitter and adjust VR1012 on the Local Unit for 110 watts on the wattmeter.

Ext. Antenna Tuner Tuning Power

- With the transceiver tuned to 14.200 MHz, CW mode, install a temporary jumper between TP1005 & TP1006 on the Local Unit.
- With the dummy load and wattmeter on the antenna jack, set the **RF PWR** control fully clockwise.
- Key the transmitter and adjust VR1010 on the Local Unit for 12 watts on the wattmeter. Then remove the jumper.

ALC Meter Sensitivity

The *Meter Full Scale* adjustment must be done before this procedure.

- With the transceiver tuned to 14.2 MHz, USB mode, inject 3-mV at 1 kHz from the AF generator to the microphone jack (pin 8).
- Key the transmitter, and adjust the **MIC** gain so the meter, set to ALC, just begins to deflect.

- Increase the injection level to 7.5 mV, and adjust VR3003 on the Display Unit so that the meter deflects to the top edge of the ALC zone.

PO Meter Calibration

- With the wattmeter and dummy load connected to the antenna jack, tune to 14.200 MHz, CW mode, and press the PO meter selector button.
- Key the transmitter and adjust the **RF PWR** control for 100 watts on the wattmeter. Then adjust VR3001 on the Display Unit so the PO meter also indicates 100 watts.

Drive

- Connect the DC voltmeter to the cathode of D1042 on the Local Unit, and set the **RF PWR** control fully clockwise (maximum).
- Adjust VR1015 on the Local Unit for 3.5 V on the voltmeter.

Reverse ALC (SWR Turndown)

- Connect the inline wattmeter and a 16.6- Ω dummy load (or three 50- Ω s in parallel) to the antenna jack, and set the **RF PWR** control fully clockwise (maximum).
- With the transceiver set to the CW mode on 14.200 MHz, key the transmitter and adjust VR1008 on the Local Unit for 40 ± 2 watts on the wattmeter.

SWR Meter Calibration

- With the 16.6- Ω dummy load (or three 50- Ω s in parallel) connected to the antenna jack, and the **RF PWR** control set fully clockwise (maximum), tune to 3.500 MHz, CW mode, and press the SWR meter selector button.
- Key the transmitter and adjust VR3002 on the Display Unit so the meter indicates 3.0 SWR.

SSB Modulator Balance

- With the transceiver tuned to 14.2 MHz, USB mode, connect the 50-dB attenuator and spectrum analyzer (or 50- Ω dummy load and sampling coupler) to the antenna jack. Alternatively, a separate receiver can

be used, with the transceiver connected to the dummy load.

- Set the **MIC** control fully ccw (minimum), key the transmitter, and adjust VR1020 on the Local Unit for minimum power output (carrier leakage, should be less than -50 dB) as indicated on the analyzer or external receiver.

AM Carrier Level

- Tune the transceiver to 3.5 MHz, AM mode, and connect the wattmeter and 50- Ω dummy load to the antenna jack.
- Set the **RF PWR** control fully ccw (minimum), key the transmitter, and with no modulation, adjust VR1018 on the Local Unit for 5 watts on the wattmeter.
- Turn the **RF PWR** control fully clockwise, press the ALC meter selector button, key the transmitter and confirm that the ALC meter deflects.

Speech Processor Check

- With the wattmeter and dummy load connected to the antenna jack and the **RF PWR** control fully clockwise, tune to 14.200 MHz, USB mode. Inject 2 mV at 1 kHz from the AF generator to the microphone jack.
- Set the **MIC** gain and **COMP** controls to their 12 o'clock positions, and press the **PROC** button. Then key the transmitter and confirm 100 watts on the wattmeter.

FM Carrier Frequency

- With the dummy load connected to the antenna jack, connect the frequency counter to TP2005 on the RF Unit. Tune to 14.200 MHz, FM mode, and set the **RF PWR** control fully ccw (minimum).
- Key the transmitter and adjust L2082 on the RF Unit for 70.455 MHz ± 50 Hz on the counter.

FM & CTCSS Deviation

- Connect the attenuator and linear detector to the antenna jack.
- Tune to 29.200 MHz, FM mode. Select the (default) 88.5-Hz subaudible tone, and

press the **RPT/T** switch to activate CTCSS operation.

- Key the transmitter and, with no microphone modulation, adjust VR2009 on the RF Unit for ± 0.7 -kHz deviation (± 100 Hz).
- Inject 10 mV at 1 kHz from the AF generator to pin 8 of the microphone jack, key the transmitter, and adjust VR2008 on the RF Unit for ± 2.3 -kHz deviation (± 100 Hz).
- Press the **RPT/T** switch again to turn it off.

FM Mic Gain

- With the attenuator and linear detector connected to the antenna jack, and with the transceiver tuned to 29.000 MHz, FM mode, inject 1.5 mV at 1 kHz from the AF generator to pin 8 of the microphone jack.
- Key the transmitter and adjust VR1022 on the Local Unit for ± 1.75 -kHz deviation (± 100 Hz).

Transmitter Carrier Point

- Temporarily solder across split pad JW3001 on the Display Unit.
- Connect the AF signal generator to pin 8 of the microphone jack, and set for 3 mV injection at 1 kHz. Set the transceiver to 14.200 MHz, USB mode.
- Press the **FAST** and **USB** buttons at the same time to activate the carrier-point-setting mode.

- Set the **MIC** gain and **RF PWR** controls fully clockwise (maximum), and press the **ALC** meter selector button.
- Key the transmitter and adjust the AF injection *frequency* for maximum output power, and then adjust the injection *level* to just above the point where the ALC meter indication no longer rises.
- Adjust the **MIC** gain control for 80 watts on the wattmeter.
- Tune the AF generator to 370 Hz, and adjust the transceiver frequency so that 20 watts output is obtained.
- Unkey the transmitter, press the **USB** mode button, and confirm that the display has returned to normal.
- Select LSB mode, and retune, if necessary, to 14.200 MHz. Then press the **FAST** and **USB** buttons at the same time to activate the carrier-point-setting mode again.
- Return the **MIC** gain control to maximum position, and return the injection level to 3 mV.
- Beginning with the 5th step above (“Key the transmitter...”), repeat the same adjustments while the transmitter is keyed. After unkeying the transmitter, press the **LSB** mode button, and confirm that the display has returned to normal.
- Remove the solder from JW3001.

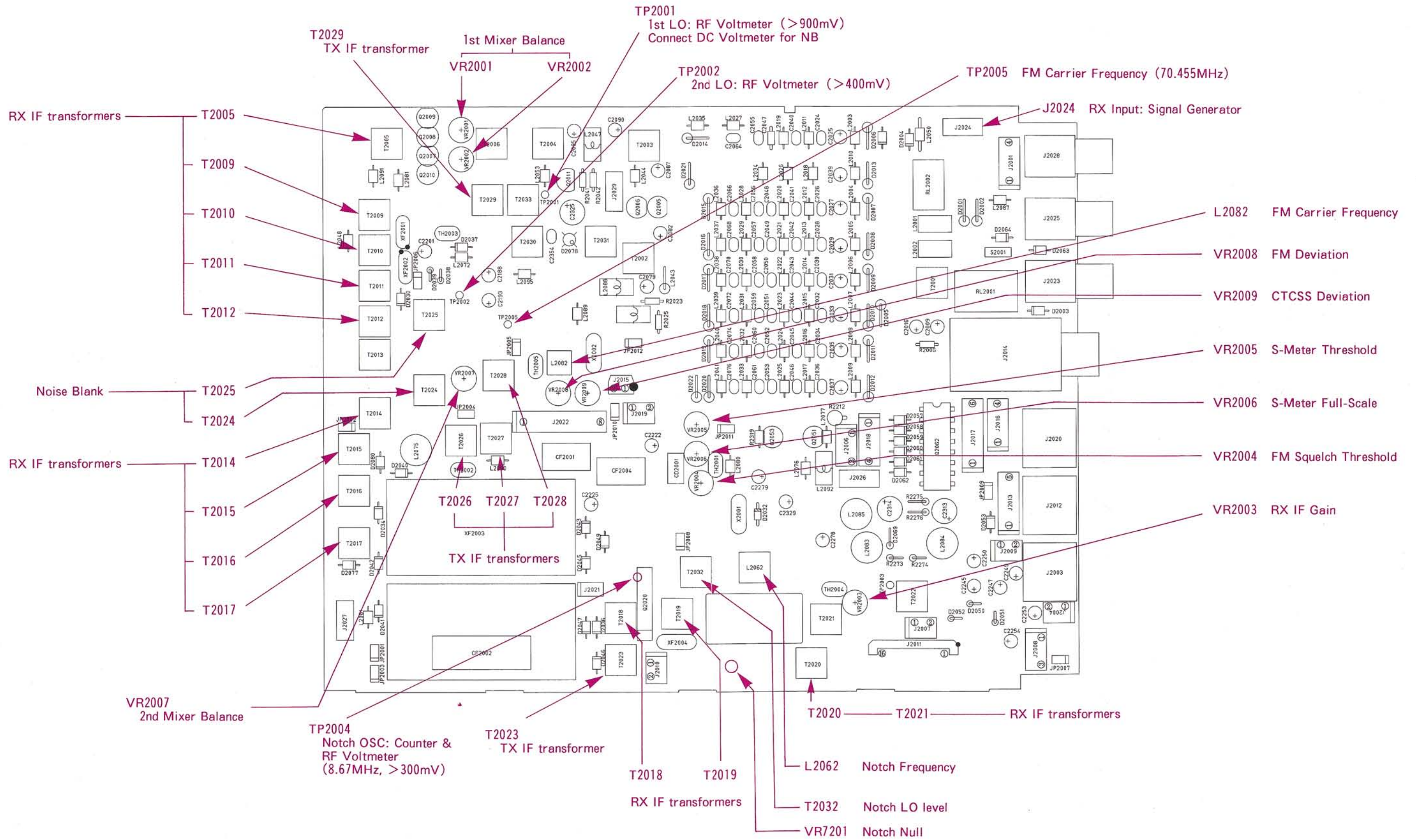

Local Unit Alignment Diagram

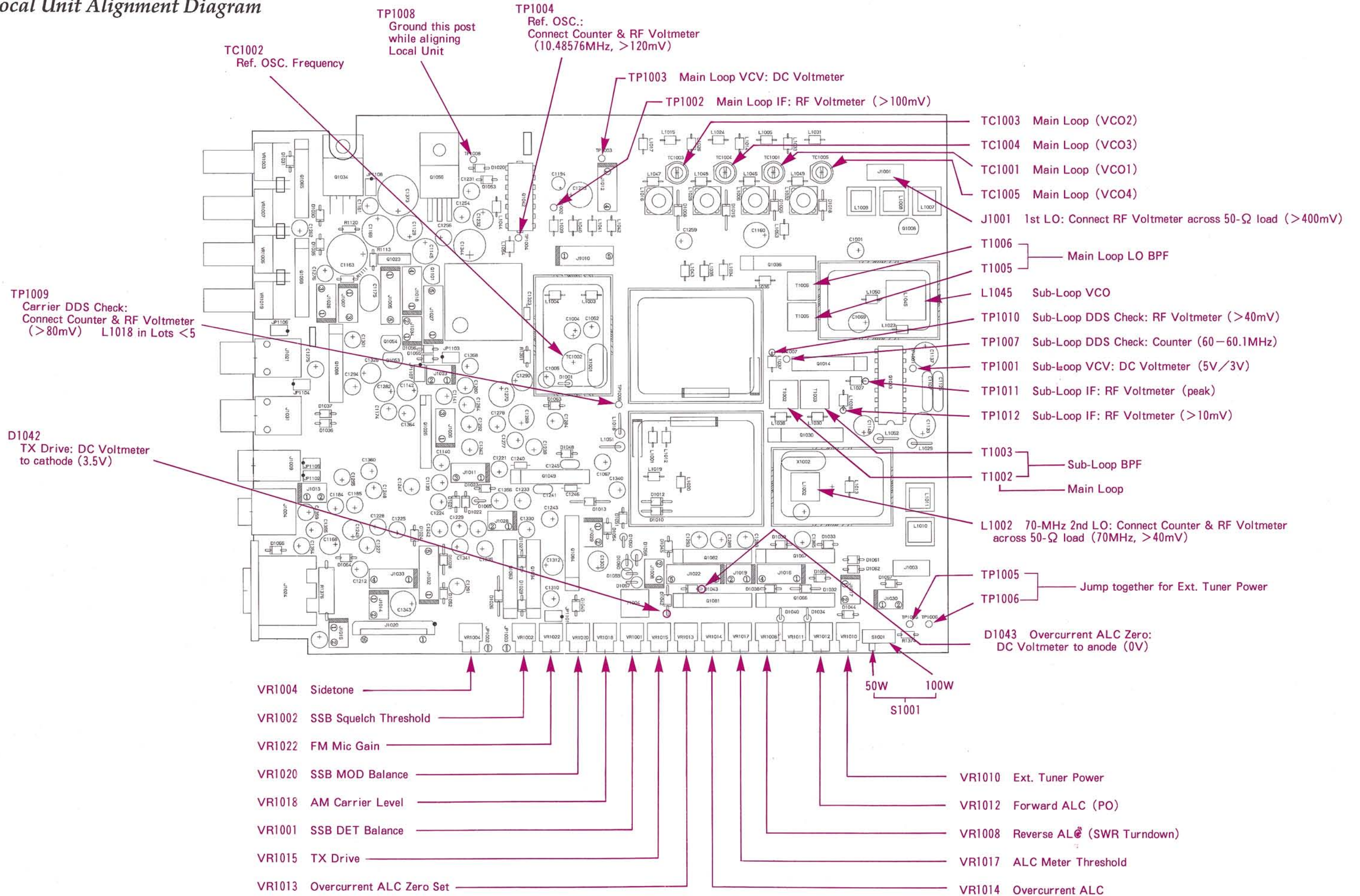

Block Diagram

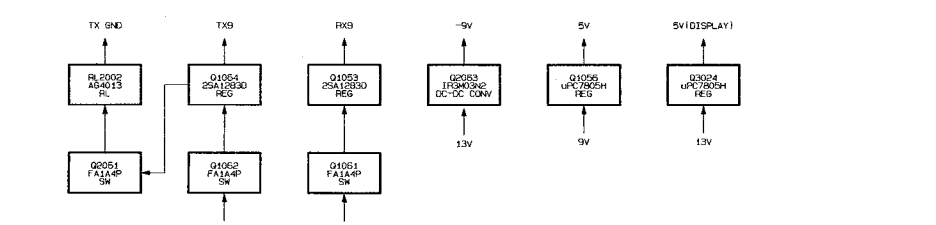
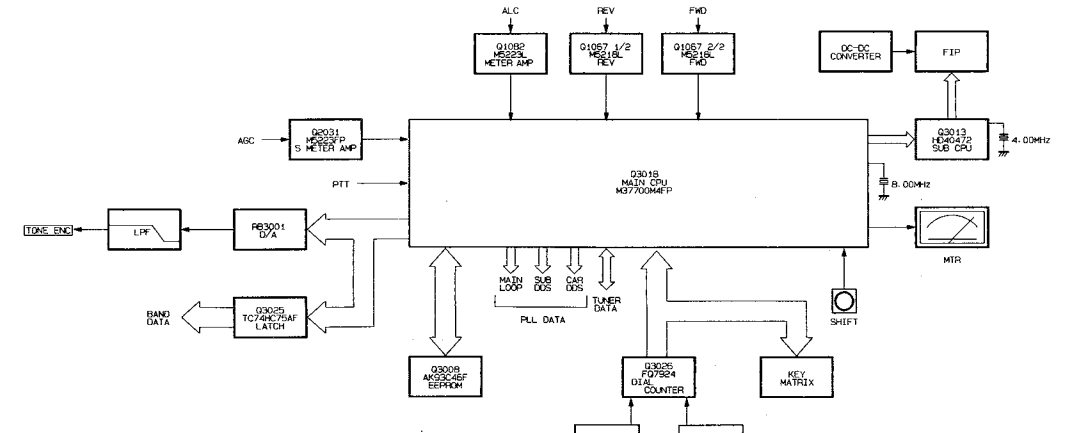
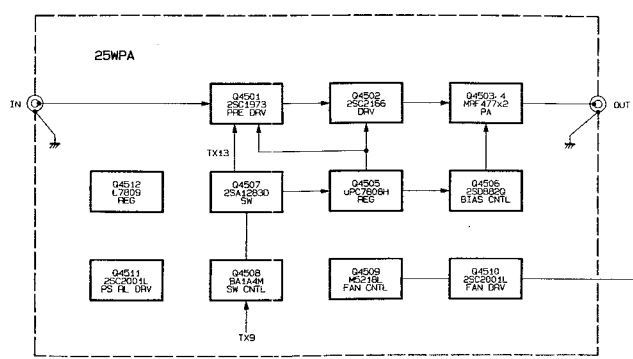
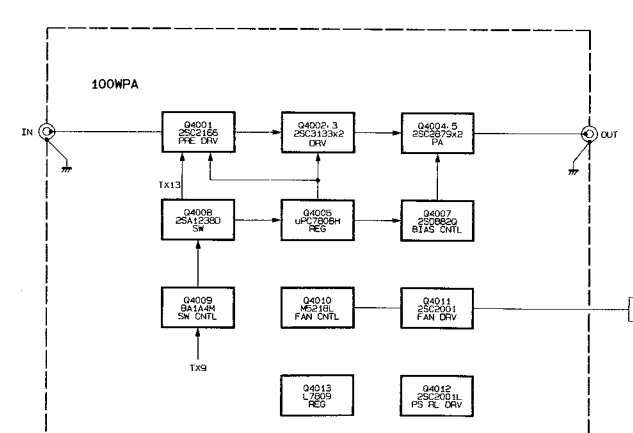
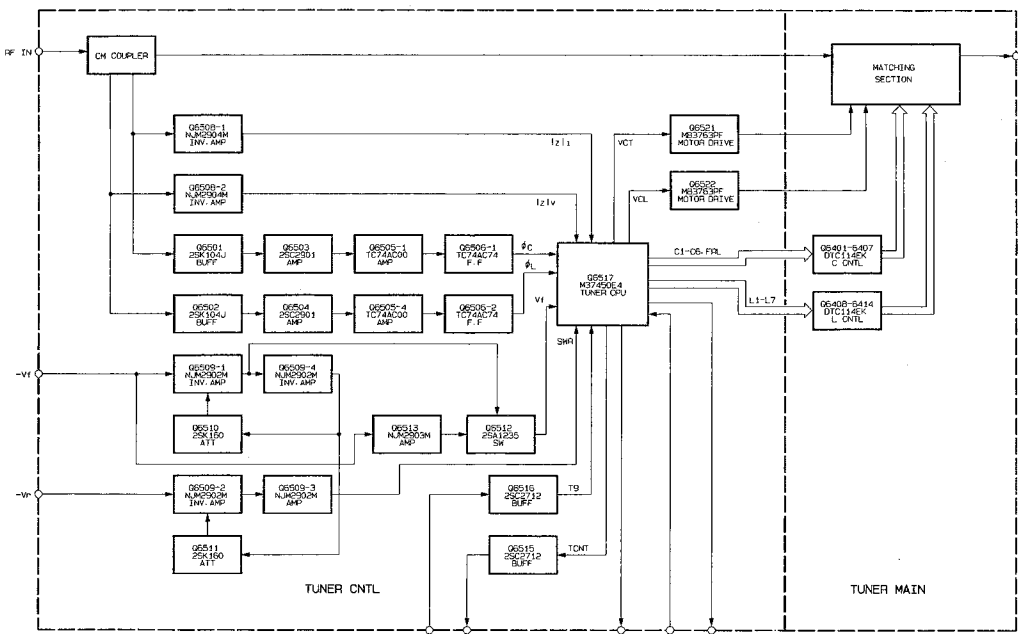
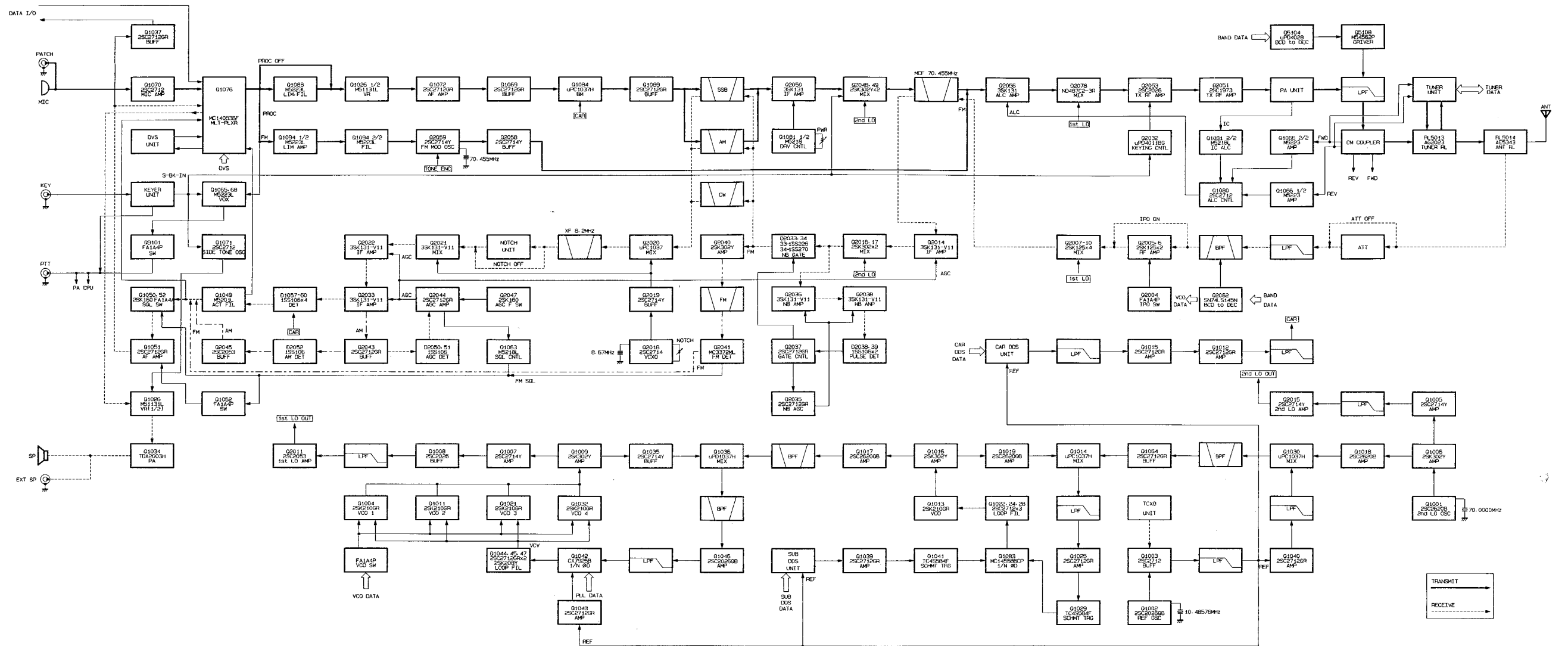

Interconnection Diagram

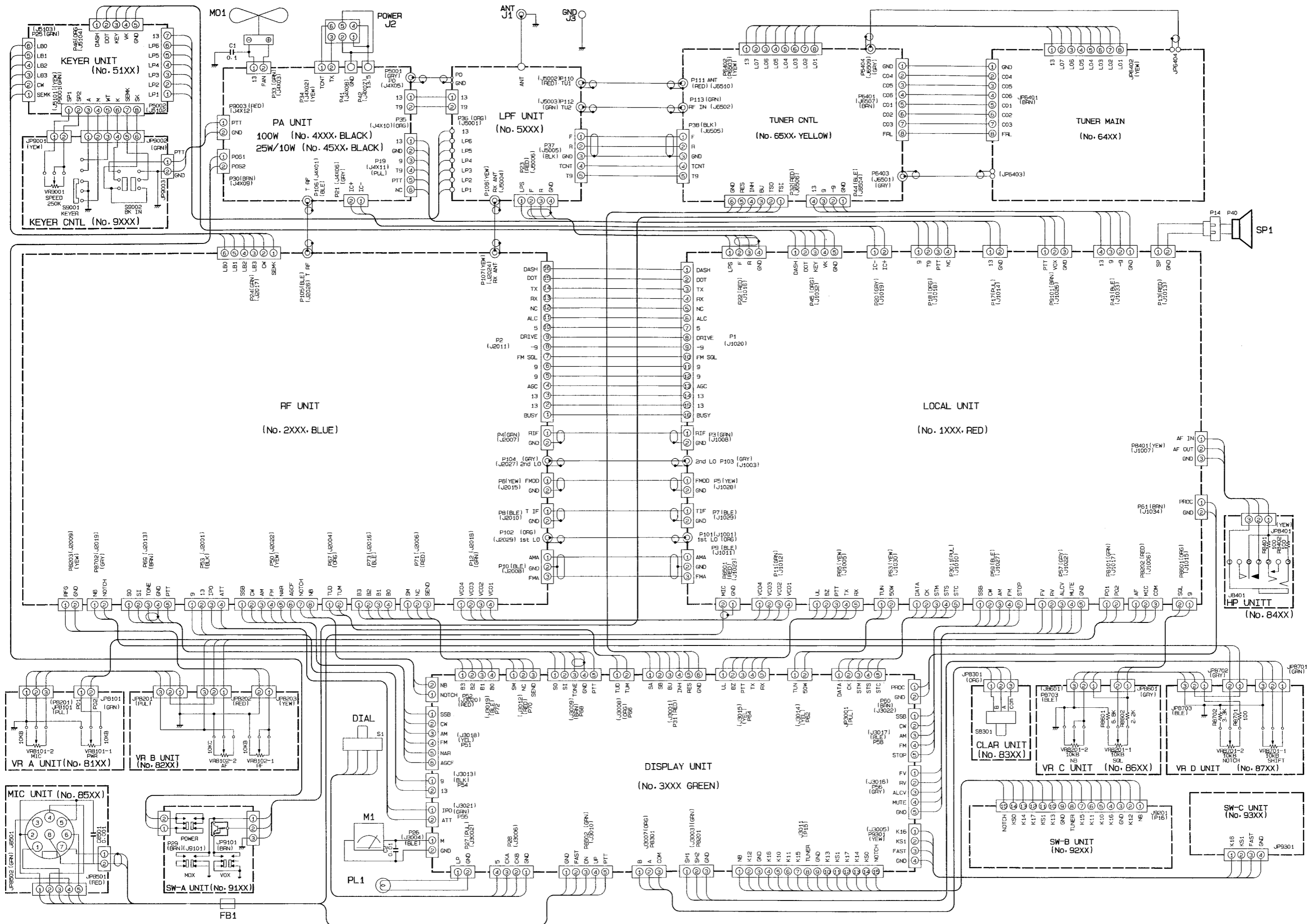

1 2 3 4 5 6 7

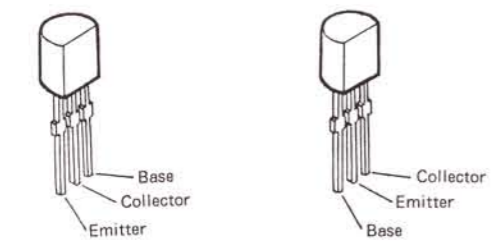

2SC2026 (Q1008)
2SD667C (Q1101)
2SA1283D (Q1053, 1054)

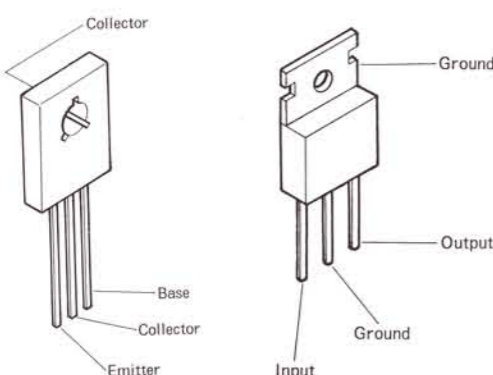

2SD882Q (Q1023)
μPC7805H (Q1056)

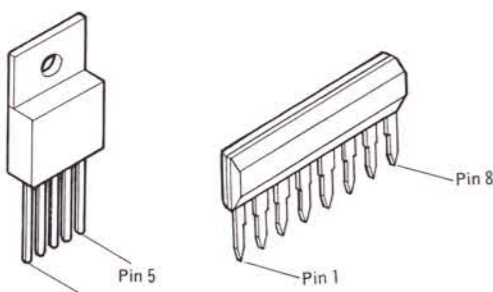

TDA2003H (Q1034)
M5223L (Q1065, 1068, 1082, 1088, 1094)

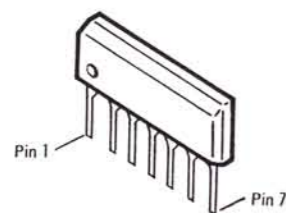

μPC1037H (Q1014, 1030, 1036, 1084)

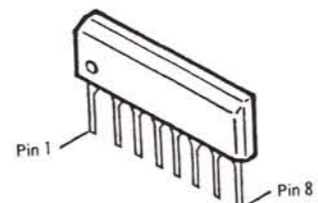

M5201L (Q1049)
M5218L (Q1063, 1066, 1067, 1081)

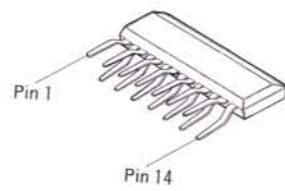

M51131L (Q1026)

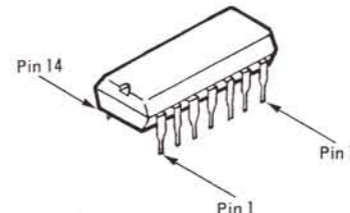

CX-7925B (Q1042)

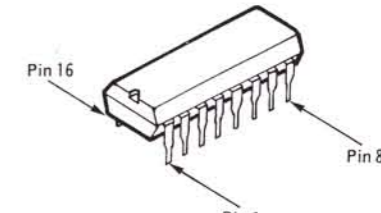

MC14568BCP (Q1033)

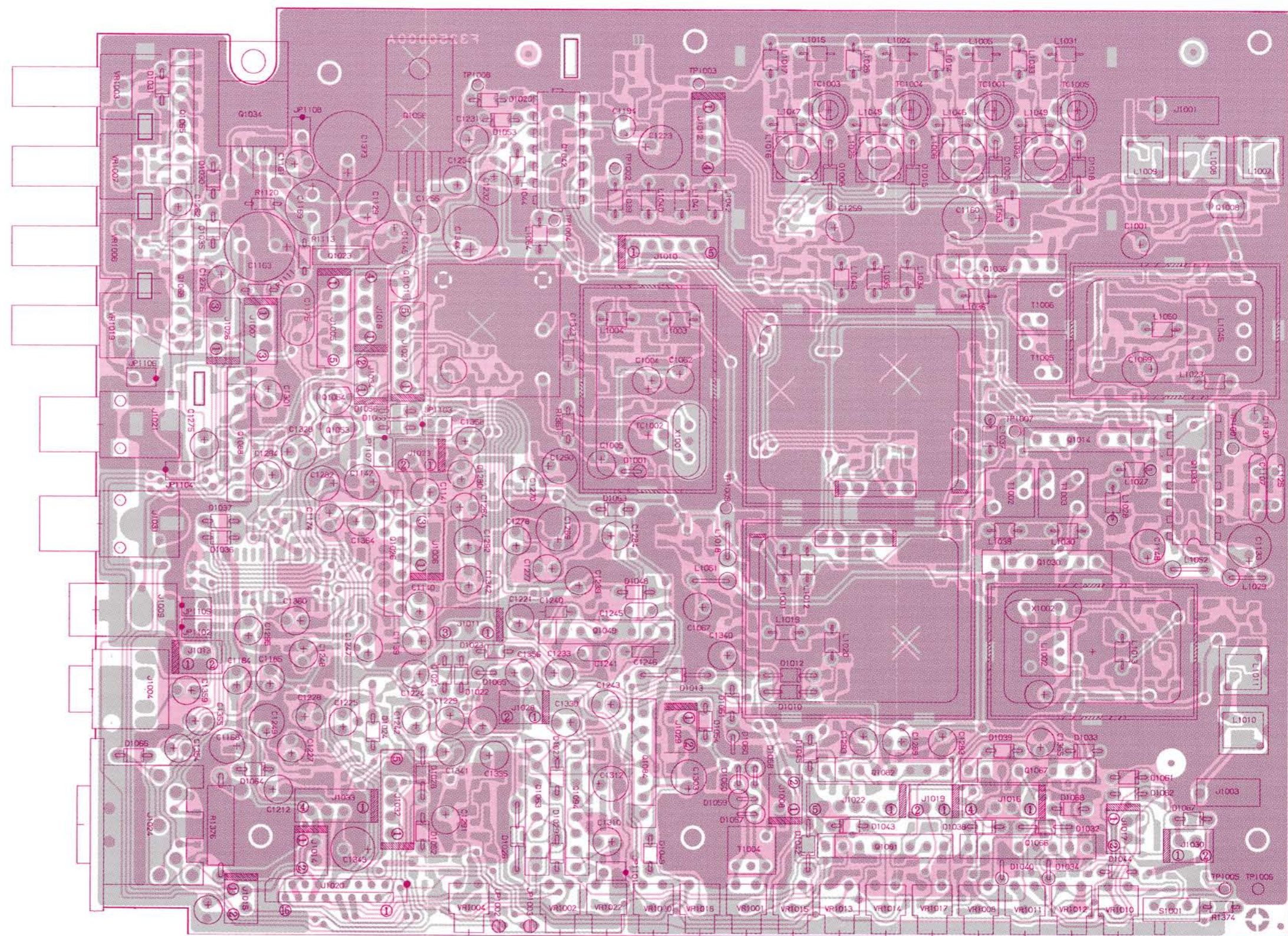

"component" side

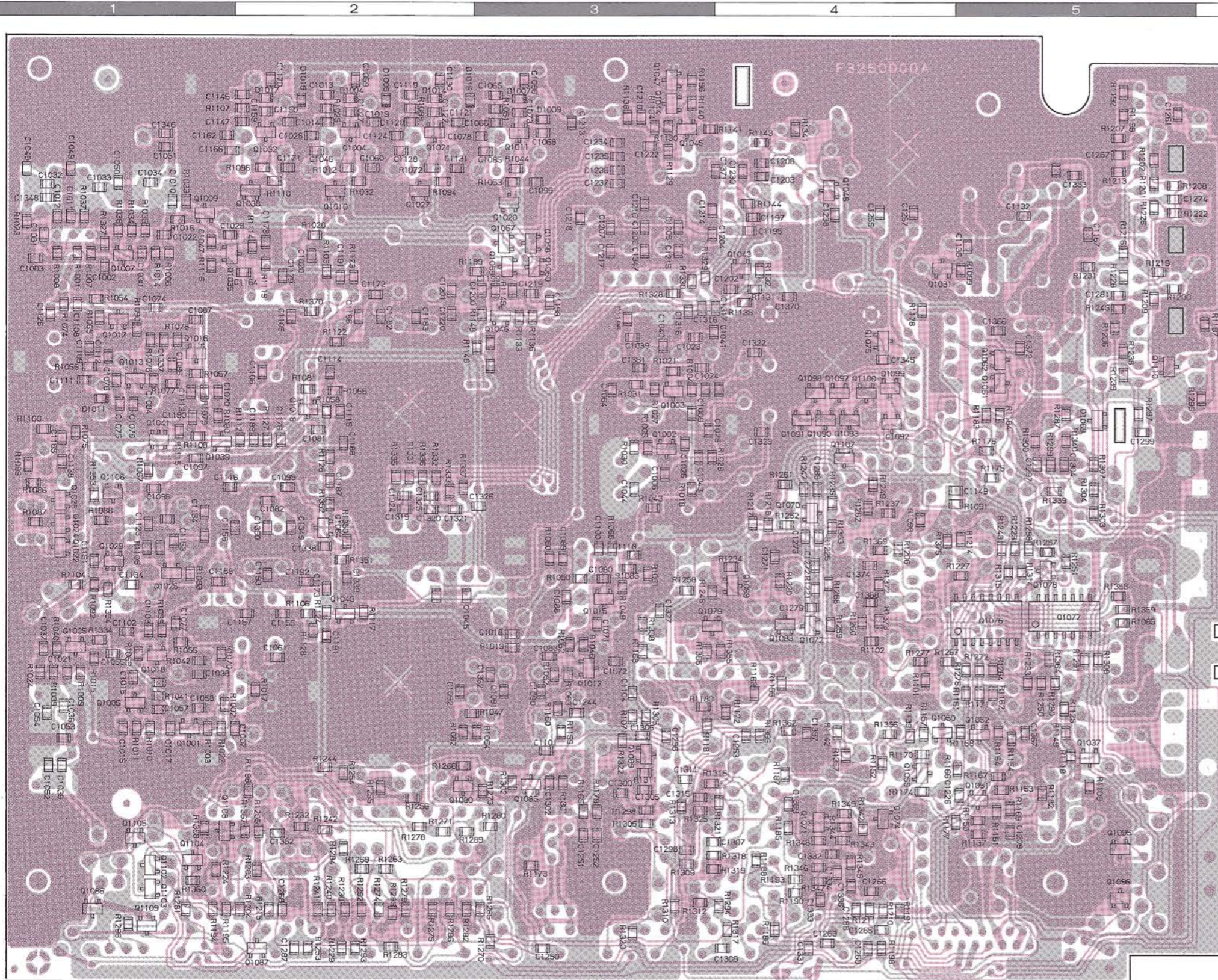

"chip-only" side

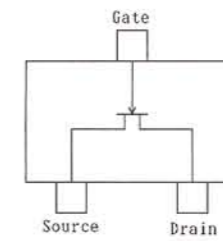
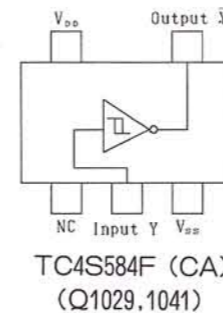
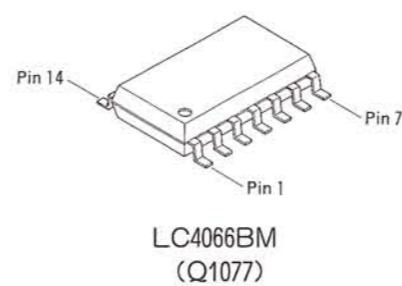
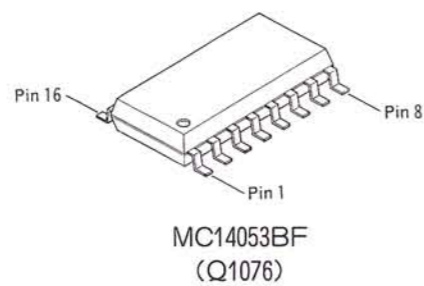

2SK160 (K6)
(Q1050, 1085)
2SK208Y (JY)
(Q1045)

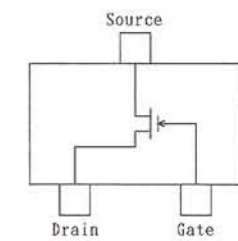

2SK210GR (YG)
(Q1004, 1011, 1013,
1021, 1032)
2SK302Y (TY)
(Q1006, 1009, 1016)

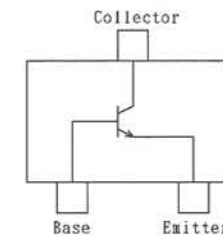

2SC2620QB (QB)
(Q1001, 1002, 1017,
1018, 1019, 1046)
2SC2712GR (LG)
(Q1003, 1012, 1015,
1022, 1024, 1025,
1028, 1031, 1037,
1039, 1040, 1043,
1044, 1047, 1051,
1064, 1069, 1070,
1071, 1072, 1080,
1089)

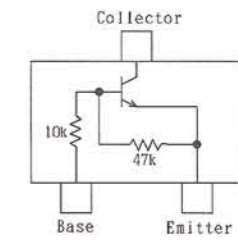

FA1A4P (L34)
(Q1010, 1020, 1027,
1038, 1048, 1052,
1055, 1061, 1062,
1074, 1075, 1078,
1079, 1083, 1086,
1087, 1095, 1096,
1097, 1098, 1099,
1100, 1104, 1105,
1106, 1107, 1108,
1109, 1110)

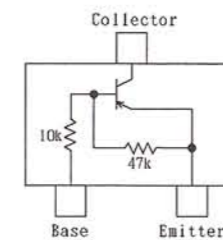

FN1A4P (M34)
(Q1057, 1058, 1059,
1060, 1090, 1091,
1092, 1093, 1102,
1103)

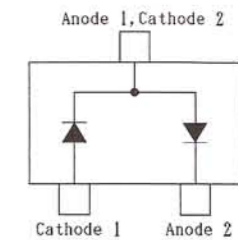

1SS226 (C3)
(D1069)

Local Unit

REF.	DESCRIPTION	VALUE	WV	TOL.	MFGR'S DESIG	YAESU P/N	VERS.	Addr
*** LOCAL UNIT ***								
	PCB W COMP.					CA0329002	PWR 10W	
	PCB W COMP.					CA0329003	PWR 25W	
	PCB W COMP.					CA0329004	PWR 100W	
	LOCAL, CAR DDS, SUB DDS UNIT W COMP.					CP3553002	PWR 10W	
	LOCAL, CAR DDS, SUB DDS UNIT W COMP.					CP3553003	PWR 25W	
	LOCAL, CAR DDS, SUB DDS UNIT W COMP.					CP3553004	PWR 100W	
	PCB W/O COMP.					F3250000A		
C 1001	AL. ELECTRO. CAP.	10uF	16V		16V100M4X7TR2	K46120004		
C 1002	CHIP CAP.	0.01uF	50V	B	GRM40B103M50PT	K22170817		
C 1003	CHIP CAP.	0.01uF	50V	B	GRM40B103M50PT	K22170817		
C 1004	AL. ELECTRO. CAP.	10uF	16V		16V100M4X7TR2	K46120004		
C 1005	AL. ELECTRO. CAP.	10uF	16V		16V100M4X7TR2	K46120004		
C 1006	CHIP CAP.	0.01uF	50V	B	GRM40B103M50PT	K22170817		
C 1007	CHIP CAP.	0.01uF	50V	B	GRM40B103M50PT	K22170817		
C 1009	CHIP CAP.	0.01uF	50V	B	GRM40B103M50PT	K22170817		
C 1010	CHIP CAP.	0.01uF	50V	B	GRM40B103M50PT	K22170817		
C 1011	CHIP CAP.	0.01uF	50V	B	GRM40B103M50PT	K22170817		
C 1012	CHIP CAP.	0.001uF	50V	B	GRM40B102M50PT	K22170805		
C 1013	CHIP CAP.	39pF	50V	CH	GRM40CH390J50PT	K22170225		
C 1014	CHIP CAP.	27pF	50V	UJ	GRM40UJ270J50PT	K22170321		
C 1015	CHIP CAP.	0.01uF	50V	B	GRM40B103M50PT	K22170817		
C 1016	CHIP CAP.	5pF	50V	CH	GRM40CH050C50PT	K22170206		
C 1017	CHIP CAP.	39pF	50V	UJ	GRM40UJ390J50PT	K22170325		
C 1018	CHIP CAP.	150pF	50V	CH	GRM40CH151J50PT	K22170239		
C 1019	CHIP CAP.	0.01uF	50V	B	GRM40B103M50PT	K22170817		
C 1020	CHIP CAP.	0.01uF	50V	B	GRM40B103M50PT	K22170817		
C 1021	CHIP CAP.	0.01uF	50V	B	GRM40B103M50PT	K22170817		
C 1022	CHIP CAP.	5pF	50V	CH	GRM40CH050C50PT	K22170206		
C 1023	CHIP CAP.	82pF	50V	CH	GRM40CH820J50PT	K22170233		
C 1024	CHIP CAP.	0.01uF	50V	B	GRM40B103M50PT	K22170817		
C 1025	CHIP CAP.	2pF	50V	CK	GRM40CK020C50PT	K22170203		
C 1026	CHIP CAP.	150pF	50V	CH	GRM40CH151J50PT	K22170239		
C 1027	CHIP CAP.	18pF	50V	UJ	GRM40UJ180J50PT	K22170317		
C 1028	CHIP CAP.	5pF	50V	CH	GRM40CH050C50PT	K22170206		
C 1029	CHIP CAP.	2pF	50V	CK	GRM40CK020C50PT	K22170203		
C 1030	CHIP CAP.	0.01uF	50V	B	GRM40B103M50PT	K22170817		
C 1031	CHIP CAP.	0.1uF	25V	F	GRM40F104Z25PT	K22141005		
C 1032	CHIP CAP.	4pF	50V	CH	GRM40CH040C50PT	K22170205		
C 1033	CHIP CAP.	5pF	50V	CH	GRM40CH050C50PT	K22170206		
C 1034	CHIP CAP.	2pF	50V	CK	GRM40CK020C50PT	K22170203		
C 1035	CHIP CAP.	15pF	50V	CH	GRM40CH150J50PT	K22170215		
C 1036	CHIP CAP.	5pF	50V	CH	GRM40CH050C50PT	K22170206		
C 1037	CHIP CAP.	0.01uF	50V	B	GRM40B103M50PT	K22170817		
C 1038	CHIP CAP.	0.001uF	50V	B	GRM40B102M50PT	K22170805		
C 1039	CHIP CAP.	390pF	50V	CH	GRM40CH391J50PT	K22170249		
C 1040	CHIP CAP.	390pF	50V	CH	GRM40CH391J50PT	K22170249		
C 1041	CHIP CAP.	390pF	50V	CH	GRM40CH391J50PT	K22170249		
C 1043	CHIP CAP.	100pF	50V	CH	GRM40CH101J50PT	K22170235		
C 1044	CHIP CAP.	22pF	50V	CH	GRM40CH220J50PT	K22170219		
C 1045	CHIP CAP.	10pF	50V	CH	GRM40CH100D50PT	K22170211		
C 1046	CHIP CAP.	5pF	50V	UJ	GRM40UJ050C50PT	K22170306		
C 1047	CHIP CAP.	1pF	50V	CK	GRM40CK010C50PT	K22170202		

Local Unit

REF.	DESCRIPTION	VALUE	WV	TOL.	MFGR'S DESIG	YAESU P/N	VERS.	Addr
C 1048	CHIP CAP.	22pF	50V	CH	GRM40CH220J50PT	K22170219		
C 1049	CHIP CAP.	47pF	50V	CH	GRM40CH470J50PT	K22170227		
C 1050	CHIP CAP.	56pF	50V	CH	GRM40CH560J50PT	K22170229		
C 1051	CHIP CAP.	27pF	50V	CH	GRM40CH270J50PT	K22170221		
C 1052	CHIP CAP.	68pF	50V	CH	GRM40CH680J50PT	K22170231		
C 1053	CHIP CAP.	82pF	50V	CH	GRM40CH820J50PT	K22170233		
C 1054	CHIP CAP.	56pF	50V	CH	GRM40CH560J50PT	K22170229		
C 1055	CHIP CAP.	2pF	50V	CK	GRM40CK020C50PT	K22170203		
C 1057	CHIP CAP.	2pF	50V	CK	GRM40CK020C50PT	K22170203		
C 1058	CHIP CAP.	39pF	50V	UJ	GRM40UJ390J50PT	K22170325		
C 1059	CHIP CAP.	0.001uF	50V	B	GRM40B102M50PT	K22170805		
C 1060	CHIP CAP.	0.01uF	50V	B	GRM40B103M50PT	K22170817		
C 1061	CHIP CAP.	150pF	50V	UJ	GRM40UJ151J50PT	K22170339		
C 1062	AL. ELECTRO. CAP.	10uF	16V		16V100M4X7TR2	K46120004		
C 1064	CHIP CAP.	0.01uF	50V	B	GRM40B103M50PT	K22170817		
C 1065	CHIP CAP.	27pF	50V	CH	GRM40CH270J50PT	K22170221		
C 1066	CHIP CAP.	27pF	50V	UJ	GRM40UJ270J50PT	K22170321		
C 1067	AL. ELECTRO. CAP.	1uF	50V		50V010M4X7TR2	K46170030		
C 1068	CHIP CAP.	0.01uF	50V	B	GRM40B103M50PT	K22170817		
C 1069	AL. ELECTRO. CAP.	47uF	16V		RC2-16V470M-T34	K46120010		
C 1070	CHIP CAP.	6pF	50V	CH	GRM40CH060D50PT	K22170207		
C 1071	CHIP CAP.	0.047uF	50V	F	GRM40F473Z50PT	K22171008		
C 1072	CHIP CAP.	0.047uF	50V	F	GRM40F473Z50PT	K22171008		
C 1073	CHIP CAP.	18pF	50V	UJ	GRM40UJ180J50PT	K22170317		
C 1074	CHIP CAP.	22pF	50V	CH	GRM40CH220J50PT	K22170219		
C 1075	CHIP CAP.	3pF	50V	CJ	GRM40CJ030C50PT	K22170204		
C 1076	CHIP CAP.	27pF	50V	UJ	GRM40UJ270J50PT	K22170321		
C 1077	CHIP CAP.	0.01uF	50V	B	GRM40B103M50PT	K22170817		
C 1078	CHIP CAP.	5pF	50V	CH	GRM40CH050C50PT	K22170206		
C 1079	CHIP CAP.	0.01uF	50V	B	GRM40B103M50PT	K22170817		
C 1080	CHIP CAP.	0.047uF	50V	F	GRM40F473Z50PT	K22171008		
C 1081	CHIP CAP.	0.01uF	50V	B	GRM40B103M50PT	K22170817		
C 1082	CHIP CAP.	1pF	50V	CK	GRM40CK010C50PT	K22170202		
C 1083	CHIP CAP.	0.047uF	50V	F	GRM40F473Z50PT	K22171008		
C 1084	CHIP CAP.	18pF	50V	UJ	GRM40UJ180J50PT	K22170317		
C 1085	CHIP CAP.	5pF	50V	UJ	GRM40UJ050C50PT	K22170306		
C 1086	CHIP CAP.	2pF	50V	CK	GRM40CK020C50PT	K22170203		
C 1087	CHIP CAP.	22pF	50V	CH	GRM40CH220J50PT	K22170219		
C 1088	CHIP CAP.	560pF	50V	B	GRM40B561M50PT	K22170802		
C 1089	CHIP CAP.	560pF	50V	B	GRM40B561M50PT	K22170802		
C 1090	CHIP CAP.	0.0012	50V	B	GRM40B122M50PT	K22170806		
C 1091	CHIP CAP.	0.0012	50V	B	GRM40B122M50PT	K22170806		
C 1092	CHIP CAP.	0.0012	50V	B	GRM40B122M50PT	K22170806		
C 1095	CHIP CAP.	0.001uF	50V	B	GRM40B102M50PT	K22170805		
C 1096	CHIP CAP.	0.047uF	50V	F	GRM40F473Z50PT	K22171008		
C 1097	CHIP CAP.	0.022uF	50V	B	GRM40B223M50PT	K22170821		
C 1098	CHIP CAP.	0.001uF	50V	B	GRM40B102M50PT	K22170805		
C 1099	CHIP CAP.	0.01uF	50V	B	GRM40B103M50PT	K22170817		
C 1100	CHIP CAP.	0.047uF	50V	F	GRM40F473Z50PT	K22171008		
C 1101	CHIP CAP.	22pF	50V	CH	GRM40CH220J50PT	K22170219		
C 1102	CHIP CAP.	0.01uF	50V	B	GRM40B103M50PT	K22170817		
C 1103	CHIP CAP.	0.01uF	50V	B	GRM40B103M50PT	K22170817		
C 1104	CHIP CAP.	0.01uF	50V	B	GRM40B103M50PT	K22170817		
C 1105	CHIP CAP.	0.001uF	50V	B	GRM40B102M50PT	K22170805		
C 1106	CHIP CAP.	1pF	50V	CK	GRM40CK010C50PT	K22170202		
C 1107	CERAMIC CAP.	0.1uF	25V	X	UAT10X104K-L45AE	K19149025		

REF.	DESCRIPTION	VALUE	WV	TOL.	MFGR'S DESIG	YAESU P/N	VERS.	Addr
C 1108	CHIP CAP.	0.01uF	50V	B	GRM40B103M50PT	K22170817		
C 1109	CHIP CAP.	0.01uF	50V	B	GRM40B103M50PT	K22170817		
C 1111	CHIP CAP.	10pF	50V	CH	GRM40CH100D50PT	K22170211		
C 1112	CHIP CAP.	22pF	50V	CH	GRM40CH220J50PT	K22170219		
C 1113	CHIP CAP.	0.01uF	50V	B	GRM40B103M50PT	K22170817		
C 1114	CHIP CAP.	0.01uF	50V	B	GRM40B103M50PT	K22170817		
C 1115	CHIP CAP.	0.01uF	50V	B	GRM40B103M50PT	K22170817		
C 1116	CHIP CAP.	0.022uF	50V	B	GRM40B223M50PT	K22170821		
C 1118	CHIP CAP.	0.1uF	25V	F	GRM40F104Z25PT	K22141005		
C 1119	CHIP CAP.	27pF	50V	CH	GRM40CH270J50PT	K22170221		
C 1120	CHIP CAP.	27pF	50V	UJ	GRM40UJ270J50PT	K22170321		
C 1121	CHIP CAP.	0.01uF	50V	B	GRM40B103M50PT	K22170817		
C 1122	CHIP CAP.	18pF	50V	UJ	GRM40UJ180J50PT	K22170317		
C 1123	CHIP CAP.	560pF	50V	B	GRM40B561M50PT	K22170802		
C 1124	CHIP CAP.	5pF	50V	CH	GRM40CH050C50PT	K22170206		
C 1125	CERAMIC CAP.	0.1uF	25V	X	UAT10X104K-L45AE	K19149025		
C 1126	CHIP CAP.	0.01uF	50V	B	GRM40B103M50PT	K22170817		
C 1128	CHIP CAP.	5pF	50V	UJ	GRM40UJ050C50PT	K22170306		
C 1129	AL. ELECTRO. CAP.	100uF	16V		16V101M6X7TR2	K46120007		
C 1130	CHIP CAP.	0.001uF	50V	B	GRM40B102M50PT	K22170805		
C 1131	CHIP CAP.	0.01uF	50V	B	GRM40B103M50PT	K22170817		
C 1132	CHIP CAP.	0.01uF	50V	B	GRM40B103M50PT	K22170817		
C 1133	AL. ELECTRO. CAP.	100uF	16V		16V101M6X7TR2	K46120007		
C 1134	CHIP CAP.	0.1uF	25V	F	GRM40F104Z25PT	K22141005		
C 1136	CHIP CAP.	0.01uF	50V	B	GRM40B103M50PT	K22170817		
C 1137	AL. ELECTRO. CAP.	100uF	16V		16V101M6X7TR2	K46120007		
C 1138	CHIP CAP.	0.0047uF	50V	B	GRM40B472M50PT	K22170813		
C 1139	AL. ELECTRO. CAP.	1uF	50V		50V010M4X7TR2	K46170030		
C 1140	AL. ELECTRO. CAP.	1uF	50V		50V010M4X7TR2	K46170030		
C 1141	AL. ELECTRO. CAP.	10uF	16V		16V100M4X7TR2	K46120004		
C 1142	AL. ELECTRO. CAP.	47uF	16V		RC2-16V470M-T34	K46120010		
C 1145	AL. ELECTRO. CAP.	100uF	16V		16V101M6X7TR2	K46120007		
C 1146	CHIP CAP.	33pF	50V	CH	GRM40CH330J50PT	K22170223		
C 1147	CHIP CAP.	27pF	50V	UJ	GRM40UJ270J50PT	K22170321		
C 1148	AL. ELECTRO. CAP.	47uF	16V		RC2-16V470M-T34	K46120010		
C 1149	CHIP CAP.	0.01uF	50V	B	GRM40B103M50PT	K22170817		
C 1150	CHIP CAP.	0.01uF	50V	B	GRM40B103M50PT	K22170817		
C 1151	CHIP CAP.	0.047uF	50V	F	GRM40F473Z50PT	K22171008		
C 1153	CHIP CAP.	0.0022uF	50V	B	GRM40B222M50PT	K22170809		
C 1154	CHIP CAP.	0.0022uF	50V	B	GRM40B222M50PT	K22170809		
C 1155	CHIP CAP.	0.01uF	50V	B	GRM40B103M50PT	K22170817		
C 1156	CHIP CAP.	0.01uF	50V	B	GRM40B103M50PT	K22170817		
C 1157	CHIP CAP.	0.01uF	50V	B	GRM40B103M50PT	K22170817		
C 1158	CHIP CAP.	27pF	50V	CH	GRM40CH270J50PT	K22170221		
C 1159	CHIP CAP.	18pF	50V	UJ	GRM40UJ180J50PT	K22170317		
C 1160	AL. ELECTRO. CAP.	100uF	16V		16V101M6X7TR2	K46120007		
C 1161	AL. ELECTRO. CAP.	1uF	50V		50V010M4X7TR2	K46170030		
C 1162	CHIP CAP.	5pF	50V	CH	GRM40CH050C50PT	K22170206		
C 1163	AL. ELECTRO. CAP.	470uF	16V		RE2-16V471M	K40129049		
C 1164	CHIP CAP.	0.001uF	50V	B	GRM40B102M50PT	K22170805		
C 1165	CHIP CAP.	0.01uF	50V	B	GRM40B103M50PT	K22170817		
C 1166	CHIP CAP.	5pF	50V	UJ	GRM40UJ050C50PT	K22170306		
C 1167	CHIP CAP.	0.01uF	50V	B	GRM40B103M50PT	K22170817		
C 1168	AL. ELECTRO. CAP.	100uF	10V		10V101M5X11TR5	K46100004		
C 1169	AL. ELECTRO. CAP.	470uF	6.3V		RE2-6V471M	K40089025		
C 1170	CHIP CAP.	0.001uF	50V	B	GRM40B102M50PT	K22170805		

Local Unit

REF.	DESCRIPTION	VALUE	WV	TOL.	MFGR'S DESIG	YAESU P/N	VERS.	Addr
C 1171	CHIP CAP.	0.01uF	50V	B	GRM40B103M50PT	K22170817		
C 1172	CHIP CAP.	33pF	50V	CH	GRM40CH330J50PT	K22170223		
C 1173	CHIP CAP.	0.01uF	50V	B	GRM40B103M50PT	K22170817		
C 1174	AL. ELECTRO. CAP.	1uF	50V		50V010M4X7TR2	K46170030		
C 1175	FILM CAP.	0.1	50V		50F2U104M	K50177104		
C 1176	CHIP CAP.	0.047uF	50V	F	GRM40F473Z50PT	K22171008		
C 1178	CHIP CAP.	0.01uF	50V	B	GRM40B103M50PT	K22170817		
C 1179	CHIP CAP.	0.01uF	50V	B	GRM40B103M50PT	K22170817		
C 1181	CHIP CAP.	0.01uF	50V	B	GRM40B103M50PT	K22170817		
C 1182	CHIP CAP.	3pF	50V	CJ	GRM40CJ030C50PT	K22170204		
C 1183	CHIP CAP.	10pF	50V	CH	GRM40CH100D50PT	K22170211		
C 1184	AL. ELECTRO. CAP.	1uF	50V		50V010M4X7TR2	K46170030		
C 1185	AL. ELECTRO. CAP.	1uF	50V		50V010M4X7TR2	K46170030		
C 1186	CHIP CAP.	33pF	50V	CH	GRM40CH330J50PT	K22170223		
C 1187	CHIP CAP.	180pF	50V	CH	GRM40CH181J50PT	K22170241		
C 1188	CHIP CAP.	180pF	50V	CH	GRM40CH181J50PT	K22170241		
C 1189	CHIP CAP.	0.1uF	25V	F	GRM40F104Z25PT	K22141005		
C 1190	CHIP CAP.	0.047uF	50V	F	GRM40F473Z50PT	K22171008		
C 1191	CHIP CAP.	0.01uF	50V	B	GRM40B103M50PT	K22170817		
C 1192	CHIP CAP.	27pF	50V	CH	GRM40CH270J50PT	K22170221		
C 1193	CHIP CAP.	47pF	50V	CH	GRM40CH470J50PT	K22170227		
C 1194	TANTALUM CAP.	0.68uF	35V		DN1VR68M1S	K70167684		
C 1195	CHIP CAP.	0.01uF	50V	B	GRM40B103M50PT	K22170817		
C 1196	CHIP CAP.	10pF	50V	CH	GRM40CH100D50PT	K22170211		
C 1197	CHIP CAP.	0.01uF	50V	B	GRM40B103M50PT	K22170817		
C 1198	CHIP CAP.	0.01uF	50V	B	GRM40B103M50PT	K22170817		
C 1199	CHIP CAP.	0.01uF	50V	B	GRM40B103M50PT	K22170817		
C 1200	CHIP CAP.	33pF	50V	CH	GRM40CH330J50PT	K22170223		
C 1201	CHIP CAP.	33pF	50V	CH	GRM40CH330J50PT	K22170223		
C 1202	CHIP CAP.	0.01uF	50V	B	GRM40B103M50PT	K22170817		
C 1203	CHIP CAP.	0.001uF	50V	B	GRM40B102M50PT	K22170805		
C 1204	CHIP CAP.	0.5pF	50V	CK	GRM40CK0R5C50PT	K22170201		
C 1205	CHIP CAP.	6pF	50V	CH	GRM40CHO60D50PT	K22170207		
C 1206	CHIP CAP.	4pF	50V	CH	GRM40CHO40C50PT	K22170205		
C 1207	CHIP CAP.	2pF	50V	CK	GRM40CK020C50PT	K22170203		
C 1208	CHIP CAP.	0.001uF	50V	B	GRM40B102M50PT	K22170805		
C 1209	CHIP CAP.	0.01uF	50V	B	GRM40B103M50PT	K22170817		
C 1210	CHIP CAP.	0.01uF	50V	B	GRM40B103M50PT	K22170817		
C 1212	AL. ELECTRO. CAP.	10uF	16V		16V100M4X7TR2	K46120004		
C 1213	CHIP CAP.	0.0047uF	50V	B	GRM40B472M50PT	K22170813		
C 1214	CHIP CAP.	6pF	50V	CH	GRM40CHO60D50PT	K22170207		
C 1215	CHIP CAP.	10pF	50V	CH	GRM40CH100D50PT	K22170211		
C 1216	CHIP CAP.	6pF	50V	CH	GRM40CHO60D50PT	K22170207		
C 1217	CHIP CAP.	4pF	50V	CH	GRM40CHO40C50PT	K22170205		
C 1218	CHIP CAP.	4pF	50V	CH	GRM40CHO40C50PT	K22170205		
C 1219	CHIP CAP.	0.01uF	50V	B	GRM40B103M50PT	K22170817		
C 1220	CHIP CAP.	3pF	50V	CJ	GRM40CJ030C50PT	K22170204		
C 1221	AL. ELECTRO. CAP.	2.2uF	50V		50V2R2M4X7TR2	K46170031		
C 1222	CHIP CAP.	0.01uF	50V	B	GRM40B103M50PT	K22170817		
C 1223	AL. ELECTRO. CAP.	100uF	16V		16V101M6X7TR2	K46120007		
C 1224	AL. ELECTRO. CAP.	0.22uF	50V		50VR22M4X7TR2	K46170027		
C 1225	AL. ELECTRO. CAP.	1uF	50V		50V010M4X7TR2	K46170030		
C 1226	CHIP CAP.	0.0022uF	50V	B	GRM40B222M50PT	K22170809		
C 1227	AL. ELECTRO. CAP.	1uF	50V		50V010M4X7TR2	K46170030		
C 1228	AL. ELECTRO. CAP.	1uF	50V		50V010M4X7TR2	K46170030		
C 1229	AL. ELECTRO. CAP.	2.2uF	50V		50V2R2M4X7TR2	K46170031		

REF.	DESCRIPTION	VALUE	WV	TOL.	MFGR'S DESIG	YAESU P/N	VERS.	Addr
C 1230	CHIP CAP.	0.01uF	50V	B	GRM40B103M50PT	K22170817		
C 1231	AL. ELECTRO. CAP.	3.3uF	50V		50V3R3M4X7TR2	K46170032		
C 1232	AL. ELECTRO. CAP.	47uF	16V		RC2-16V470M-T34	K46120010		
C 1233	AL. ELECTRO. CAP.	4.7uF	35V		35V4R7M4X7TR2	K46160004		
C 1234	CHIP CAP.	0.001uF	50V	B	GRM40B102M50PT	K22170805		
C 1235	CHIP CAP.	0.001uF	50V	B	GRM40B102M50PT	K22170805		
C 1236	CHIP CAP.	0.001uF	50V	B	GRM40B102M50PT	K22170805		
C 1237	CHIP CAP.	0.001uF	50V	B	GRM40B102M50PT	K22170805		
C 1238	CHIP CAP.	0.01uF	50V	B	GRM40B103M50PT	K22170817		
C 1239	AL. ELECTRO. CAP.	2.2uF	50V		50V2R2M4X7TR2	K46170031		
C 1240	CERAMIC CAP.	0.001uF	50V	B	UPO50B102K-A-B	K28179001		
C 1241	FILM CAP.	0.018	50V		50F2D183M	K50170025		
C 1243	AL. ELECTRO. CAP.	4.7uF	35V		35V4R7M4X7TR2	K46160004		
C 1244	CHIP CAP.	0.01uF	50V	B	GRM40B103M50PT	K22170817		
C 1245	FILM CAP.	0.027	50V		50F2D273M	K50170024		
C 1246	CERAMIC CAP.	0.0022uF	16V	X	EPO50X222M-A-B	K28129003		
C 1247	AL. ELECTRO. CAP.	1uF	50V		50V010M4X7TR2	K46170030		
C 1248	AL. ELECTRO. CAP.	1uF	50V		50V010M4X7TR2	K46170030		
C 1249	AL. ELECTRO. CAP.	47uF	16V		RC2-16V470M-T34	K46120010		
C 1250	CHIP CAP.	0.047uF	50V	F	GRM40F473Z50PT	K22171008		
C 1251	CHIP CAP.	0.047uF	50V	F	GRM40F473Z50PT	K22171008		
C 1252	CHIP CAP.	0.01uF	50V	B	GRM40B103M50PT	K22170817		
C 1253	CHIP CAP.	0.0068uF	50V	B	GRM40B682M50PT	K22170815		
C 1254	AL. ELECTRO. CAP.	10uF	16V		16V100M4X7TR2	K46120004		
C 1255	CHIP CAP.	0.1uF	25V	B	GRM40B104M25PT	K22140811		
C 1256	AL. ELECTRO. CAP.	10uF	16V		16V100M4X7TR2	K46120004		
C 1257	CHIP CAP.	0.1uF	25V	B	GRM40B104M25PT	K22140811		
C 1259	AL. ELECTRO. CAP.	10uF	16V		16V100M4X7TR2	K46120004		
C 1260	CHIP CAP.	0.047uF	50V	F	GRM40F473Z50PT	K22171008		
C 1261	CHIP CAP.	0.047uF	50V	F	GRM40F473Z50PT	K22171008		
C 1262	AL. ELECTRO. CAP.	2.2uF	50V		50V2R2M4X7TR2	K46170031		
C 1263	CHIP CAP.	0.01uF	50V	B	GRM40B103M50PT	K22170817		
C 1264	AL. ELECTRO. CAP.	1uF	50V		50V010M4X7TR2	K46170030		
C 1265	CHIP CAP.	0.01uF	50V	B	GRM40B103M50PT	K22170817		
C 1266	CHIP CAP.	0.01uF	50V	B	GRM40B103M50PT	K22170817		
C 1267	CHIP CAP.	0.1uF	25V	B	GRM40B104M25PT	K22140811		
C 1268	CHIP CAP.	100pF	50V	CH	GRM40CH101J50PT	K22170235		
C 1269	AL. ELECTRO. CAP.	220uF	10V		10V221M6X11TR5	K46100005		
C 1270	AL. ELECTRO. CAP.	220uF	10V		10V221M6X11TR5	K46100005		
C 1271	CHIP CAP.	0.01uF	50V	B	GRM40B103M50PT	K22170817		
C 1272	CHIP CAP.	0.01uF	50V	B	GRM40B103M50PT	K22170817		
C 1273	CHIP CAP.	0.01uF	50V	B	GRM40B103M50PT	K22170817		
C 1274	CHIP CAP.	0.047uF	50V	F	GRM40F473Z50PT	K22171008		
C 1275	AL. ELECTRO. CAP.	1uF	50V		50V010M4X7TR2	K46170030		
C 1276	AL. ELECTRO. CAP.	10uF	16V		16V100M4X7TR2	K46120004		
C 1277	AL. ELECTRO. CAP.	1uF	50V		50V010M4X7TR2	K46170030		
C 1278	AL. ELECTRO. CAP.	1uF	50V		50V010M4X7TR2	K46170030		
C 1279	CHIP CAP.	220pF	50V	CH	GRM40CH221J50PT	K22170243		
C 1280	AL. ELECTRO. CAP.	1uF	50V		50V010M4X7TR2	K46170030		
C 1281	CHIP CAP.	0.1uF	25V	B	GRM40B104M25PT	K22140811		
C 1282	AL. ELECTRO. CAP.	47uF	16V		RC2-16V470M-T34	K46120010		
C 1283	AL. ELECTRO. CAP.	10uF	16V		16V100M4X7TR2	K46120004		
C 1284	AL. ELECTRO. CAP.	4.7uF	35V		35V4R7M4X7TR2	K46160004		
C 1286	CHIP CAP.	0.001uF	50V	B	GRM40B102M50PT	K22170805		
C 1287	CHIP CAP.	100pF	50V	CH	GRM40CH101J50PT	K22170235		
C 1288	CHIP CAP.	0.047uF	50V	F	GRM40F473Z50PT	K22171008		

Local Unit

REF.	DESCRIPTION	VALUE	WV	TOL.	MFGR'S DESIG	YAESU P/N	VERS.	Addr
C 1289	AL. ELECTRO. CAP.	0.47uF	50V		50VR47M4X7TR2	K46170029		
C 1290	AL. ELECTRO. CAP.	22uF	16V		16V220M5X7TR2	K46120005		
C 1291	AL. ELECTRO. CAP.	10uF	16V		16V100M4X7TR2	K46120004		
C 1292	AL. ELECTRO. CAP.	10uF	16V		16V100M4X7TR2	K46120004		
C 1293	AL. ELECTRO. CAP.	0.22uF	50V		50VR22M4X7TR2	K46170027		
C 1294	AL. ELECTRO. CAP.	1uF	50V		50V010M4X7TR2	K46170030		
C 1295	AL. ELECTRO. CAP.	1uF	50V		50V010M4X7TR2	K46170030		
C 1296	CHIP CAP.	0.01uF	50V	B	GRM40B103M50PT	K22170817		
C 1297	CHIP CAP.	0.0068uF	50V	B	GRM40B682M50PT	K22170815		
C 1298	CHIP CAP.	0.01uF	50V	B	GRM40B103M50PT	K22170817		
C 1299	CHIP CAP.	0.022uF	50V	B	GRM40B223M50PT	K22170821		
C 1300	CHIP CAP.	0.01uF	50V	B	GRM40B103M50PT	K22170817		
C 1301	AL. ELECTRO. CAP.	1uF	50V		50V010M4X7TR2	K46170030		
C 1302	CHIP CAP.	0.01uF	50V	B	GRM40B103M50PT	K22170817		
C 1303	AL. ELECTRO. CAP.	47uF	16V		RC2-16V470M-T34	K46120010		
C 1304	CHIP CAP.	0.0033uF	50V	B	GRM40B332M50PT	K22170811		
C 1305	CHIP CAP.	0.01uF	50V	B	GRM40B103M50PT	K22170817		
C 1306	CHIP CAP.	0.047uF	50V	F	GRM40F473Z50PT	K22171008		
C 1307	CHIP CAP.	0.0068uF	50V	B	GRM40B682M50PT	K22170815		
C 1309	CHIP CAP.	0.0047uF	50V	B	GRM40B472M50PT	K22170813		
C 1310	AL. ELECTRO. CAP.	1uF	50V		50V010M4X7TR2	K46170030		
C 1311	CHIP CAP.	0.01uF	50V	B	GRM40B103M50PT	K22170817		
C 1312	AL. ELECTRO. CAP.	22uF	16V		16V220M5X7TR2	K46120005		
C 1315	CHIP CAP.	0.0033uF	50V	B	GRM40B332M50PT	K22170811		
C 1316	CHIP CAP.	220pF	50V	CH	GRM40CH221J50PT	K22170243		
C 1317	CHIP CAP.	0.001uF	50V	B	GRM40B102M50PT	K22170805		
C 1318	CHIP CAP.	0.001uF	50V	B	GRM40B102M50PT	K22170805		
C 1319	CHIP CAP.	100pF	50V	CH	GRM40CH101J50PT	K22170235		
C 1320	CHIP CAP.	100pF	50V	CH	GRM40CH101J50PT	K22170235		
C 1321	CHIP CAP.	100pF	50V	CH	GRM40CH101J50PT	K22170235		
C 1322	CHIP CAP.	33pF	50V	CH	GRM40CH330J50PT	K22170223		
C 1323	CERAMIC CAP.	0.01uF	16V	Y	EPO50Y103N-A	K28129001		
C 1324	CHIP CAP.	100pF	50V	CH	GRM40CH101J50PT	K22170235		
C 1325	CHIP CAP.	100pF	50V	CH	GRM40CH101J50PT	K22170235		
C 1326	CHIP CAP.	100pF	50V	CH	GRM40CH101J50PT	K22170235		
C 1327	CHIP CAP.	0.01uF	50V	B	GRM40B103M50PT	K22170817		
C 1328	AL. ELECTRO. CAP.	22uF	16V		16V220M5X7TR2	K46120005		
C 1329	CHIP CAP.	0.01uF	50V	B	GRM40B103M50PT	K22170817		
C 1330	AL. ELECTRO. CAP.	1uF	50V		50V010M4X7TR2	K46170030		
C 1331	CHIP CAP.	0.1uF	25V	B	GRM40B104M25PT	K22140811		
C 1332	CHIP CAP.	0.0068uF	50V	B	GRM40B682M50PT	K22170815		
C 1333	CHIP CAP.	0.0068uF	50V	B	GRM40B682M50PT	K22170815		
C 1334	CHIP CAP.	0.0068uF	50V	B	GRM40B682M50PT	K22170815		
C 1335	AL. ELECTRO. CAP.	1uF	50V		50V010M4X7TR2	K46170030		
C 1336	CHIP CAP.	0.047uF	50V	F	GRM40F473Z50PT	K22171008		
C 1337	CHIP CAP.	0.001uF	50V	B	GRM40B102M50PT	K22170805		
C 1338	CHIP CAP.	10pF	50V	CH	GRM40CH100D50PT	K22170211		
C 1339	CHIP CAP.	0.01uF	50V	B	GRM40B103M50PT	K22170817		
C 1340	AL. ELECTRO. CAP.	3.3uF	50V		50V3R3M4X7TR2	K46170032		
C 1341	AL. ELECTRO. CAP.	0.47uF	50V		50VR47M4X7TR2	K46170029		
C 1342	AL. ELECTRO. CAP.	1uF	50V		50V010M4X7TR2	K46170030		
C 1343	AL. ELECTRO. CAP.	100uF	16V		16V101M6X7TR2	K46120007		
C 1344	AL. ELECTRO. CAP.	330uF	16V		16V331M8X11TR5	K46120002		
C 1345	CHIP CAP.	0.01uF	50V	B	GRM40B103M50PT	K22170817		
C 1346	CHIP CAP.	0.047uF	50V	F	GRM40F473Z50PT	K22171008		
C 1347	CHIP CAP.	3pF	50V	CJ	GRM40CJ030C50PT	K22170204		

REF.	DESCRIPTION	VALUE	WV	TOL.	MFGR'S DESIG	YAESU P/N	VERS.	Addr
C 1348	CHIP CAP.	4pF	50V	CH	GRM40CH040C50PT	K22170205		
C 1349	CHIP CAP.	3pF	50V	CJ	GRM40CJ030C50PT	K22170204		
C 1350	CHIP CAP.	3pF	50V	CJ	GRM40CJ030C50PT	K22170204		
C 1351	CHIP CAP.	390pF	50V	CH	GRM40CH391J50PT	K22170249		
C 1352	CHIP CAP.	0.0012	50V	B	GRM40B122M50PT	K22170806		
C 1353	CHIP CAP.	0.01uF	50V	B	GRM40B103M50PT	K22170817		
C 1354	AL. ELECTRO. CAP.	1uF	50V		50V010M4X7TR2	K46170030		
C 1355	AL. ELECTRO. CAP.	1uF	50V		50V010M4X7TR2	K46170030		
C 1356	AL. ELECTRO. CAP.	10uF	16V		16V100M4X7TR2	K46120004		
C 1357	CHIP CAP.	0.01uF	50V	B	GRM40B103M50PT	K22170817		
C 1358	AL. ELECTRO. CAP.	10uF	16V		16V100M4X7TR2	K46120004		
C 1359	AL. ELECTRO. CAP.	1uF	50V		50V010M4X7TR2	K46170030		
C 1360	AL. ELECTRO. CAP.	1uF	50V		50V010M4X7TR2	K46170030		
C 1362	CHIP CAP.	0.001uF	50V	B	GRM40B102M50PT	K22170805		
C 1364	AL. ELECTRO. CAP.	1uF	50V		50V010M4X7TR2	K46170030		
C 1365	AL. ELECTRO. CAP.	4.7uF	35V		35V4R7M4X7TR2	K46160004		
C 1366	CHIP CAP.	0.047uF	50V	F	GRM40F473Z50PT	K22171008		
C 1367	CHIP CAP.	0.0047uF	50V	B	GRM40B472M50PT	K22170813		
C 1368	CHIP CAP.	0.047uF	50V	F	GRM40F473Z50PT	K22171008		
C 1369	CHIP CAP.	0.01uF	50V	B	GRM40B103M50PT	K22170817		
C 1370	CHIP CAP.	22pF	50V	CH	GRM40CH220J50PT	K22170219		
C 1371	CHIP CAP.	22pF	50V	CH	GRM40CH220J50PT	K22170219		
C 1372	CHIP CAP.	0.01uF	50V	B	GRM40B103M50PT	K22170817		
C 1373	AL. ELECTRO. CAP.	470uF	16V		RE2-16V471M	K40129049		
C 1374	CHIP CAP.	0.047uF	50V	F	GRM40F473Z50PT	K22171008		
D 1001	DIODE				HZ5B	G2090242		
D 1004	DIODE				HVU306A5TRF	G2070132		
D 1005	DIODE				1SS53T1	G2060002		
D 1006	DIODE				HVU306A5TRF	G2070132		
D 1007	DIODE				HVU306A5TRF	G2070132		
D 1008	DIODE				1SS53T1	G2060002		
D 1009	DIODE				HVU306A5TRF	G2070132		
D 1010	DIODE				1SS270TJ	G2060004		
D 1011	DIODE				HVU200-5TRP	G2070090		
D 1012	DIODE				1SS270TJ	G2060004		
D 1013	DIODE				1SS270TJ	G2060004		
D 1014	DIODE				HVU306A5TRF	G2070132		
D 1015	DIODE				1SS53T1	G2060002		
D 1016	DIODE				HVU306A5TRF	G2070132		
D 1017	DIODE				HVU306A5TRF	G2070132		
D 1018	DIODE				1SS53T1	G2060002		
D 1019	DIODE				HVU306A5TRF	G2070132		
D 1020	DIODE				1SS270TJ	G2060004		
D 1021	DIODE				1SS270TJ	G2060004		
D 1022	DIODE				1SS270TJ	G2060004		
D 1023	DIODE				1SS270TJ	G2060004		
D 1024	DIODE				1SS270TJ	G2060004		
D 1026	DIODE				1SS270TJ	G2060004		
D 1027	DIODE				1SS270TJ	G2060004		
D 1028	DIODE				1SS270TJ	G2060004		
D 1029	DIODE				1SS270TJ	G2060004		
D 1030	DIODE				1SS270TJ	G2060004		
D 1031	DIODE				1SS270TJ	G2060004		
D 1032	DIODE				1SS270TJ	G2060004		
D 1033	DIODE				1SS270TJ	G2060004		

Local Unit

REF.	DESCRIPTION	VALUE	WV	TOL.	MFR'S DESIG	YAESU P/N	VERS.	Addr
D 1034	DIODE				HZ12B2	G2090149		
D 1035	DIODE				1SS270TJ	G2060004		
D 1036	DIODE				1SS270TJ	G2060004		
D 1037	DIODE				1SS270TJ	G2060004		
D 1038	DIODE				1SS270TJ	G2060004		
D 1039	DIODE				1SS270TJ	G2060004		
D 1040	DIODE				HZ12B2	G2090149		
D 1042	DIODE				1SS270TJ	G2060004		
D 1043	DIODE				1SS270TJ	G2060004		
D 1044	VARISTOR				MV-12 (KB265)	G9090007		
D 1045	DIODE				1SS270TJ	G2060004		
D 1048	DIODE				1SS270TJ	G2060004		
D 1049	DIODE				1SS270TJ	G2060004		
D 1050	DIODE				HZ7C1	G2090405		
D 1051	DIODE				1SS270TJ	G2060004		
D 1052	DIODE				1SS270TJ	G2060004		
D 1053	DIODE				1SS270TJ	G2060004		
D 1054	DIODE				1SS270TJ	G2060004		
D 1055	DIODE				1SS270TJ	G2060004		
D 1056	DIODE				1SS270TJ	G2060004		
D 1057	DIODE				1SS106	G2090244		
D 1058	DIODE				1SS106	G2090244		
D 1059	DIODE				1SS106	G2090244		
D 1060	DIODE				1SS106	G2090244		
D 1061	DIODE				1SS270TJ	G2060004		
D 1062	DIODE				1SS270TJ	G2060004		
D 1063	DIODE				1SS270TJ	G2060004		
D 1064	DIODE				1SS270TJ	G2060004		
D 1065	DIODE				RD6. 2EB2	G2090246		
D 1066	DIODE				1SS270TJ	G2060004		
D 1067	DIODE				1SS270TJ	G2060004		
D 1068	DIODE				1SS270TJ	G2060004		
D 1069	DIODE				1SS226 TE85R	G2070003		
J 1001	CONNECTOR				TMP-J01X-A2	P1090255		
J 1003	CONNECTOR				TMP-J01X-A2	P1090255		
J 1004	CONNECTOR				HSJ0916-01-010	P1090546		
J 1005	CONNECTOR				SC25-05WS	P0090624		
J 1006	CONNECTOR				SC25-03WS	P0090622		
J 1007	CONNECTOR				SC25-03WS	P0090622		
J 1008	CONNECTOR				SC25-02WS	P0090621		
J 1009	CONNECTOR				SG8035#01	P1090350		
J 1010	CONNECTOR				SC25-05WS	P0090624		
J 1011	CONNECTOR				SC25-03WS	P0090622		
J 1012	CONNECTOR				SC25-04WS	P0090623		
J 1013	CONNECTOR				SC25-02WS	P0090621		
J 1014	CONNECTOR				SC25-02WS	P0090621		
J 1015	CONNECTOR				SC25-02WS	P0090621		
J 1016	CONNECTOR				SC25-04WS	P0090623		
J 1017	CONNECTOR				SC25-02WS	P0090621		
J 1018	CONNECTOR				SC25-04WS	P0090623		
J 1019	CONNECTOR				SC25-02WS	P0090621		
J 1020	CONNECTOR				52030-1610	P1090657		
J 1021	CONNECTOR				S-Q3097-01	P1090348		
J 1022	CONNECTOR				SC25-05WS	P0090624		
J 1023	CONNECTOR				SC25-02WS	P0090621		

Local Unit

REF.	DESCRIPTION	VALUE	WV	TOL.	MFGR'S DESIG	YAESU P/N	VERS.	Addr
J 1024	CONNECTOR				TCS5073-17-4151	P1090648		
J 1026	CONNECTOR				SC25-03WS	P0090622		
J 1027	CONNECTOR				SC25-05WS	P0090624		
J 1028	CONNECTOR				SC25-02WS	P0090621		
J 1029	CONNECTOR				SC25-02WS	P0090621		
J 1030	CONNECTOR				SC25-02WS	P0090621		
J 1031	CONNECTOR				S-Q3097-01	P1090348		
J 1032	CONNECTOR				SC25-05WS	P0090624		
J 1033	CONNECTOR				SC25-04WS	P0090623		
J 1034	CONNECTOR				SC25-02WS	P0090621		
L 1001	M. RFC	0. 82uH			LAP02TAR82K	L1790045		
L 1002	COIL				0. 29U R12-6493X	L0021382		
L 1003	M. RFC	0. 68uH			LAP02TAR68K	L1790044		
L 1004	M. RFC	0. 68uH			LAP02TAR68K	L1790044		
L 1005	M. RFC	4. 7uH			LAP02TA4R7K	L1790054		
L 1006	COIL				S7-M1 R12-L722H	L0190181		
L 1007	COIL				4. 5T3. 5D0. 6UEW R	L0021819A		
L 1008	COIL				5. 5T3. 5D0. 6UEW R	L0021820A		
L 1009	COIL				5. 5T3. 5D0. 6UEW R	L0021820A		
L 1010	COIL				6. 5T3. 5D0. 6UEW R	L0021821A		
L 1011	COIL				5. 5T3. 5D0. 6UEW R	L0021820A		
L 1012	M. RFC	0. 82uH			LAP02TAR82K	L1790045		
L 1013	M. RFC	1uH			LAP02TA1R0K	L1790046		
L 1014	M. RFC	4. 7uH			LAP02TA4R7K	L1790054		
L 1015	M. RFC	4. 7uH			LAP02TA4R7K	L1790054		
L 1016	COIL				S7-M1 R12-L722G	L0190180		
L 1017	M. RFC	4. 7uH			LAP02TA4R7K	L1790054		
L 1018	M. RFC	330uH			LAL03VB331K	L1790158		
L 1019	M. RFC	100uH			LAP02TA101K	L1790070		
L 1020	M. RFC	100uH			LAP02TA101K	L1790070		
L 1023	M. RFC	4. 7uH			LAP02TA4R7K	L1790054		
L 1024	M. RFC	4. 7uH			LAP02TA4R7K	L1790054		
L 1025	COIL				S7-M1 R12-L722F	L0190179		
L 1026	M. RFC	4. 7uH			LAP02TA4R7K	L1790054		
L 1027	M. RFC	100uH			LAP02TA101K	L1790070		
L 1028	M. RFC	120uH			LAP02TA121K	L1790071		
L 1029	M. RFC	1mH			LAL03VB102K	L1790164		
L 1030	M. RFC	12uH			LAP02TA120K	L1790059		
L 1031	M. RFC	4. 7uH			LAP02TA4R7K	L1790054		
L 1032	COIL				S7-M1 R12-L722E	L0190178		
L 1033	M. RFC	4. 7uH			LAP02TA4R7K	L1790054		
L 1034	M. RFC	2. 2uH			LAP02TA2R2K	L1790050		
L 1035	M. RFC	2. 2uH			LAP02TA2R2K	L1790050		
L 1036	M. RFC	5. 6uH			LAP02TA5R6K	L1790055		
L 1037	M. RFC	120uH			LAP02TA121K	L1790071		
L 1038	M. RFC	12uH			LAP02TA120K	L1790059		
L 1039	M. RFC	1. 8u			LAP02TA1R8K	L1790049		
L 1040	M. RFC	1. 5u			LAP02TA1R5K	L1790048		
L 1041	M. RFC	1. 2u			LAP02TA1R2K	L1790047		
L 1042	M. RFC	1. 5u			LAP02TA1R5K	L1790048		
L 1043	M. RFC	5. 6uH			LAP02TA5R6K	L1790055		
L 1044	M. RFC	100uH			LAP02TA101K	L1790070		
L 1045	COIL				0. 42U	L0021399		
L 1046	M. RFC	3. 3uH			LAP02TA3R3K	L1790052		
L 1047	M. RFC	3. 3uH			LAP02TA3R3K	L1790052		

Local Unit

REF.	DESCRIPTION	VALUE	WV	TOL.	MFGR'S DESIG	YAESU P/N	VERS.	Addr
L 1048	M. RFC	2.7u			LAP02TA2R7K	L1790051		
L 1049	M. RFC	2.7u			LAP02TA2R7K	L1790051		
L 1050	M. RFC	2.7u			LAP02TA2R7K	L1790051		
L 1051	M. RFC	1mH			LAL03VB102K	L1790164		
L 1052	M. RFC	1mH			LAL03VB102K	L1790164		
L 1053	M. RFC	100uH			LAP02TA101K	L1790070		
L 1054	M. RFC	10uH			LAP02TA100K	L1790058		
Q 1001	TRANSISTOR				2SC2620QBTR	G3326207B		c1
Q 1002	TRANSISTOR				2SC2620QBTR	G3326207B		b3
Q 1003	TRANSISTOR				2SC2712GR TE85R	G3327127G		b3
Q 1004	FET				2SK210GR TE85R	G3802107G		a2
Q 1005	TRANSISTOR				2SC2714YTE85R	G3327147Y		c1
Q 1006	FET				2SK302Y TE85R	G3803027Y		c1
Q 1007	TRANSISTOR				2SC2714YTE85R	G3327147Y		a1
Q 1008	TRANSISTOR				2SC2026	G3320260		A7
Q 1009	FET				2SK302Y TE85R	G3803027Y		a1
Q 1010	TRANSISTOR				FA1A4P-T2B	G3070006		a2
Q 1011	FET				2SK210GR TE85R	G3802107G		a3
Q 1012	TRANSISTOR				2SC2712GR TE85R	G3327127G		c3
Q 1013	FET				2SK210GR TE85R	G3802107G		b1
Q 1014	IC				UPC1037H	G1090101		B7
Q 1015	TRANSISTOR				2SC2712GR TE85R	G3327127G		c3
Q 1016	FET				2SK302Y TE85R	G3803027Y		b1
Q 1017	TRANSISTOR				2SC2620QBTR	G3326207B		b1
Q 1018	TRANSISTOR				2SC2620QBTR	G3326207B		c1
Q 1019	TRANSISTOR				2SC2620QBTR	G3326207B		b2
Q 1020	TRANSISTOR				FA1A4P-T2B	G3070006		a3
Q 1021	FET				2SK210GR TE85R	G3802107G		a2
Q 1022	TRANSISTOR				2SC2712GR TE85R	G3327127G		c1
Q 1023	TRANSISTOR				2SD882Q	G3408820Q		B4
Q 1024	TRANSISTOR				2SC2712GR TE85R	G3327127G		c1
Q 1025	TRANSISTOR				2SC2712GR TE85R	G3327127G		c1
Q 1026	IC				M51131L	G1091077		C4
Q 1027	TRANSISTOR				FA1A4P-T2B	G3070006		a2
Q 1028	TRANSISTOR				2SC2712GR TE85R	G3327127G		c1
Q 1029	IC				TC4S584F TE85R	G1090974		c1
Q 1030	IC				UPC1037H	G1090101		C7
Q 1031	TRANSISTOR				2SC2712GR TE85R	G3327127G		b4
Q 1032	FET				2SK210GR TE85R	G3802107G		a2
Q 1033	IC				MC14568BCP	G1090347		C7
Q 1034	IC				TDA2003H	G1090815		A3
Q 1035	TRANSISTOR				2SC2714YTE85R	G3327147Y		a1
Q 1036	IC				UPC1037H	G1090101		B6
Q 1037	TRANSISTOR				2SC2712GR TE85R	G3327127G		d5
Q 1038	TRANSISTOR				FA1A4P-T2B	G3070006		a2
Q 1039	TRANSISTOR				2SC2712GR TE85R	G3327127G		b1
Q 1040	TRANSISTOR				2SC2712GR TE85R	G3327127G		c2
Q 1041	IC				TC4S584F TE85R	G1090974		b1
Q 1042	IC				CX-7925B	G1090834		A4
Q 1043	TRANSISTOR				2SC2712GR TE85R	G3327127G		b4
Q 1044	TRANSISTOR				2SC2712GR TE85R	G3327127G		a3
Q 1045	FET				2SK208Y TE85R	G3802087Y		a3
Q 1046	TRANSISTOR				2SC2620QBTR	G3326207B		b3
Q 1047	TRANSISTOR				2SC2712GR TE85R	G3327127G		a3
Q 1048	TRANSISTOR				FA1A4P-T2B	G3070006		a3

REF.	DESCRIPTION	VALUE	WV	TOL.	MFGR'S DESIG	YAESU P/N	VERS.	Addr
Q 1049	IC				M5201L	G1091175		C5
Q 1050	FET				2SK160-T2B K6	G3801607F		c4
Q 1051	TRANSISTOR				2SC2712GR TE85R	G3327127G		d4
Q 1052	TRANSISTOR				FA1A4P-T2B	G3070006		c5
Q 1053	TRANSISTOR				2SA1283D	G3112830D		B3
Q 1054	TRANSISTOR				2SA1283D	G3112830D		B3
Q 1055	TRANSISTOR				FA1A4P-T2B	G3070006		d4
Q 1056	IC				UPC7805H	G1090299		A4
Q 1057	TRANSISTOR				FN1A4P-T2B	G3070011		a3
Q 1058	TRANSISTOR				FN1A4P-T2B	G3070011		a3
Q 1059	TRANSISTOR				FN1A4P-T2B	G3070011		b3
Q 1060	TRANSISTOR				FN1A4P-T2B	G3070011		b3
Q 1061	TRANSISTOR				FA1A4P-T2B	G3070006		b5
Q 1062	TRANSISTOR				FA1A4P-T2B	G3070006		b5
Q 1063	IC				M5218L	G1090649		D4
Q 1064	TRANSISTOR				2SC2712GR TE85R	G3327127G		c2
Q 1065	IC				M5223L	G1090988		A3
Q 1066	IC				M5218L	G1090649		D6
Q 1067	IC				M5218L	G1090649		D6
Q 1068	IC				M5223L	G1090988		B3
Q 1069	TRANSISTOR				2SC2712GR TE85R	G3327127G		c3
Q 1070	TRANSISTOR				2SC2712GR TE85R	G3327127G		c4
Q 1071	TRANSISTOR				2SC2712GR TE85R	G3327127G		d4
Q 1072	TRANSISTOR				2SC2712GR TE85R	G3327127G		c4
Q 1074	TRANSISTOR				FA1A4P-T2B	G3070006		d4
Q 1075	TRANSISTOR				FA1A4P-T2B	G3070006		b4
Q 1076	IC				MC14053BF	G1090703		c5
Q 1077	IC				LC4066BM	G1090772		c5
Q 1078	TRANSISTOR				FA1A4P-T2B	G3070006		c5
Q 1079	TRANSISTOR				FA1A4P-T2B	G3070006		c3
Q 1080	TRANSISTOR				2SC2712GR TE85R	G3327127G		d2
Q 1081	IC				M5218L	G1090649		D6
Q 1082	IC				M5223L	G1090988		D6
Q 1083	TRANSISTOR				FA1A4P-T2B	G3070006		c4
Q 1084	IC				UPC1037H	G1090101		D5
Q 1085	FET				2SK160-T2B K6	G3801607F		d3
Q 1086	TRANSISTOR				FA1A4P-T2B	G3070006		d1
Q 1087	TRANSISTOR				FA1A4P-T2B	G3070006		d2
Q 1088	IC				M5223L	G1090988		B3
Q 1089	TRANSISTOR				2SC2712GR TE85R	G3327127G		d3
Q 1090	TRANSISTOR				FN1A4P-T2B	G3070011		b4
Q 1091	TRANSISTOR				FN1A4P-T2B	G3070011		b4
Q 1092	TRANSISTOR				FN1A4P-T2B	G3070011		b4
Q 1093	TRANSISTOR				FN1A4P-T2B	G3070011		b4
Q 1094	IC				M5223L	G1090988		D5
Q 1095	TRANSISTOR				FA1A4P-T2B	G3070006		d5
Q 1096	TRANSISTOR				FA1A4P-T2B	G3070006		d5
Q 1097	TRANSISTOR				FA1A4P-T2B	G3070006		b4
Q 1098	TRANSISTOR				FA1A4P-T2B	G3070006		b4
Q 1099	TRANSISTOR				FA1A4P-T2B	G3070006		b4
Q 1100	TRANSISTOR				FA1A4P-T2B	G3070006		b4
Q 1101	TRANSISTOR				2SD667C	G3406670C		B4
Q 1102	TRANSISTOR				FN1A4P-T2B	G3070011		d1
Q 1103	TRANSISTOR				FN1A4P-T2B	G3070011		d1
Q 1104	TRANSISTOR				FA1A4P-T2B	G3070006		d1
Q 1105	TRANSISTOR				FA1A4P-T2B	G3070006		d1

Local Unit

REF.	DESCRIPTION	VALUE	WV	TOL.	MFGR'S DESIG	YAESU P/N	VERS.	Addr
Q 1106	TRANSISTOR				FA1A4P-T2B	G3070006		b1
Q 1107	TRANSISTOR				FA1A4P-T2B	G3070006		b4
Q 1108	TRANSISTOR				FA1A4P-T2B	G3070006		d1
Q 1109	TRANSISTOR				FA1A4P-T2B	G3070006		d1
Q 1110	TRANSISTOR				FA1A4P-T2B	G3070006		b5
R 1001	CHIP RES.	0	1/10W		RMC1/10T 000J	J24205000		
R 1002	CHIP RES.	100	1/10W		RMC1/10T 101J	J24205101		
R 1003	CHIP RES.	22K	1/10W		RMC1/10T 223J	J24205223		
R 1004	CHIP RES.	100K	1/10W		RMC1/10T 104J	J24205104		
R 1005	CHIP RES.	22K	1/10W		RMC1/10T 223J	J24205223		
R 1006	CHIP RES.	47	1/10W		RMC1/10T 470J	J24205470		
R 1007	CHIP RES.	2.7K	1/10W		RMC1/10T 272J	J24205272		
R 1008	CHIP RES.	47	1/10W		RMC1/10T 470J	J24205470		
R 1009	CHIP RES.	100	1/10W		RMC1/10T 101J	J24205101		
R 1010	CHIP RES.	100	1/10W		RMC1/10T 101J	J24205101		
R 1011	CHIP RES.	1K	1/10W		RMC1/10T 102J	J24205102		
R 1012	CHIP RES.	22K	1/10W		RMC1/10T 223J	J24205223		
R 1014	CHIP RES.	22K	1/10W		RMC1/10T 223J	J24205223		
R 1015	CHIP RES.	100K	1/10W		RMC1/10T 104J	J24205104		
R 1016	CHIP RES.	1K	1/10W		RMC1/10T 102J	J24205102		
R 1017	CHIP RES.	3.3K	1/10W		RMC1/10T 332J	J24205332		
R 1018	CHIP RES.	330	1/10W		RMC1/10T 331J	J24205331		
R 1019	CHIP RES.	100	1/10W		RMC1/10T 101J	J24205101		
R 1020	CHIP RES.	2.2K	1/10W		RMC1/10T 222J	J24205222		
R 1021	CHIP RES.	0	1/10W		RMC1/10T 000J	J24205000		
R 1022	CHIP RES.	15K	1/10W		RMC1/10T 153J	J24205153		
R 1023	CHIP RES.	0	1/10W		RMC1/10T 000J	J24205000		
R 1024	CHIP RES.	0	1/10W		RMC1/10T 000J	J24205000		
R 1025	CHIP RES.	15K	1/10W		RMC1/10T 153J	J24205153		
R 1027	CHIP RES.	470	1/10W		RMC1/10T 471J	J24205471		
R 1029	CHIP RES.	1K	1/10W		RMC1/10T 102J	J24205102		
R 1030	CHIP RES.	15K	1/10W		RMC1/10T 153J	J24205153		
R 1031	CHIP RES.	100	1/10W		RMC1/10T 101J	J24205101		
R 1032	CHIP RES.	150	1/10W		RMC1/10T 151J	J24205151		
R 1033	CHIP RES.	100K	1/10W		RMC1/10T 104J	J24205104		
R 1034	CHIP RES.	4.7K	1/10W		RMC1/10T 472J	J24205472		
R 1035	CHIP RES.	0	1/10W		RMC1/10T 000J	J24205000		
R 1036	CHIP RES.	470	1/10W		RMC1/10T 471J	J24205471		
R 1037	CHIP RES.	100	1/10W		RMC1/10T 101J	J24205101		
R 1039	CHIP RES.	47	1/10W		RMC1/10T 470J	J24205470		
R 1040	CHIP RES.	470	1/10W		RMC1/10T 471J	J24205471		
R 1041	CHIP RES.	100K	1/10W		RMC1/10T 104J	J24205104		
R 1042	CHIP RES.	680	1/10W		RMC1/10T 681J	J24205681		
R 1043	CHIP RES.	0	1/10W		RMC1/10T 000J	J24205000		
R 1044	CHIP RES.	22K	1/10W		RMC1/10T 223J	J24205223		
R 1046	CHIP RES.	22K	1/10W		RMC1/10T 223J	J24205223		
R 1047	CHIP RES.	680	1/10W		RMC1/10T 681J	J24205681		
R 1049	CHIP RES.	100K	1/10W		RMC1/10T 104J	J24205104		
R 1050	CHIP RES.	1K	1/10W		RMC1/10T 102J	J24205102		
R 1051	CHIP RES.	15K	1/10W		RMC1/10T 153J	J24205153		
R 1052	CHIP RES.	150	1/10W		RMC1/10T 151J	J24205151		
R 1053	CHIP RES.	150	1/10W		RMC1/10T 151J	J24205151		
R 1054	CHIP RES.	560	1/10W		RMC1/10T 561J	J24205561		
R 1055	CHIP RES.	680	1/10W		RMC1/10T 681J	J24205681		
R 1056	CHIP RES.	100K	1/10W		RMC1/10T 104J	J24205104		

Local Unit

REF.	DESCRIPTION	VALUE	WV	TOL.	MFGR'S DESIG	YAESU P/N	VERS.	Addr
R 1057	CHIP RES.	1K	1/10W		RMC1/10T 102J	J24205102		
R 1058	CHIP RES.	680	1/10W		RMC1/10T 681J	J24205681		
R 1059	CHIP RES.	100K	1/10W		RMC1/10T 104J	J24205104		
R 1060	CHIP RES.	680	1/10W		RMC1/10T 681J	J24205681		
R 1061	CHIP RES.	1K	1/10W		RMC1/10T 102J	J24205102		
R 1062	CHIP RES.	10K	1/10W		RMC1/10T 103J	J24205103		
R 1063	CHIP RES.	100	1/10W		RMC1/10T 101J	J24205101		
R 1064	CHIP RES.	680	1/10W		RMC1/10T 681J	J24205681		
R 1065	CHIP RES.	100K	1/10W		RMC1/10T 104J	J24205104		
R 1066	CHIP RES.	100K	1/10W		RMC1/10T 104J	J24205104		
R 1067	CHIP RES.	68	1/10W		RMC1/10T 680J	J24205680		
R 1068	CHIP RES.	470	1/10W		RMC1/10T 471J	J24205471		
R 1069	CHIP RES.	220	1/10W		RMC1/10T 221J	J24205221		
R 1070	CHIP RES.	100	1/10W		RMC1/10T 101J	J24205101		
R 1071	CHIP RES.	1K	1/10W		RMC1/10T 102J	J24205102		
R 1072	CHIP RES.	22K	1/10W		RMC1/10T 223J	J24205223		
R 1074	CHIP RES.	100	1/10W		RMC1/10T 101J	J24205101		
R 1075	CHIP RES.	22K	1/10W		RMC1/10T 223J	J24205223		
R 1076	CHIP RES.	150	1/10W		RMC1/10T 151J	J24205151		
R 1077	CHIP RES.	100	1/10W		RMC1/10T 101J	J24205101		
R 1078	CHIP RES.	100K	1/10W		RMC1/10T 104J	J24205104		
R 1079	CHIP RES.	47	1/10W		RMC1/10T 470J	J24205470		
R 1080	CHIP RES.	220	1/10W		RMC1/10T 221J	J24205221		
R 1081	CHIP RES.	100	1/10W		RMC1/10T 101J	J24205101		
R 1082	CHIP RES.	47	1/10W		RMC1/10T 470J	J24205470		
R 1083	CHIP RES.	150	1/10W		RMC1/10T 151J	J24205151		
R 1085	CHIP RES.	2. 2K	1/10W		RMC1/10T 222J	J24205222		
R 1086	CHIP RES.	4. 7K	1/10W		RMC1/10T 472J	J24205472		
R 1087	CHIP RES.	560	1/10W		RMC1/10T 561J	J24205561		
R 1088	CHIP RES.	10K	1/10W		RMC1/10T 103J	J24205103		
R 1089	CHIP RES.	15K	1/10W		RMC1/10T 153J	J24205153		
R 1090	CHIP RES.	220	1/10W		RMC1/10T 221J	J24205221		
R 1091	CHIP RES.	47	1/10W		RMC1/10T 470J	J24205470		
R 1092	CHIP RES.	820	1/10W		RMC1/10T 821J	J24205821		
R 1093	CHIP RES.	100K	1/10W		RMC1/10T 104J	J24205104		
R 1094	CHIP RES.	150	1/10W		RMC1/10T 151J	J24205151		
R 1095	CHIP RES.	1K	1/10W		RMC1/10T 102J	J24205102		
R 1096	CHIP RES.	22K	1/10W		RMC1/10T 223J	J24205223		
R 1098	CHIP RES.	10K	1/10W		RMC1/10T 103J	J24205103		
R 1099	CHIP RES.	1. 5K	1/10W		RMC1/10T 152J	J24205152		
R 1100	CHIP RES.	68	1/10W		RMC1/10T 680J	J24205680		
R 1101	CHIP RES.	3. 3K	1/10W		RMC1/10T 332J	J24205332		
R 1102	CHIP RES.	3. 3K	1/10W		RMC1/10T 332J	J24205332		
R 1103	CHIP RES.	100	1/10W		RMC1/10T 101J	J24205101		
R 1104	CHIP RES.	100	1/10W		RMC1/10T 101J	J24205101		
R 1105	CHIP RES.	150	1/10W		RMC1/10T 151J	J24205151		
R 1106	CHIP RES.	68	1/10W		RMC1/10T 680J	J24205680		
R 1107	CHIP RES.	15K	1/10W		RMC1/10T 153J	J24205153		
R 1108	CHIP RES.	100	1/10W		RMC1/10T 101J	J24205101		
R 1109	CHIP RES.	150	1/10W		RMC1/10T 151J	J24205151		
R 1110	CHIP RES.	150	1/10W		RMC1/10T 151J	J24205151		
R 1111	CARBON FILM RES.	1	1/6W		RD16TPJ010	J07225010		
R 1112	CHIP RES.	100K	1/10W		RMC1/10T 104J	J24205104		
R 1113	CARBON FILM RES.	270	1/6W		RD16TPJ271	J07225271		
R 1114	CHIP RES.	100K	1/10W		RMC1/10T 104J	J24205104		
R 1115	CHIP RES.	820	1/10W		RMC1/10T 821J	J24205821		

Local Unit

REF.	DESCRIPTION	VALUE	WV	TOL.	MFGR'S DESIG	YAESU P/N	VERS.	Addr
R 1116	CHIP RES.	1K	1/10W		RMC1/10T 102J	J24205102		
R 1117	CHIP RES.	100K	1/10W		RMC1/10T 104J	J24205104		
R 1118	CHIP RES.	100K	1/10W		RMC1/10T 104J	J24205104		
R 1119	CHIP RES.	100	1/10W		RMC1/10T 101J	J24205101		
R 1120	CARBON FILM RES.	2. 2	1/6W		RD16TPJ2R2	J07225229		
R 1122	CHIP RES.	330	1/10W		RMC1/10T 331J	J24205331		
R 1123	CHIP RES.	68	1/10W		RMC1/10T 680J	J24205680		
R 1124	CHIP RES.	560	1/10W		RMC1/10T 561J	J24205561		
R 1125	CHIP RES.	1K	1/10W		RMC1/10T 102J	J24205102		
R 1126	CHIP RES.	680	1/10W		RMC1/10T 681J	J24205681		
R 1127	CHIP RES.	150	1/10W		RMC1/10T 151J	J24205151		
R 1128	CHIP RES.	100	1/10W		RMC1/10T 101J	J24205101		
R 1129	CHIP RES.	470	1/10W		RMC1/10T 471J	J24205471		
R 1130	CHIP RES.	1. 5K	1/10W		RMC1/10T 152J	J24205152		
R 1131	CHIP RES.	680	1/10W		RMC1/10T 681J	J24205681		
R 1132	CHIP RES.	100K	1/10W		RMC1/10T 104J	J24205104		
R 1133	CHIP RES.	100K	1/10W		RMC1/10T 104J	J24205104		
R 1134	CHIP RES.	0	1/10W		RMC1/10T 000J	J24205000		
R 1135	CHIP RES.	1K	1/10W		RMC1/10T 102J	J24205102		
R 1136	CHIP RES.	680	1/10W		RMC1/10T 681J	J24205681		
R 1137	CHIP RES.	100	1/10W		RMC1/10T 101J	J24205101		
R 1138	CHIP RES.	4. 7K	1/10W		RMC1/10T 472J	J24205472		
R 1139	CHIP RES.	2. 2K	1/10W		RMC1/10T 222J	J24205222		
R 1140	CHIP RES.	330	1/10W		RMC1/10T 331J	J24205331		
R 1141	CHIP RES.	1K	1/10W		RMC1/10T 102J	J24205102		
R 1142	CHIP RES.	2. 2K	1/10W		RMC1/10T 222J	J24205222		
R 1143	CHIP RES.	68	1/10W		RMC1/10T 680J	J24205680		
R 1144	CHIP RES.	680	1/10W		RMC1/10T 681J	J24205681		
R 1145	CHIP RES.	220	1/10W		RMC1/10T 221J	J24205221		
R 1146	CHIP RES.	150	1/10W		RMC1/10T 151J	J24205151		
R 1148	CHIP RES.	680	1/10W		RMC1/10T 681J	J24205681		
R 1149	CHIP RES.	2. 2K	1/10W		RMC1/10T 222J	J24205222		
R 1150	CHIP RES.	68K	1/10W		RMC1/10T 683J	J24205683		
R 1151	CHIP RES.	3. 3K	1/10W		RMC1/10T 332J	J24205332		
R 1153	CHIP RES.	4. 7K	1/10W		RMC1/10T 472J	J24205472		
R 1154	CHIP RES.	4. 7K	1/10W		RMC1/10T 472J	J24205472		
R 1155	CHIP RES.	2. 2K	1/10W		RMC1/10T 222J	J24205222		
R 1156	CHIP RES.	680	1/10W		RMC1/10T 681J	J24205681		
R 1157	CHIP RES.	3. 3K	1/10W		RMC1/10T 332J	J24205332		
R 1158	CHIP RES.	33K	1/10W		RMC1/10T 333J	J24205333		
R 1159	CHIP RES.	330	1/10W		RMC1/10T 331J	J24205331		
R 1160	CHIP RES.	1K	1/10W		RMC1/10T 102J	J24205102		
R 1161	CHIP RES.	1K	1/10W		RMC1/10T 102J	J24205102		
R 1162	CHIP RES.	1K	1/10W		RMC1/10T 102J	J24205102		
R 1163	CHIP RES.	10K	1/10W		RMC1/10T 103J	J24205103		
R 1164	CHIP RES.	150K	1/10W		RMC1/10T 154J	J24205154		
R 1165	CHIP RES.	470	1/10W		RMC1/10T 471J	J24205471		
R 1166	CHIP RES.	100K	1/10W		RMC1/10T 104J	J24205104		
R 1167	CHIP RES.	22K	1/10W		RMC1/10T 223J	J24205223		
R 1168	CHIP RES.	15K	1/10W		RMC1/10T 153J	J24205153		
R 1169	CHIP RES.	47	1/10W		RMC1/10T 470J	J24205470		
R 1170	CHIP RES.	4. 7K	1/10W		RMC1/10T 472J	J24205472		
R 1171	CHIP RES.	47K	1/10W		RMC1/10T 473J	J24205473		
R 1172	CHIP RES.	10K	1/10W		RMC1/10T 103J	J24205103		
R 1173	CHIP RES.	100	1/10W		RMC1/10T 101J	J24205101		
R 1174	CHIP RES.	47K	1/10W		RMC1/10T 473J	J24205473		

REF.	DESCRIPTION	VALUE	WV	TOL.	MFGR'S DESIG	YAESU P/N	VERS.	Addr
R 1175	CHIP RES.	1K	1/10W		RMC1/10T 102J	J24205102		
R 1176	CHIP RES.	1K	1/10W		RMC1/10T 102J	J24205102		
R 1177	CHIP RES.	10K	1/10W		RMC1/10T 103J	J24205103		
R 1178	CHIP RES.	47	1/10W		RMC1/10T 470J	J24205470		
R 1179	CHIP RES.	470	1/10W		RMC1/10T 471J	J24205471		
R 1180	CHIP RES.	15K	1/10W		RMC1/10T 153J	J24205153		
R 1181	CHIP RES.	10K	1/10W		RMC1/10T 103J	J24205103		
R 1182	CHIP RES.	1K	1/10W		RMC1/10T 102J	J24205102		
R 1183	CHIP RES.	1K	1/10W		RMC1/10T 102J	J24205102		
R 1184	CHIP RES.	1K	1/10W		RMC1/10T 102J	J24205102		
R 1185	CHIP RES.	100K	1/10W		RMC1/10T 104J	J24205104		
R 1186	CHIP RES.	2. 2M	1/10W		RMC1/10T 225J	J24205225		
R 1187	CHIP RES.	47K	1/10W		RMC1/10T 473J	J24205473		
R 1188	CHIP RES.	100K	1/10W		RMC1/10T 104J	J24205104		
R 1189	CHIP RES.	10	1/10W		RMC1/10T 100J	J24205100		
R 1190	CHIP RES.	560K	1/10W		RMC1/10T 564J	J24205564		
R 1191	CHIP RES.	100K	1/10W		RMC1/10T 104J	J24205104		
R 1192	CHIP RES.	3. 3M	1/10W		RMC1/10T 335J	J24205335		
R 1193	CHIP RES.	6. 8K	1/10W		RMC1/10T 682J	J24205682		
R 1194	CHIP RES.	100K	1/10W		RMC1/10T 104J	J24205104		
R 1195	CHIP RES.	150K	1/10W		RMC1/10T 154J	J24205154		
R 1196	CHIP RES.	47K	1/10W		RMC1/10T 473J	J24205473		
R 1197	CHIP RES.	2. 2K	1/10W		RMC1/10T 222J	J24205222		
R 1198	CHIP RES.	10K	1/10W		RMC1/10T 103J	J24205103		
R 1199	CHIP RES.	10K	1/10W		RMC1/10T 103J	J24205103		
R 1200	CHIP RES.	47K	1/10W		RMC1/10T 473J	J24205473		
R 1201	CHIP RES.	2. 2K	1/10W		RMC1/10T 222J	J24205222		
R 1202	CHIP RES.	2. 2K	1/10W		RMC1/10T 222J	J24205222		
R 1203	CHIP RES.	33K	1/10W		RMC1/10T 333J	J24205333		
R 1204	CHIP RES.	150K	1/10W		RMC1/10T 154J	J24205154		
R 1205	CHIP RES.	100K	1/10W		RMC1/10T 104J	J24205104		
R 1206	CHIP RES.	47K	1/10W		RMC1/10T 473J	J24205473		
R 1207	CHIP RES.	100K	1/10W		RMC1/10T 104J	J24205104		
R 1208	CHIP RES.	10K	1/10W		RMC1/10T 103J	J24205103		
R 1209	CHIP RES.	1K	1/10W		RMC1/10T 102J	J24205102		
R 1210	CHIP RES.	10K	1/10W		RMC1/10T 103J	J24205103		
R 1211	CHIP RES.	10K	1/10W		RMC1/10T 103J	J24205103		
R 1213	CHIP RES.	470K	1/10W		RMC1/10T 474J	J24205474		
R 1214	CHIP RES.	100K	1/10W		RMC1/10T 104J	J24205104		
R 1215	CHIP RES.	33K	1/10W		RMC1/10T 333J	J24205333		
R 1216	CHIP RES.	2. 2K	1/10W		RMC1/10T 222J	J24205222		
R 1217	CHIP RES.	100	1/10W		RMC1/10T 101J	J24205101		
R 1218	CHIP RES.	100	1/10W		RMC1/10T 101J	J24205101		
R 1219	CHIP RES.	330K	1/10W		RMC1/10T 334J	J24205334		
R 1220	CHIP RES.	3. 3K	1/10W		RMC1/10T 332J	J24205332		
R 1221	CHIP RES.	68K	1/10W		RMC1/10T 683J	J24205683		
R 1222	CHIP RES.	1K	1/10W		RMC1/10T 102J	J24205102		
R 1223	CHIP RES.	10K	1/10W		RMC1/10T 103J	J24205103		
R 1224	CHIP RES.	3. 3K	1/10W		RMC1/10T 332J	J24205332		
R 1225	CHIP RES.	2. 2K	1/10W		RMC1/10T 222J	J24205222		
R 1226	CHIP RES.	10K	1/10W		RMC1/10T 103J	J24205103		
R 1227	CHIP RES.	100K	1/10W		RMC1/10T 104J	J24205104		
R 1228	CHIP RES.	2. 2K	1/10W		RMC1/10T 222J	J24205222		
R 1229	CHIP RES.	100K	1/10W		RMC1/10T 104J	J24205104		
R 1230	CHIP RES.	150K	1/10W		RMC1/10T 154J	J24205154		
R 1231	CHIP RES.	470K	1/10W		RMC1/10T 474J	J24205474		

Local Unit

REF.	DESCRIPTION	VALUE	WV	TOL.	MFGR'S DESIG	YAESU P/N	VERS.	Addr
R 1232	CHIP RES.	47K	1/10W		RMC1/10T 473J	J24205473		
R 1233	CHIP RES.	100K	1/10W		RMC1/10T 104J	J24205104		
R 1234	CHIP RES.	100K	1/10W		RMC1/10T 104J	J24205104		
R 1235	CHIP RES.	18K	1/10W		RMC1/10T 183J	J24205183		
R 1236	CHIP RES.	10K	1/10W		RMC1/10T 103J	J24205103		
R 1237	CHIP RES.	1K	1/10W		RMC1/10T 102J	J24205102		
R 1238	CHIP RES.	4. 7K	1/10W		RMC1/10T 472J	J24205472		
R 1239	CHIP RES.	10K	1/10W		RMC1/10T 103J	J24205103		
R 1240	CHIP RES.	33K	1/10W		RMC1/10T 333J	J24205333		
R 1241	CHIP RES.	150K	1/10W		RMC1/10T 154J	J24205154		
R 1242	CHIP RES.	100K	1/10W		RMC1/10T 104J	J24205104		
R 1243	CHIP RES.	100K	1/10W		RMC1/10T 104J	J24205104		
R 1244	CHIP RES.	4. 7K	1/10W		RMC1/10T 472J	J24205472		
R 1245	CHIP RES.	10K	1/10W		RMC1/10T 103J	J24205103		
R 1247	CHIP RES.	10K	1/10W		RMC1/10T 103J	J24205103		
R 1248	CHIP RES.	330	1/10W		RMC1/10T 331J	J24205331		
R 1249	CHIP RES.	1K	1/10W		RMC1/10T 102J	J24205102		
R 1250	CHIP RES.	10K	1/10W		RMC1/10T 103J	J24205103		
R 1251	CHIP RES.	150K	1/10W		RMC1/10T 154J	J24205154		
R 1252	CHIP RES.	82	1/10W		RMC1/10T 820J	J24205820		
R 1253	CHIP RES.	33K	1/10W		RMC1/10T 333J	J24205333		
R 1254	CHIP RES.	3. 9K	1/10W		RMC1/10T 392J	J24205392		
R 1255	CHIP RES.	10K	1/10W		RMC1/10T 103J	J24205103		
R 1256	CHIP RES.	1M	1/10W		RMC1/10T 105J	J24205105		
R 1257	CHIP RES.	100K	1/10W		RMC1/10T 104J	J24205104		
R 1258	CHIP RES.	220	1/10W		RMC1/10T 221J	J24205221		
R 1259	CHIP RES.	180	1/10W		RMC1/10T 181J	J24205181		
R 1260	CHIP RES.	22K	1/10W		RMC1/10T 223J	J24205223		
R 1261	CHIP RES.	470	1/10W		RMC1/10T 471J	J24205471		
R 1262	CHIP RES.	10K	1/10W		RMC1/10T 103J	J24205103		
R 1263	CHIP RES.	220K	1/10W		RMC1/10T 224J	J24205224		
R 1264	CHIP RES.	100K	1/10W		RMC1/10T 104J	J24205104		
R 1265	CHIP RES.	47K	1/10W		RMC1/10T 473J	J24205473		
R 1266	CHIP RES.	10	1/10W		RMC1/10T 100J	J24205100		
R 1267	CHIP RES.	100K	1/10W		RMC1/10T 104J	J24205104		
R 1268	CHIP RES.	1K	1/10W		RMC1/10T 102J	J24205102		
R 1269	CHIP RES.	10K	1/10W		RMC1/10T 103J	J24205103		
R 1270	CHIP RES.	100K	1/10W		RMC1/10T 104J	J24205104		
R 1271	CHIP RES.	220K	1/10W		RMC1/10T 224J	J24205224		
R 1272	CHIP RES.	100K	1/10W		RMC1/10T 104J	J24205104		
R 1273	CHIP RES.	47K	1/10W		RMC1/10T 473J	J24205473		
R 1274	CHIP RES.	10K	1/10W		RMC1/10T 103J	J24205103		
R 1275	CHIP RES.	100K	1/10W		RMC1/10T 104J	J24205104		
R 1276	CHIP RES.	100K	1/10W		RMC1/10T 104J	J24205104		
R 1277	CHIP RES.	22K	1/10W		RMC1/10T 223J	J24205223		
R 1278	CHIP RES.	100K	1/10W		RMC1/10T 104J	J24205104		
R 1279	CHIP RES.	4. 7K	1/10W		RMC1/10T 472J	J24205472		
R 1280	CHIP RES.	100K	1/10W		RMC1/10T 104J	J24205104		
R 1281	CHIP RES.	1. 5K	1/10W		RMC1/10T 152J	J24205152		
R 1282	CHIP RES.	4. 7K	1/10W		RMC1/10T 472J	J24205472		
R 1283	CHIP RES.	1K	1/10W		RMC1/10T 102J	J24205102		
R 1284	CHIP RES.	1. 5K	1/10W		RMC1/10T 152J	J24205152		
R 1285	CHIP RES.	220K	1/10W		RMC1/10T 224J	J24205224		
R 1286	CHIP RES.	47K	1/10W		RMC1/10T 473J	J24205473		
R 1287	CHIP RES.	2. 2M	1/10W		RMC1/10T 225J	J24205225		
R 1288	CHIP RES.	100K	1/10W		RMC1/10T 104J	J24205104		

Local Unit

REF.	DESCRIPTION	VALUE	WV	TOL.	MFGR'S DESIG	YAESU P/N	VERS.	Addr
R 1289	CHIP RES.	1K	1/10W		RMC1/10T 102J	J24205102		
R 1290	CHIP RES.	100K	1/10W		RMC1/10T 104J	J24205104		
R 1291	CHIP RES.	2. 2K	1/10W		RMC1/10T 222J	J24205222		
R 1292	CHIP RES.	10K	1/10W		RMC1/10T 103J	J24205103		
R 1293	CHIP RES.	100K	1/10W		RMC1/10T 104J	J24205104		
R 1294	CHIP RES.	2. 2M	1/10W		RMC1/10T 225J	J24205225		
R 1295	CHIP RES.	2. 2K	1/10W		RMC1/10T 222J	J24205222		
R 1296	CHIP RES.	47K	1/10W		RMC1/10T 473J	J24205473		
R 1297	CHIP RES.	4. 7K	1/10W		RMC1/10T 472J	J24205472		
R 1298	CHIP RES.	15K	1/10W		RMC1/10T 153J	J24205153		
R 1299	CHIP RES.	12K	1/10W		RMC1/10T 123J	J24205123		
R 1300	CHIP RES.	12K	1/10W		RMC1/10T 123J	J24205123		
R 1301	CHIP RES.	10K	1/10W		RMC1/10T 103J	J24205103		
R 1302	CHIP RES.	22K	1/10W		RMC1/10T 223J	J24205223		
R 1303	CHIP RES.	4. 7K	1/10W		RMC1/10T 472J	J24205472		
R 1304	CHIP RES.	1K	1/10W		RMC1/10T 102J	J24205102		
R 1305	CHIP RES.	100	1/10W		RMC1/10T 101J	J24205101		
R 1306	CHIP RES.	150	1/10W		RMC1/10T 151J	J24205151		
R 1307	CHIP RES.	1M	1/10W		RMC1/10T 105J	J24205105		
R 1308	CHIP RES.	2. 2K	1/10W		RMC1/10T 222J	J24205222		
R 1309	CHIP RES.	68	1/10W		RMC1/10T 680J	J24205680		
R 1310	CHIP RES.	1K	1/10W		RMC1/10T 102J	J24205102		
R 1311	CHIP RES.	68K	1/10W		RMC1/10T 683J	J24205683		
R 1312	CHIP RES.	3. 3M	1/10W		RMC1/10T 335J	J24205335		
R 1313	CHIP RES.	100K	1/10W		RMC1/10T 104J	J24205104		
R 1314	CHIP RES.	10K	1/10W		RMC1/10T 103J	J24205103		
R 1315	CHIP RES.	10K	1/10W		RMC1/10T 103J	J24205103		
R 1316	CHIP RES.	4. 7K	1/10W		RMC1/10T 472J	J24205472		
R 1317	CHIP RES.	4. 7K	1/10W		RMC1/10T 472J	J24205472		
R 1318	CHIP RES.	12K	1/10W		RMC1/10T 123J	J24205123		
R 1319	CHIP RES.	12K	1/10W		RMC1/10T 123J	J24205123		
R 1320	CHIP RES.	2. 2K	1/10W		RMC1/10T 222J	J24205222		
R 1321	CHIP RES.	1M	1/10W		RMC1/10T 105J	J24205105		
R 1322	CHIP RES.	10K	1/10W		RMC1/10T 103J	J24205103		
R 1325	CHIP RES.	3. 3K	1/10W		RMC1/10T 332J	J24205332		
R 1327	CHIP RES.	0	1/10W		RMC1/10T 000J	J24205000		
R 1328	CHIP RES.	220	1/10W		RMC1/10T 221J	J24205221		
R 1329	CHIP RES.	220	1/10W		RMC1/10T 221J	J24205221		
R 1330	CHIP RES.	220	1/10W		RMC1/10T 221J	J24205221		
R 1331	CHIP RES.	220	1/10W		RMC1/10T 221J	J24205221		
R 1332	CHIP RES.	220	1/10W		RMC1/10T 221J	J24205221		
R 1333	CHIP RES.	220	1/10W		RMC1/10T 221J	J24205221		
R 1334	CHIP RES.	0	1/10W		RMC1/10T 000J	J24205000		
R 1335	CHIP RES.	220	1/10W		RMC1/10T 221J	J24205221		
R 1336	CHIP RES.	220	1/10W		RMC1/10T 221J	J24205221		
R 1337	CHIP RES.	220	1/10W		RMC1/10T 221J	J24205221		
R 1338	CHIP RES.	33K	1/10W		RMC1/10T 333J	J24205333		
R 1339	CHIP RES.	4. 7K	1/10W		RMC1/10T 472J	J24205472		
R 1340	CHIP RES.	3. 3K	1/10W		RMC1/10T 332J	J24205332		
R 1341	CHIP RES.	100K	1/10W		RMC1/10T 104J	J24205104		
R 1342	CHIP RES.	100	1/10W		RMC1/10T 101J	J24205101		
R 1343	CHIP RES.	56K	1/10W		RMC1/10T 563J	J24205563		
R 1344	CHIP RES.	10K	1/10W		RMC1/10T 103J	J24205103		
R 1345	CHIP RES.	150K	1/10W		RMC1/10T 154J	J24205154		
R 1346	CHIP RES.	15K	1/10W		RMC1/10T 153J	J24205153		
R 1347	CHIP RES.	22K	1/10W		RMC1/10T 223J	J24205223		

Local Unit

REF.	DESCRIPTION	VALUE	WV	TOL.	MFGR'S DESIG	YAESU P/N	VERS.	Addr
R 1348	CHIP RES.	15K	1/10W		RMC1/10T 153J	J24205153		
R 1349	CHIP RES.	5.6K	1/10W		RMC1/10T 562J	J24205562		
R 1350	CHIP RES.	100	1/10W		RMC1/10T 101J	J24205101		
R 1351	CHIP RES.	100K	1/10W		RMC1/10T 104J	J24205104		
R 1352	CHIP RES.	470	1/10W		RMC1/10T 471J	J24205471		
R 1353	CHIP RES.	47K	1/10W		RMC1/10T 473J	J24205473		
R 1354	CHIP RES.	1K	1/10W		RMC1/10T 102J	J24205102		
R 1355	CHIP RES.	47K	1/10W		RMC1/10T 473J	J24205473		
R 1357	CHIP RES.	1K	1/10W		RMC1/10T 102J	J24205102		
R 1358	CHIP RES.	68K	1/10W		RMC1/10T 683J	J24205683		
R 1359	CHIP RES.	68K	1/10W		RMC1/10T 683J	J24205683		
R 1360	CHIP RES.	10K	1/10W		RMC1/10T 103J	J24205103		
R 1361	CARBON FILM RES.	1	1/6W		RD16TPJ010	J07225010		
R 1362	CHIP RES.	330	1/10W		RMC1/10T 331J	J24205331		
R 1363	CHIP RES.	22K	1/10W		RMC1/10T 223J	J24205223		
R 1364	CHIP RES.	100K	1/10W		RMC1/10T 104J	J24205104		
R 1365	CHIP RES.	47K	1/10W		RMC1/10T 473J	J24205473		
R 1366	CHIP RES.	100K	1/10W		RMC1/10T 104J	J24205104		
R 1367	CHIP RES.	15K	1/10W		RMC1/10T 153J	J24205153		
R 1368	CHIP RES.	2.2K	1/10W		RMC1/10T 222J	J24205222		
R 1369	CHIP RES.	1K	1/10W		RMC1/10T 102J	J24205102		
R 1370	CHIP RES.	100K	1/10W		RMC1/10T 104J	J24205104		
R 1372	CHIP RES.	3.9K	1/10W		RMC1/10T 392J	J24205392		
R 1373	CHIP RES.	2.2K	1/10W		RMC1/10T 222J	J24205222		
R 1374	CARBON FILM RES.	12K	1/6W		RD16TPJ123	J07225123	PWR 10	
R 1374	CARBON FILM RES.	12K	1/6W		RD16TPJ123	J07225123	PWR 25	
R 1375	CHIP RES.	6.8K	1/10W		RMC1/10T 682J	J24205682		
R 1376	METAL FILM RES.	3.3	1W		RS1B 1W K 3.3	J20306339		
S 1001	SLIDE SWITCH				SSS212299	N6090051		
T 1002	COIL				61.44M R12-H956A	L0021932		
T 1003	COIL				61.44M R12-H956A	L0021932		
T 1004	COIL				4-1 2D3 TR6X3	L0020788A		
T 1005	COIL				61.44M R12-H956A	L0021932		
T 1006	COIL				61.44M R12-H956A	L0021932		
TC1001	TRIMMER CAP.	6pF			ECV1ZW06X53T	K91000055		
TC1002	TRIMMER CAP.	20p			VCT51E117	K91000086		
TC1003	TRIMMER CAP.	6pF			ECV1ZW06X53T	K91000055		
TC1004	TRIMMER CAP.	6pF			ECV1ZW06X53T	K91000055		
TC1005	TRIMMER CAP.	6pF			ECV1ZW06X53T	K91000055		
TP1001	TP-E/				TP-E/MS-60124	Q5000016		
TP1002	TP-E/				TP-E/MS-60124	Q5000016		
TP1003	TP-E/				TP-E/MS-60124	Q5000016		
TP1004	TP-E/				TP-E/MS-60124	Q5000016		
TP1005	TP-E/				TP-E/MS-60124	Q5000016		
TP1006	TP-E/				TP-E/MS-60124	Q5000016		
TP1007	TP-E/				TP-E/MS-60124	Q5000016		
TP1008	TP-E/				TP-E/MS-60124	Q5000016		
TP1009	TP-E/				TP-E/MS-60124	Q5000016		
VR1001	POT.	1KB			H0652A007-1KB	J50770102		
VR1002	POT.	1MB			H0652A025-1MB	J50770105		
VR1003	POT.	10KB			K091B0Z09-10KB	J60800124		

Local Unit

REF.	DESCRIPTION	VALUE	WV	TOL.	MFGR'S DESIG	YAESU P/N	VERS.	Addr
VR1004	POT.	10KB			H0652A013-10KB	J50770103		
VR1006	POT.	500KB			K091B0Z09-500KB	J60800126		
VR1007	POT.	10KB			K091B0Z09-10KB	J60800124		
VR1008	POT.	10KB			H0652A013-10KB	J50770103		
VR1010	POT.	1KB			H0652A007-1KB	J50770102		
VR1011	POT.	4.7KB			H0652A011-4.7KB	J50770472		
VR1012	POT.	10KB			H0652A013-10KB	J50770103		
VR1013	POT.	1KB			H0652A007-1KB	J50770102		
VR1014	POT.	10KB			H0652A013-10KB	J50770103		
VR1015	POT.	10KB			H0652A013-10KB	J50770103		
VR1017	POT.	10KB			H0652A013-10KB	J50770103		
VR1018	POT.	10KB			H0652A013-10KB	J50770103		
VR1019	POT.	10KB			K091B0Z09-10KB	J60800124		
VR1020	POT.	10KB			H0652A013-10KB	J50770103		
VR1022	POT.	10KB			H0652A013-10KB	J50770103		
X 1001	XTAL	10.48576MHz			HC-49/U	H0102990		
X 1002	XTAL	70.000MHz			HC-49/T	H0103009		

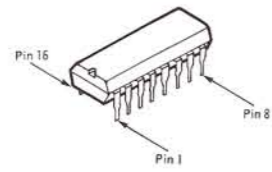

SN74LS145N
(Q2062)

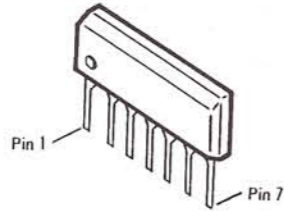

μPC1037H
(Q2020)

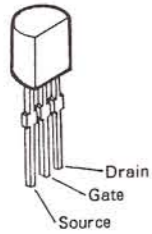

2SK125
(Q2005, 2006, 2007,
2008, 2009, 2010)

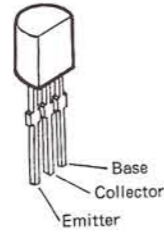

2SC1973
(Q2051)
2SC2026
(Q2053)

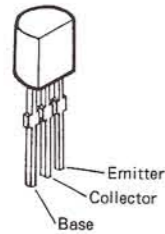

2SC2053
(Q2011)

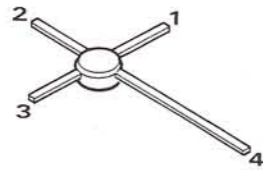

ND487C2-3R
(D2078)

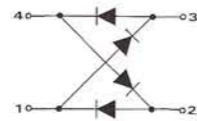

ND487C2-3R CIRCUIT DIAGRAM

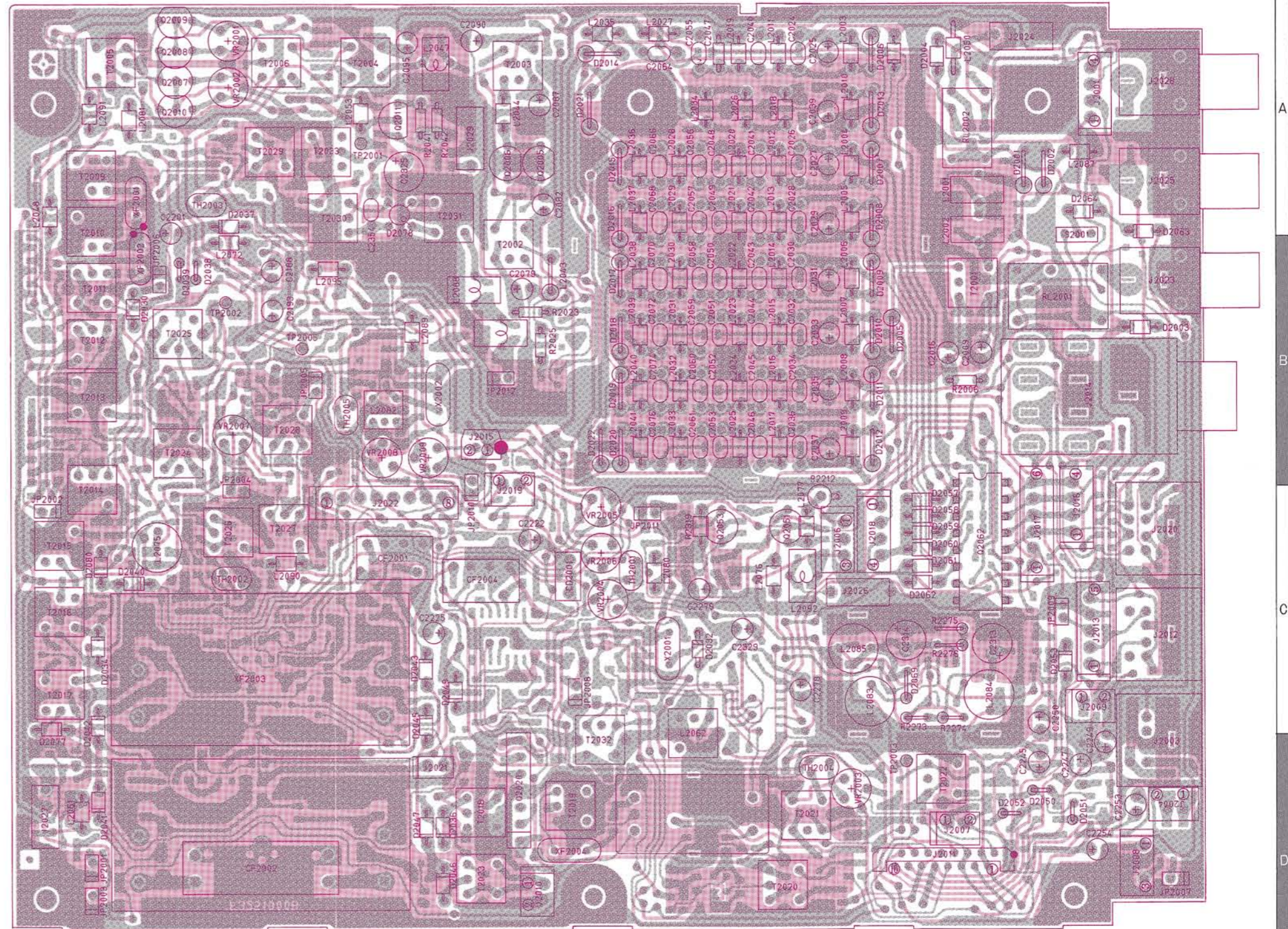

"component" side

RF Unit

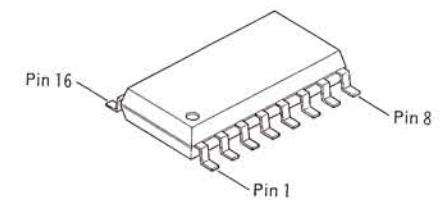
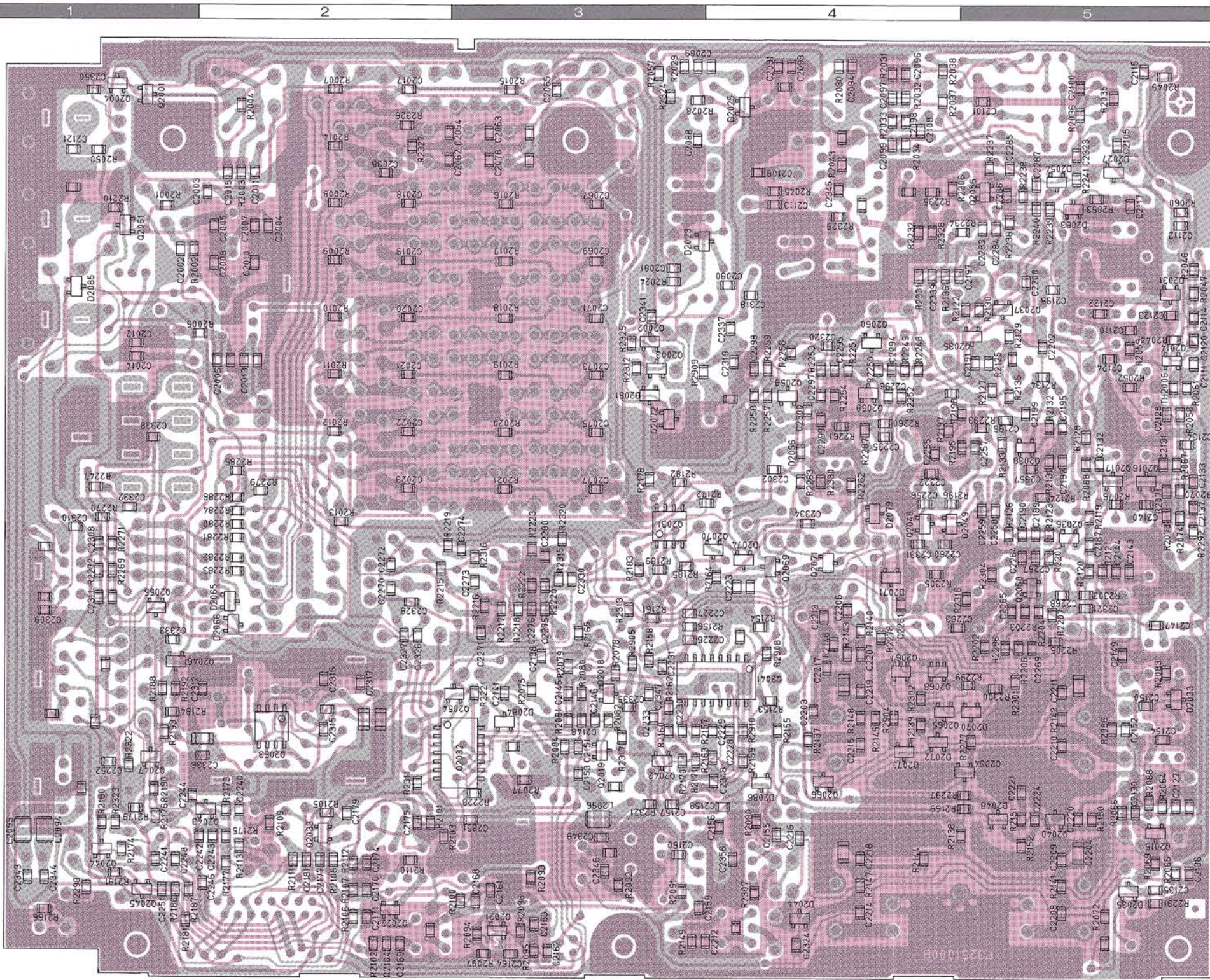

MC3372ML (Q2041)

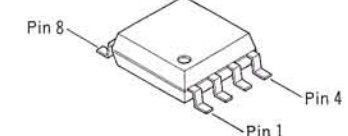

M5223FP (Q2031)
IR3M03N2 (Q2063)

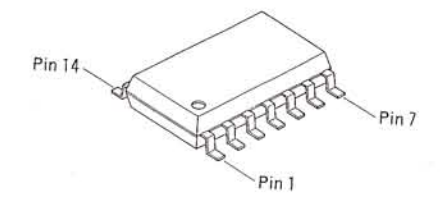

μPD4011BG (Q2032)

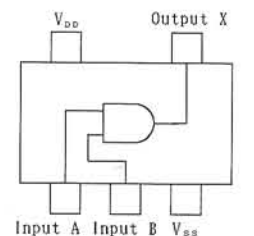

TC4S81F (C2) (Q2067, 2068)

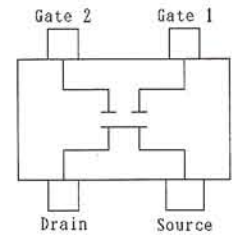

3SK131 (V11)
(Q2014, 2021, 2022, 2033, 2036, 2038, 2050, 2056)

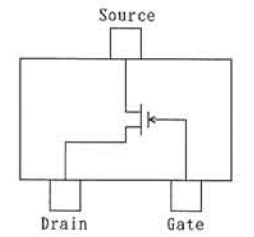

2SK302Y (TY)
(Q2016, 2017, 2040, 2048, 2049)

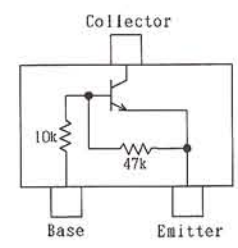

FA1A4P (L34)
(Q2004, 2042, 2046, 2055, 2061, 2064, 2065, 2066, 2069, 2071)

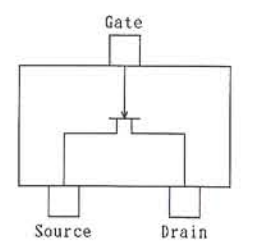

2SK160 (K6) (Q2047)

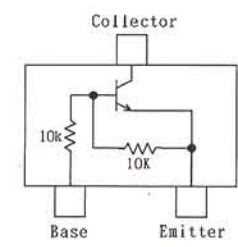

FA1A4M (L33) (Q2001, 2003)

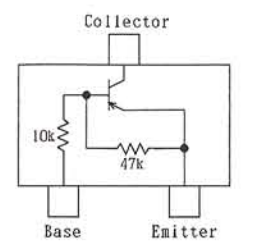

FN1A4P (M34)
(Q2002, 2060, 2070, 2072)

"chip-only" side

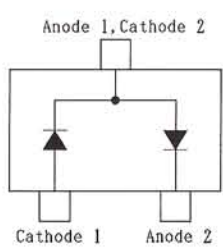

1SS226 (C3) (D2033, 2044)

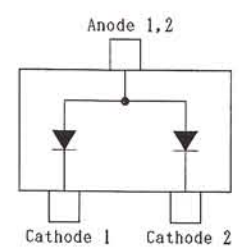

1SS181 (A3) (D2048, 2065, 2066, 2084)

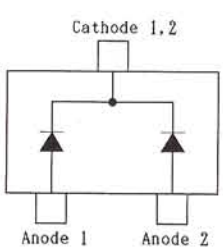

1SS184 (B3)
(D2023, 2025, 2027, 2031, 2035, 2054, 2070, 2071, 2072, 2073, 2074, 2079, 2081, 2083, 2085, 2086)

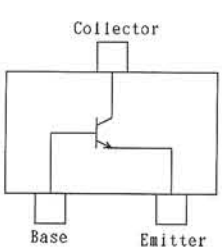

2SC2712GR (LG) (Q2035, 2037, 2043, 2044, 2045, 2054)
2SC2714Y (JY) (Q2015, 2018, 2019, 2058, 2059)

REF.	DESCRIPTION	VALUE	WV	TOL.	MFGR'S DESIG	YAESU P/N	VERS.	Addr
*** RF UNIT ***								
	PCB W COMP.					CA0568001		
	RF, NOTCH UNIT W COMP.					CP3559001		
	PCB W/O COMP.					F3251000B		
C 2002	CHIP CAP.	0.047uF	50V	F	GRM40F473Z50PT	K22171008		
C 2003	CHIP CAP.	0.047uF	50V	F	GRM40F473Z50PT	K22171008		
C 2004	CHIP CAP.	68pF	50V	CH	GRM40CH680J50PT	K22170231		
C 2005	CHIP CAP.	22pF	50V	CH	GRM40CH220J50PT	K22170219		
C 2006	CHIP CAP.	0.01uF	50V	B	GRM40B103M50PT	K22170817		
C 2007	CHIP CAP.	150pF	50V	CH	GRM40CH151J50PT	K22170239		
C 2008	CHIP CAP.	6pF	50V	CH	GRM40CH060D50PT	K22170207		
C 2009	AL. ELECTRO. CAP.	1uF	50V		50V010M4X7TR2	K46170030		
C 2010	CHIP CAP.	68pF	50V	CH	GRM40CH680J50PT	K22170231		
C 2011	CHIP CAP.	0.047uF	50V	F	GRM40F473Z50PT	K22171008		
C 2012	CHIP CAP.	0.047uF	50V	F	GRM40F473Z50PT	K22171008		
C 2013	CHIP CAP.	0.01uF	50V	B	GRM40B103M50PT	K22170817		
C 2014	CHIP CAP.	0.047uF	50V	F	GRM40F473Z50PT	K22171008		
C 2015	CHIP CAP.	0.047uF	50V	F	GRM40F473Z50PT	K22171008		
C 2016	AL. ELECTRO. CAP.	1uF	50V		50V010M4X7TR2	K46170030		
C 2017	CHIP CAP.	0.01uF	50V	B	GRM40B103M50PT	K22170817		
C 2018	CHIP CAP.	0.01uF	50V	B	GRM40B103M50PT	K22170817		
C 2019	CHIP CAP.	0.01uF	50V	B	GRM40B103M50PT	K22170817		
C 2020	CHIP CAP.	0.01uF	50V	B	GRM40B103M50PT	K22170817		
C 2021	CHIP CAP.	0.01uF	50V	B	GRM40B103M50PT	K22170817		
C 2022	CHIP CAP.	0.01uF	50V	B	GRM40B103M50PT	K22170817		
C 2023	CHIP CAP.	0.01uF	50V	B	GRM40B103M50PT	K22170817		
C 2024	CERAMIC CAP.	470pF	50V	SL	DD109-979SL471J50	K26171045		
C 2025	AL. ELECTRO. CAP.	1uF	50V		50V010M4X7TR2	K46170030		
C 2026	CERAMIC CAP.	240p	50V	SL	DD107-979SL241J50	K26171038		
C 2027	AL. ELECTRO. CAP.	1uF	50V		50V010M4X7TR2	K46170030		
C 2028	CERAMIC CAP.	150pF	50V	SL	DD106-979SL151J50	K26171033		
C 2029	AL. ELECTRO. CAP.	1uF	50V		50V010M4X7TR2	K46170030		
C 2030	CERAMIC CAP.	120pF	50V	SL	DD105-979SL121J50	K26171031		
C 2031	AL. ELECTRO. CAP.	1uF	50V		50V010M4X7TR2	K46170030		
C 2032	CERAMIC CAP.	82pF	50V	SL	DD104-979SL820J50	K26171027		
C 2033	AL. ELECTRO. CAP.	1uF	50V		50V010M4X7TR2	K46170030		
C 2034	CERAMIC CAP.	56pF	50V	SL	DD104-979SL560J50	K26171023		
C 2035	AL. ELECTRO. CAP.	1uF	50V		50V010M4X7TR2	K46170030		
C 2036	CERAMIC CAP.	39pF	50V	SL	DD104-979SL390J50	K26171019		
C 2037	AL. ELECTRO. CAP.	1uF	50V		50V010M4X7TR2	K46170030		
C 2038	CHIP CAP.	0.047uF	50V	F	GRM40F473Z50PT	K22171008		
C 2039	AL. ELECTRO. CAP.	1uF	50V		50V010M4X7TR2	K46170030		
C 2040	CERAMIC CAP.	220pF	50V	SL	DD107-979SL221J50	K26171037		
C 2041	CERAMIC CAP.	160p	50V	SL	DD106-979SL161J50	K26171034		
C 2042	CERAMIC CAP.	91p	50V	SL	DD105-979SL910J50	K26171028		
C 2043	CERAMIC CAP.	47pF	50V	SL	DD104-979SL470J50	K26171021		
C 2044	CERAMIC CAP.	33pF	50V	SL	DD104-979SL330J50	K26171017		
C 2045	CERAMIC CAP.	24p	50V	SL	DD104-979SL240J50	K26171014		
C 2046	CERAMIC CAP.	15pF	50V	SL	DD104-979SL150J50	K26171009		
C 2047	CERAMIC CAP.	0.001uF	50V	B	UP050B102K-A-B	K28179001		
C 2048	CERAMIC CAP.	430p	50V	SL	DD109-979SL431J50	K26171044		
C 2049	CERAMIC CAP.	270pF	50V	SL	DD107-979SL271J50	K26171039		
C 2050	CERAMIC CAP.	220pF	50V	SL	DD107-979SL221J50	K26171037		

RF Unit

REF.	DESCRIPTION	VALUE	WV	TOL.	MFGR'S DESIG	YAESU P/N	VERS.	Addr
C 2051	CERAMIC CAP.	160p	50V	SL	DD106-979SL161J50	K26171034		
C 2052	CERAMIC CAP.	100pF	50V	SL	DD105-979SL101J50	K26171029		
C 2053	CERAMIC CAP.	82pF	50V	SL	DD104-979SL820J50	K26171027		
C 2054	CHIP CAP.	150pF	50V	CH	GRM40CH151J50PT	K22170239		
C 2055	CERAMIC CAP.	220pF	50V	SL	DD107-979SL221J50	K26171037		
C 2056	CERAMIC CAP.	160p	50V	SL	DD106-979SL161J50	K26171034		
C 2057	CERAMIC CAP.	91p	50V	SL	DD105-979SL910J50	K26171028		
C 2058	CERAMIC CAP.	47pF	50V	SL	DD104-979SL470J50	K26171021		
C 2059	CERAMIC CAP.	33pF	50V	SL	DD104-979SL330J50	K26171017		
C 2060	CERAMIC CAP.	24p	50V	SL	DD104-979SL240J50	K26171014		
C 2061	CERAMIC CAP.	15pF	50V	SL	DD104-979SL150J50	K26171009		
C 2062	CHIP CAP.	330pF	50V	CH	GRM40CH331J50PT	K22170247		
C 2063	CHIP CAP.	330pF	50V	CH	GRM40CH331J50PT	K22170247		
C 2064	CERAMIC CAP.	470pF	50V	SL	DD109-979SL471J50	K26171045		
C 2065	CHIP CAP.	0.047uF	50V	F	GRM40F473Z50PT	K22171008		
C 2066	CERAMIC CAP.	240p	50V	SL	DD107-979SL241J50	K26171038		
C 2067	CHIP CAP.	0.047uF	50V	F	GRM40F473Z50PT	K22171008		
C 2068	CERAMIC CAP.	150pF	50V	SL	DD106-979SL151J50	K26171033		
C 2069	CHIP CAP.	0.047uF	50V	F	GRM40F473Z50PT	K22171008		
C 2070	CERAMIC CAP.	120pF	50V	SL	DD105-979SL121J50	K26171031		
C 2071	CHIP CAP.	0.047uF	50V	F	GRM40F473Z50PT	K22171008		
C 2072	CERAMIC CAP.	82pF	50V	SL	DD104-979SL820J50	K26171027		
C 2073	CHIP CAP.	0.01uF	50V	B	GRM40B103M50PT	K22170817		
C 2074	CERAMIC CAP.	56pF	50V	SL	DD104-979SL560J50	K26171023		
C 2075	CHIP CAP.	0.01uF	50V	B	GRM40B103M50PT	K22170817		
C 2076	CERAMIC CAP.	39pF	50V	SL	DD104-979SL390J50	K26171019		
C 2077	CHIP CAP.	0.01uF	50V	B	GRM40B103M50PT	K22170817		
C 2078	CHIP CAP.	150pF	50V	CH	GRM40CH151J50PT	K22170239		
C 2079	AL. ELECTRO. CAP.	1uF	50V		50V010M4X7TR2	K46170030		
C 2080	CHIP CAP.	0.047uF	50V	F	GRM40F473Z50PT	K22171008		
C 2081	CHIP CAP.	0.047uF	50V	F	GRM40F473Z50PT	K22171008		
C 2082	AL. ELECTRO. CAP.	1uF	50V		50V010M4X7TR2	K46170030		
C 2087	AL. ELECTRO. CAP.	1uF	50V		50V010M4X7TR2	K46170030		
C 2088	CHIP CAP.	0.01uF	50V	B	GRM40B103M50PT	K22170817		
C 2089	CHIP CAP.	0.01uF	50V	B	GRM40B103M50PT	K22170817		
C 2090	AL. ELECTRO. CAP.	1uF	50V		50V010M4X7TR2	K46170030		
C 2091	CHIP CAP.	68pF	50V	CH	GRM40CH680J50PT	K22170231		
C 2093	CHIP CAP.	68pF	50V	CH	GRM40CH680J50PT	K22170231		
C 2094	CHIP CAP.	0.047uF	50V	F	GRM40F473Z50PT	K22171008		
C 2095	AL. ELECTRO. CAP.	1uF	50V		50V010M4X7TR2	K46170030		
C 2096	CHIP CAP.	0.047uF	50V	F	GRM40F473Z50PT	K22171008		
C 2097	CHIP CAP.	0.047uF	50V	F	GRM40F473Z50PT	K22171008		
C 2098	CHIP CAP.	0.047uF	50V	F	GRM40F473Z50PT	K22171008		
C 2099	CHIP CAP.	0.047uF	50V	F	GRM40F473Z50PT	K22171008		
C 2100	CHIP CAP.	0.047uF	50V	F	GRM40F473Z50PT	K22171008		
C 2101	CHIP CAP.	0.01uF	50V	B	GRM40B103M50PT	K22170817		
C 2105	CHIP CAP.	0.001uF	50V	B	GRM40B102M50PT	K22170805		
C 2108	CHIP CAP.	0.01uF	50V	B	GRM40B103M50PT	K22170817		
C 2109	CHIP CAP.	150pF	50V	CH	GRM40CH151J50PT	K22170239		
C 2110	CHIP CAP.	0.01uF	50V	B	GRM40B103M50PT	K22170817		
C 2111	CHIP CAP.	0.01uF	50V	B	GRM40B103M50PT	K22170817		
C 2112	CHIP CAP.	0.01uF	50V	B	GRM40B103M50PT	K22170817		
C 2113	CHIP CAP.	0.01uF	50V	B	GRM40B103M50PT	K22170817		
C 2114	CHIP CAP.	0.01uF	50V	B	GRM40B103M50PT	K22170817		
C 2115	CHIP CAP.	0.01uF	50V	B	GRM40B103M50PT	K22170817		
C 2117	CHIP CAP.	0.01uF	50V	B	GRM40B103M50PT	K22170817		

REF.	DESCRIPTION	VALUE	WV	TOL.	MFGR'S DESIG	YAESU P/N	VERS.	Addr
C 2120	CHIP CAP.	0.01uF	50V	B	GRM40B103M50PT	K22170817		
C 2121	CHIP CAP.	0.01uF	50V	B	GRM40B103M50PT	K22170817		
C 2122	CHIP CAP.	0.001uF	50V	B	GRM40B102M50PT	K22170805		
C 2123	CHIP CAP.	100pF	50V	CH	GRM40CH101J50PT	K22170235		
C 2124	CHIP CAP.	0.01uF	50V	B	GRM40B103M50PT	K22170817		
C 2127	CHIP CAP.	0.0068uF	50V	B	GRM40B682M50PT	K22170815		
C 2128	CHIP CAP.	0.01uF	50V	B	GRM40B103M50PT	K22170817		
C 2130	CHIP CAP.	0.01uF	50V	B	GRM40B103M50PT	K22170817		
C 2131	CHIP CAP.	0.001uF	50V	B	GRM40B102M50PT	K22170805		
C 2132	CHIP CAP.	0.001uF	50V	B	GRM40B102M50PT	K22170805		
C 2133	CHIP CAP.	0.001uF	50V	B	GRM40B102M50PT	K22170805		
C 2134	CHIP CAP.	0.001uF	50V	B	GRM40B102M50PT	K22170805		
C 2135	CHIP CAP.	0.01uF	50V	B	GRM40B103M50PT	K22170817		
C 2136	CHIP CAP.	0.01uF	50V	B	GRM40B103M50PT	K22170817		
C 2137	CHIP CAP.	0.01uF	50V	B	GRM40B103M50PT	K22170817		
C 2138	CHIP CAP.	0.01uF	50V	B	GRM40B103M50PT	K22170817		
C 2140	CHIP CAP.	0.01uF	50V	B	GRM40B103M50PT	K22170817		
C 2141	CHIP CAP.	3pF	50V	UJ	GRM40UJ030C50PT	K22170304		
C 2143	CHIP CAP.	0.01uF	50V	B	GRM40B103M50PT	K22170817		
C 2144	CHIP CAP.	100pF	50V	CH	GRM40CH101J50PT	K22170235		
C 2145	CHIP CAP.	330pF	50V	UJ	GRM40UJ331J50PT	K22170347		
C 2146	CHIP CAP.	330pF	50V	UJ	GRM40UJ331J50PT	K22170347		
C 2147	CHIP CAP.	100pF	50V	CH	GRM40CH101J50PT	K22170235		
C 2148	CHIP CAP.	330pF	50V	UJ	GRM40UJ331J50PT	K22170347		
C 2149	CHIP CAP.	0.047uF	50V	F	GRM40F473Z50PT	K22171008		
C 2150	CHIP CAP.	0.047uF	50V	F	GRM40F473Z50PT	K22171008		
C 2151	CHIP CAP.	0.01uF	50V	B	GRM40B103M50PT	K22170817		
C 2152	CHIP CAP.	0.047uF	50V	F	GRM40F473Z50PT	K22171008		
C 2153	CHIP CAP.	0.01uF	50V	B	GRM40B103M50PT	K22170817		
C 2154	CHIP CAP.	0.047uF	50V	F	GRM40F473Z50PT	K22171008		
C 2155	CHIP CAP.	0.047uF	50V	F	GRM40F473Z50PT	K22171008		
C 2156	CHIP CAP.	0.047uF	50V	F	GRM40F473Z50PT	K22171008		
C 2157	CHIP CAP.	0.01uF	50V	B	GRM40B103M50PT	K22170817		
C 2158	CHIP CAP.	0.047uF	50V	F	GRM40F473Z50PT	K22171008		
C 2159	CHIP CAP.	0.047uF	50V	F	GRM40F473Z50PT	K22171008		
C 2160	CHIP CAP.	0.01uF	50V	B	GRM40B103M50PT	K22170817		
C 2161	CHIP CAP.	0.01uF	50V	B	GRM40B103M50PT	K22170817		
C 2162	CHIP CAP.	0.01uF	50V	B	GRM40B103M50PT	K22170817		
C 2163	CHIP CAP.	0.047uF	50V	F	GRM40F473Z50PT	K22171008		
C 2164	CHIP CAP.	0.047uF	50V	F	GRM40F473Z50PT	K22171008		
C 2168	CHIP CAP.	0.047uF	50V	F	GRM40F473Z50PT	K22171008		
C 2169	CHIP CAP.	0.047uF	50V	F	GRM40F473Z50PT	K22171008		
C 2170	CHIP CAP.	0.1uF	25V	F	GRM40F104Z25PT	K22141005		
C 2171	CHIP CAP.	0.01uF	50V	B	GRM40B103M50PT	K22170817		
C 2174	CHIP CAP.	0.01uF	50V	B	GRM40B103M50PT	K22170817		
C 2175	CHIP CAP.	0.047uF	50V	F	GRM40F473Z50PT	K22171008		
C 2177	CHIP CAP.	0.1uF	25V	F	GRM40F104Z25PT	K22141005		
C 2179	CHIP CAP.	0.01uF	50V	B	GRM40B103M50PT	K22170817		
C 2181	CHIP CAP.	0.1uF	25V	F	GRM40F104Z25PT	K22141005		
C 2187	CHIP CAP.	0.01uF	50V	B	GRM40B103M50PT	K22170817		
C 2188	AL. ELECTRO. CAP.	10uF	16V		16V100M4X7TR2	K46120004		
C 2189	CHIP CAP.	0.047uF	50V	F	GRM40F473Z50PT	K22171008		
C 2190	CHIP CAP.	0.1uF	25V	F	GRM40F104Z25PT	K22141005		
C 2191	CHIP CAP.	0.022uF	50V	B	GRM40B223M50PT	K22170821		
C 2192	CHIP CAP.	0.047uF	50V	F	GRM40F473Z50PT	K22171008		
C 2193	AL. ELECTRO. CAP.	10uF	16V		16V100M4X7TR2	K46120004		

RF Unit

REF.	DESCRIPTION	VALUE	WV	TOL.	MFGR'S DESIG	YAESU P/N	VERS.	Addr
C 2195	CHIP CAP.	0.01uF	50V	B	GRM40B103M50PT	K22170817		
C 2196	CHIP CAP.	0.047uF	50V	F	GRM40F473Z50PT	K22171008		
C 2197	CHIP CAP.	0.001uF	50V	B	GRM40B102M50PT	K22170805		
C 2198	CHIP CAP.	0.01uF	50V	B	GRM40B103M50PT	K22170817		
C 2199	CHIP CAP.	0.1uF	25V	F	GRM40F104Z25PT	K22141005		
C 2200	CHIP CAP.	0.001uF	50V	B	GRM40B102M50PT	K22170805		
C 2201	AL. ELECTRO. CAP.	10uF	16V		16V100M4X7TR2	K46120004		
C 2202	CHIP CAP.	0.001uF	50V	B	GRM40B102M50PT	K22170805		
C 2203	CHIP CAP.	0.1uF	25V	F	GRM40F104Z25PT	K22141005		
C 2204	CHIP CAP.	0.1uF	25V	F	GRM40F104Z25PT	K22141005		
C 2206	CHIP CAP.	0.01uF	50V	B	GRM40B103M50PT	K22170817		
C 2207	CHIP CAP.	0.01uF	50V	B	GRM40B103M50PT	K22170817		
C 2208	CHIP CAP.	0.01uF	50V	B	GRM40B103M50PT	K22170817		
C 2209	CHIP CAP.	0.01uF	50V	B	GRM40B103M50PT	K22170817		
C 2210	CHIP CAP.	0.01uF	50V	B	GRM40B103M50PT	K22170817		
C 2211	CHIP CAP.	0.01uF	50V	B	GRM40B103M50PT	K22170817		
C 2212	CHIP CAP.	0.047uF	50V	F	GRM40F473Z50PT	K22171008		
C 2213	CHIP CAP.	0.01uF	50V	B	GRM40B103M50PT	K22170817		
C 2214	CHIP CAP.	0.01uF	50V	B	GRM40B103M50PT	K22170817		
C 2215	CHIP CAP.	0.01uF	50V	B	GRM40B103M50PT	K22170817		
C 2216	CHIP CAP.	22pF	50V	CH	GRM40CH220J50PT	K22170219		
C 2217	CHIP CAP.	0.047uF	50V	F	GRM40F473Z50PT	K22171008		
C 2218	CHIP CAP.	0.047uF	50V	F	GRM40F473Z50PT	K22171008		
C 2219	CHIP CAP.	0.047uF	50V	F	GRM40F473Z50PT	K22171008		
C 2220	CHIP CAP.	0.047uF	50V	F	GRM40F473Z50PT	K22171008		
C 2221	CHIP CAP.	0.047uF	50V	F	GRM40F473Z50PT	K22171008		
C 2222	AL. ELECTRO. CAP.	1uF	50V		50V010M4X7TR2	K46170030		
C 2223	CHIP CAP.	0.01uF	50V	B	GRM40B103M50PT	K22170817		
C 2224	CHIP CAP.	0.01uF	50V	B	GRM40B103M50PT	K22170817		
C 2225	AL. ELECTRO. CAP.	3.3uF	50V		50V3R3M4X7TR2	K46170032		
C 2226	CHIP CAP.	0.1uF	25V	F	GRM40F104Z25PT	K22141005		
C 2227	CHIP CAP.	0.1uF	25V	F	GRM40F104Z25PT	K22141005		
C 2228	CHIP CAP.	0.1uF	25V	F	GRM40F104Z25PT	K22141005		
C 2229	CHIP CAP.	0.001uF	50V	B	GRM40B102M50PT	K22170805		
C 2230	CHIP CAP.	0.001uF	50V	B	GRM40B102M50PT	K22170805		
C 2231	CHIP CAP.	120pF	50V	CH	GRM40CH121J50PT	K22170237		
C 2233	CHIP CAP.	0.1uF	25V	F	GRM40F104Z25PT	K22141005		
C 2235	CHIP CAP.	0.0068uF	50V	B	GRM40B682M50PT	K22170815		
C 2240	CHIP CAP.	470pF	50V	CH	GRM40CH471J50PT	K22170251		
C 2241	CHIP CAP.	100pF	50V	CH	GRM40CH101J50PT	K22170235		
C 2242	CHIP CAP.	470pF	50V	CH	GRM40CH471J50PT	K22170251		
C 2243	CHIP CAP.	470pF	50V	CH	GRM40CH471J50PT	K22170251		
C 2244	CHIP CAP.	0.01uF	50V	B	GRM40B103M50PT	K22170817		
C 2245	AL. ELECTRO. CAP.	1uF	50V		50V010M4X7TR2	K46170030		
C 2246	CHIP CAP.	0.0047uF	50V	B	GRM40B472M50PT	K22170813		
C 2247	TANTALUM CAP.	0.22uF	35V		DN1VR22M1S	K70167224		
C 2248	CHIP CAP.	0.1uF	25V	F	GRM40F104Z25PT	K22141005		
C 2249	AL. ELECTRO. CAP.	100uF	10V		RC2-10V101M	K40109015		
C 2250	TANTALUM CAP.	1.5	35V		DN1V1R5M1S	K70167155		
C 2251	CHIP CAP.	470pF	50V	CH	GRM40CH471J50PT	K22170251		
C 2252	CHIP CAP.	0.01uF	50V	B	GRM40B103M50PT	K22170817		
C 2253	AL. ELECTRO. CAP.	1uF	50V		50V010M4X7TR2	K46170030		
C 2254	AL. ELECTRO. CAP.	100uF	16V		16V101M6X7TR2	K46120007		
C 2255	CHIP CAP.	0.01uF	50V	B	GRM40B103M50PT	K22170817		
C 2256	CHIP CAP.	0.047uF	50V	F	GRM40F473Z50PT	K22171008		
C 2257	CHIP CAP.	0.01uF	50V	B	GRM40B103M50PT	K22170817		

REF.	DESCRIPTION	VALUE	WV	TOL.	MFR'S DESIG	YAESU P/N	VERS.	Addr
C 2258	CHIP CAP.	0.01uF	50V	B	GRM40B103M50PT	K22170817		
C 2259	CHIP CAP.	0.01uF	50V	B	GRM40B103M50PT	K22170817		
C 2260	CHIP CAP.	0.01uF	50V	B	GRM40B103M50PT	K22170817		
C 2261	CHIP CAP.	0.001uF	50V	B	GRM40B102M50PT	K22170805		
C 2263	CHIP CAP.	0.001uF	50V	B	GRM40B102M50PT	K22170805		
C 2264	CHIP CAP.	0.01uF	50V	B	GRM40B103M50PT	K22170817		
C 2265	CHIP CAP.	0.1uF	25V	B	GRM40B104M25PT	K22140811		
C 2267	CHIP CAP.	0.047uF	50V	F	GRM40F473Z50PT	K22171008		
C 2268	CHIP CAP.	0.047uF	50V	F	GRM40F473Z50PT	K22171008		
C 2269	CHIP CAP.	0.047uF	50V	F	GRM40F473Z50PT	K22171008		
C 2270	CHIP CAP.	0.047uF	50V	F	GRM40F473Z50PT	K22171008		
C 2271	CHIP CAP.	0.001uF	50V	B	GRM40B102M50PT	K22170805		
C 2272	CHIP CAP.	0.1uF	25V	F	GRM40F104Z25PT	K22141005		
C 2273	CHIP CAP.	0.047uF	50V	F	GRM40F473Z50PT	K22171008		
C 2274	CHIP CAP.	0.047uF	50V	F	GRM40F473Z50PT	K22171008		
C 2275	CHIP CAP.	0.01uF	50V	B	GRM40B103M50PT	K22170817		
C 2276	CHIP CAP.	0.01uF	50V	B	GRM40B103M50PT	K22170817		
C 2278	AL. ELECTRO. CAP.	2.2uF	50V		50V2R2M4X7TR2	K46170031		
C 2279	AL. ELECTRO. CAP.	10uF	16V		16V100M4X7TR2	K46120004		
C 2280	CHIP CAP.	0.047uF	50V	F	GRM40F473Z50PT	K22171008		
C 2283	CHIP CAP.	0.001uF	50V	B	GRM40B102M50PT	K22170805		
C 2284	CHIP CAP.	0.01uF	50V	B	GRM40B103M50PT	K22170817		
C 2285	CHIP CAP.	0.047uF	50V	F	GRM40F473Z50PT	K22171008		
C 2286	CHIP CAP.	0.01uF	50V	B	GRM40B103M50PT	K22170817		
C 2287	CHIP CAP.	0.0068uF	50V	B	GRM40B682M50PT	K22170815		
C 2294	CHIP CAP.	0.01uF	50V	B	GRM40B103M50PT	K22170817		
C 2295	CHIP CAP.	0.01uF	50V	B	GRM40B103M50PT	K22170817		
C 2296	CHIP CAP.	0.01uF	50V	B	GRM40B103M50PT	K22170817		
C 2297	CHIP CAP.	5pF	50V	CH	GRM40CH050C50PT	K22170206		
C 2298	CHIP CAP.	0.01uF	50V	B	GRM40B103M50PT	K22170817		
C 2299	CHIP CAP.	33pF	50V	UJ	GRM40UJ330J50PT	K22170323		
C 2300	CHIP CAP.	33pF	50V	UJ	GRM40UJ330J50PT	K22170323		
C 2302	CHIP CAP.	0.001uF	50V	B	GRM40B102M50PT	K22170805		
C 2308	CHIP CAP.	0.001uF	50V	B	GRM40B102M50PT	K22170805		
C 2309	CHIP CAP.	0.001uF	50V	B	GRM40B102M50PT	K22170805		
C 2310	CHIP CAP.	0.001uF	50V	B	GRM40B102M50PT	K22170805		
C 2311	CHIP CAP.	0.001uF	50V	B	GRM40B102M50PT	K22170805		
C 2312	CHIP CAP.	0.01uF	50V	B	GRM40B103M50PT	K22170817		
C 2313	AL. ELECTRO. CAP.	100uF	16V		16V101M6X7TR2	K46120007		
C 2314	AL. ELECTRO. CAP.	100uF	16V		16V101M6X7TR2	K46120007		
C 2315	CHIP CAP.	560pF	50V	B	GRM40B561M50PT	K22170802		
C 2316	CHIP CAP.	0.01uF	50V	B	GRM40B103M50PT	K22170817		
C 2317	CHIP CAP.	0.047uF	50V	F	GRM40F473Z50PT	K22171008		
C 2318	CHIP CAP.	82pF	50V	CH	GRM40CH820J50PT	K22170233		
C 2319	CHIP CAP.	82pF	50V	CH	GRM40CH820J50PT	K22170233		
C 2320	CHIP CAP.	0.001uF	50V	B	GRM40B102M50PT	K22170805		
C 2321	CHIP CAP.	0.047uF	50V	F	GRM40F473Z50PT	K22171008		
C 2322	CHIP CAP.	3pF	50V	CJ	GRM40CJ030C50PT	K22170204		
C 2323	CHIP CAP.	0.01uF	50V	B	GRM40B103M50PT	K22170817		
C 2324	CHIP CAP.	22pF	50V	CH	GRM40CH220J50PT	K22170219		
C 2325	AL. ELECTRO. CAP.	100uF	16V		16V101M6X7TR2	K46120007		
C 2326	CHIP CAP.	68pF	50V	CH	GRM40CH680J50PT	K22170231		
C 2327	CHIP CAP.	68pF	50V	CH	GRM40CH680J50PT	K22170231		
C 2328	CHIP CAP.	22pF	50V	CH	GRM40CH220J50PT	K22170219		
C 2329	AL. ELECTRO. CAP.	10uF	16V		16V100M4X7TR2	K46120004		
C 2330	CHIP CAP.	0.047uF	50V	F	GRM40F473Z50PT	K22171008		

RF Unit

REF.	DESCRIPTION	VALUE	WV	TOL.	MFGR'S DESIG	YAESU P/N	VERS.	Addr
C 2331	CHIP CAP.	0.047uF	50V	F	GRM40F473Z50PT	K22171008		
C 2332	CHIP CAP.	0.001uF	50V	B	GRM40B102M50PT	K22170805		
C 2333	CHIP CAP.	0.047uF	50V	F	GRM40F473Z50PT	K22171008		
C 2334	CHIP CAP.	0.047uF	50V	F	GRM40F473Z50PT	K22171008		
C 2335	CHIP CAP.	0.01uF	50V	B	GRM40B103M50PT	K22170817		
C 2336	CHIP CAP.	0.1uF	25V	B	GRM40B104M25PT	K22140811		
C 2337	CHIP CAP.	8pF	50V	CH	GRM40CH080D50PT	K22170209		
C 2338	CHIP CAP.	0.001uF	50V	B	GRM40B102M50PT	K22170805		
C 2339	CHIP CAP.	0.047uF	50V	F	GRM40F473Z50PT	K22171008		
C 2340	TANTALUM CHIP CAP.	6.8uF	16V		F951C685MWCAF1	K78120004		
C 2341	CHIP CAP.	0.1uF	25V	B	GRM40B104M25PT	K22140811		
C 2342	CERAMIC CAP.	0.01uF	16V	Y	EP050Y103N-A	K28129001		
C 2343	CHIP CAP.	0.01uF	50V	B	GRM40B103M50PT	K22170817		
C 2344	CHIP CAP.	0.01uF	50V	B	GRM40B103M50PT	K22170817		
C 2345	CHIP CAP.	0.01uF	50V	B	GRM40B103M50PT	K22170817		
C 2346	CHIP CAP.	0.01uF	50V	B	GRM40B103M50PT	K22170817		
C 2347	CHIP CAP.	0.022uF	50V	B	GRM40B223M50PT	K22170821		
C 2348	CHIP CAP.	33pF	50V	CH	GRM40CH330J50PT	K22170223		
C 2349	CHIP CAP.	33pF	50V	CH	GRM40CH330J50PT	K22170223		
C 2350	CHIP CAP.	0.047uF	50V	F	GRM40F473Z50PT	K22171008		
C 2351	CHIP CAP.	0.047uF	50V	F	GRM40F473Z50PT	K22171008		
C 2352	CHIP CAP.	0.047uF	50V	F	GRM40F473Z50PT	K22171008		
C 2353	TANTALUM CAP.	10uF	10V		DN1A100M1S	K70107106		
C 2354	CERAMIC CAP.	22pF	50V	CH	DD104CH220J50	K02179009		
C 2355	TANTALUM CAP.	10uF	10V		DN1A100M1S	K70107106		
C 2356	CHIP CAP.	47pF	50V	CH	GRM40CH470J50PT	K22170227		
C 2357	CHIP CAP.	68pF	50V	CH	GRM40CH680J50PT	K22170231		
C 2358	TANTALUM CAP.	10uF	10V		DN1A100M1S	K70107106		
CD2001	CERAMIC DISC				CDB455C7	H7900180		
CF2001	CERAMIC FILTER				LF-H6SC	H3900377		
CF2002	CERAMIC FILTER				CFJ455K15	H3900398		
CF2004	CERAMIC FILTER				LF-H8S	H3900387		
D 2001	DIODE				1SS83RE	G2050007		
D 2002	DIODE				1SS83RE	G2050007		
D 2003	DIODE				1SS270TJ	G2060004		
D 2004	DIODE				1SS270TJ	G2060004		
D 2005	DIODE				1SS83RE	G2050007		
D 2006	DIODE				1SS83RE	G2050007		
D 2007	DIODE				1SS83RE	G2050007		
D 2008	DIODE				1SS83RE	G2050007		
D 2009	DIODE				1SS83RE	G2050007		
D 2010	DIODE				1SS83RE	G2050007		
D 2011	DIODE				1SS83RE	G2050007		
D 2012	DIODE				1SS83RE	G2050007		
D 2013	DIODE				1SS83RE	G2050007		
D 2014	DIODE				1SS83RE	G2050007		
D 2015	DIODE				1SS83RE	G2050007		
D 2016	DIODE				1SS83RE	G2050007		
D 2017	DIODE				1SS83RE	G2050007		
D 2018	DIODE				1SS83RE	G2050007		
D 2019	DIODE				1SS83RE	G2050007		
D 2020	DIODE				1SS83RE	G2050007		
D 2021	DIODE				1SS83RE	G2050007		

REF.	DESCRIPTION	VALUE	WV	TOL.	MFGR'S DESIG	YAESU P/N	VERS.	Addr
D 2022	DIODE				1SS83RE	G2050007		
D 2023	DIODE				1SS184 TE85R	G2070009		
D 2025	DIODE				1SS184 TE85R	G2070009		
D 2027	DIODE				1SS184 TE85R	G2070009		
D 2030	DIODE				1SS270TJ	G2060004		
D 2031	DIODE				1SS184 TE85R	G2070009		
D 2032	DIODE				1SV50	G2090023		
D 2033	DIODE				1SS226 TE85R	G2070003		
D 2034	DIODE				1SS270TJ	G2060004		
D 2035	DIODE				1SS184 TE85R	G2070009		
D 2036	DIODE				1SS270TJ	G2060004		
D 2037	DIODE				1SS270TJ	G2060004		
D 2038	DIODE				1SS106	G2090244		
D 2039	DIODE				1SS106	G2090244		
D 2040	DIODE				1SS270TJ	G2060004		
D 2041	DIODE				1SS270TJ	G2060004		
D 2042	DIODE				1SS270TJ	G2060004		
D 2043	DIODE				1SS270TJ	G2060004		
D 2044	DIODE				1SS226 TE85R	G2070003		
D 2045	DIODE				1SS270TJ	G2060004		
D 2046	DIODE				1SS270TJ	G2060004		
D 2047	DIODE				1SS270TJ	G2060004		
D 2048	DIODE				1SS181 TE85R	G2070001		
D 2049	DIODE				1SS270TJ	G2060004		
D 2050	DIODE				1SS106	G2090244		
D 2051	DIODE				1SS106	G2090244		
D 2052	DIODE				1SS106	G2090244		
D 2053	DIODE				1SS270TJ	G2060004		
D 2054	DIODE				1SS184 TE85R	G2070009		
D 2056	DIODE				HVU306A5TRF	G2070132		
D 2057	DIODE				1SS270TJ	G2060004		
D 2058	DIODE				1SS270TJ	G2060004		
D 2059	DIODE				1SS270TJ	G2060004		
D 2060	DIODE				1SS270TJ	G2060004		
D 2061	DIODE				1SS270TJ	G2060004		
D 2062	DIODE				1SS270TJ	G2060004		
D 2063	DIODE				1SS270TJ	G2060004		
D 2064	DIODE				1SS270TJ	G2060004		
D 2065	DIODE				1SS181 TE85R	G2070001		
D 2066	DIODE				1SS181 TE85R	G2070001		
D 2069	DIODE				1SS83RE	G2050007		
D 2070	DIODE				1SS184 TE85R	G2070009		
D 2071	DIODE				1SS184 TE85R	G2070009		
D 2072	DIODE				1SS184 TE85R	G2070009		
D 2073	DIODE				1SS184 TE85R	G2070009		
D 2074	DIODE				1SS184 TE85R	G2070009		
D 2077	DIODE				1SS270TJ	G2060004		
D 2078	DIODE				ND487C2-3R	G2090135		
D 2079	DIODE				1SS184 TE85R	G2070009		
D 2080	DIODE				1SS270TJ	G2060004		
D 2081	DIODE				1SS184 TE85R	G2070009		
D 2083	DIODE				1SS184 TE85R	G2070009		
D 2084	DIODE				1SS181 TE85R	G2070001		
D 2085	DIODE				1SS184 TE85R	G2070009		
D 2086	DIODE				1SS184 TE85R	G2070009		

RF Unit

REF.	DESCRIPTION	VALUE	WV	TOL.	MFGR'S DESIG	YAESU P/N	VERS.	Addr
J 2001	CONNECTOR				SC25-04WS	P0090623		
J 2003	CONNECTOR				TCS7930-15-401	P1090698		
J 2004	CONNECTOR				SC25-02WS	P0090621		
J 2006	CONNECTOR				SC25-03WS	P0090622		
J 2007	CONNECTOR				SC25-02WS	P0090621		
J 2008	CONNECTOR				SC25-03WS	P0090622		
J 2009	CONNECTOR				SC25-02WS	P0090621		
J 2010	CONNECTOR				SC25-02WS	P0090621		
J 2011	CONNECTOR				52030-1610	P1090657		
J 2012	CONNECTOR				TCS7930-16-401	P1090699		
J 2013	CONNECTOR				SC25-05WS	P0090624		
J 2014	CONNECTOR				S-G4617#03	P1090351		
J 2015	CONNECTOR				SB20-02WS	P0090609		
J 2016	CONNECTOR				SC25-04WS	P0090623		
J 2017	CONNECTOR				SC25-06WS	P0090625		
J 2018	CONNECTOR				SC25-04WS	P0090623		
J 2019	CONNECTOR				SC25-02WS	P0090621		
J 2020	CONNECTOR				TCS7930-18-401	P1090700		
J 2021	CONNECTOR				SC25-02WS	P0090621		
J 2022	CONNECTOR				SC25-08WS	P0090627		
J 2023	CONNECTOR				S-Q3097-01	P1090348		
J 2024	CONNECTOR				TMP-J01X-A2	P1090255		
J 2025	CONNECTOR				S-Q3097-04	P1090354		
J 2026	CONNECTOR				TMP-J01X-A2	P1090255		
J 2027	CONNECTOR				TMP-J01X-A2	P1090255		
J 2028	CONNECTOR				S-Q3097-02	P1090296		
J 2029	CONNECTOR				TMP-J01X-A2	P1090255		
L 2001	COIL				0.170U T25-6	L0021221		
L 2002	COIL				0.240U T25-6	L0021222		
L 2003	M. RFC	10uH			LAP02TA100K	L1790058		
L 2004	M. RFC	8.2uH			LAP02TA8R2K	L1790057		
L 2005	M. RFC	4.7uH			LAP02TA4R7K	L1790054		
L 2006	M. RFC	2.7u			LAP02TA2R7K	L1790051		
L 2007	M. RFC	1.8u			LAP02TA1R8K	L1790049		
L 2008	M. RFC	1.5u			LAP02TA1R5K	L1790048		
L 2009	M. RFC	0.82uH			LAP02TAR82K	L1790045		
L 2010	M. RFC	1mH			LAL03VB102K	L1790164		
L 2011	M. RFC	27uH			LAP02TA270K	L1790063		
L 2012	M. RFC	12uH			LAP02TA120K	L1790059		
L 2013	M. RFC	8.2uH			LAP02TA8R2K	L1790057		
L 2014	M. RFC	6.8uH			LAP02TA6R8K	L1790056		
L 2015	M. RFC	4.7uH			LAP02TA4R7K	L1790054		
L 2016	M. RFC	3.3uH			LAP02TA3R3K	L1790052		
L 2017	M. RFC	2.2uH			LAP02TA2R2K	L1790050		
L 2018	M. RFC	33uH			LAP02TA330K	L1790064		
L 2019	M. RFC	6.8uH			LAP02TA6R8K	L1790056		
L 2020	M. RFC	4.7uH			LAP02TA4R7K	L1790054		
L 2021	M. RFC	2.7u			LAP02TA2R7K	L1790051		
L 2022	M. RFC	1.5u			LAP02TA1R5K	L1790048		
L 2023	M. RFC	1uH			LAP02TA1R0K	L1790046		
L 2024	M. RFC	0.82uH			LAP02TAR82K	L1790045		
L 2025	M. RFC	0.47uH			LAP02TAR47K	L1790042		
L 2026	M. RFC	33uH			LAP02TA330K	L1790064		
L 2027	M. RFC	27uH			LAP02TA270K	L1790063		
L 2028	M. RFC	12uH			LAP02TA120K	L1790059		

REF.	DESCRIPTION	VALUE	WV	TOL.	MFGR'S DESIG	YAESU P/N	VERS.	Addr
L 2029	M. RFC	8. 2uH			LAP02TA8R2K	L1790057		
L 2030	M. RFC	6. 8uH			LAP02TA6R8K	L1790056		
L 2031	M. RFC	4. 7uH			LAP02TA4R7K	L1790054		
L 2032	M. RFC	3. 3uH			LAP02TA3R3K	L1790052		
L 2033	M. RFC	2. 2uH			LAP02TA2R2K	L1790050		
L 2034	M. RFC	33uH			LAP02TA330K	L1790064		
L 2035	M. RFC	10uH			LAP02TA100K	L1790058		
L 2036	M. RFC	8. 2uH			LAP02TA8R2K	L1790057		
L 2037	M. RFC	4. 7uH			LAP02TA4R7K	L1790054		
L 2038	M. RFC	2. 7u			LAP02TA2R7K	L1790051		
L 2039	M. RFC	1. 8u			LAP02TA1R8K	L1790049		
L 2040	M. RFC	1. 5u			LAP02TA1R5K	L1790048		
L 2041	M. RFC	0. 82uH			LAP02TA82K	L1790045		
L 2043	M. RFC	1mH			LAL03VB102K	L1790164		
L 2044	M. RFC	6. 8uH			LAP02TA6R8K	L1790056		
L 2047	COIL				0. 240U T25-6	L0021222		
L 2048	M. RFC	10uH			LAP02TA100K	L1790058		
L 2050	M. RFC	1mH			LAL03TA102K	L1790119		
L 2053	M. RFC	10uH			LAP02TA100K	L1790058		
L 2061	M. RFC	47uH			LAP02TA470K	L1790066		
L 2062	COIL				8. 67M R12-L721X	L0022134		
L 2072	M. RFC	1mH			LAL03VB102K	L1790164		
L 2075	M. RFC	1mH			RCR-875D-102K	L1190392		
L 2076	M. RFC	22uH			LAP02TA220K	L1790062		
L 2077	M. RFC	22uH			LAP02TA220K	L1790062		
L 2080	M. RFC	4. 7uH			LAP02TA4R7K	L1790054		
L 2081	M. RFC	100uH			LAP02TA101K	L1790070		
L 2082	COIL				0. 75U R12-L720X	L0022133		
L 2083	M. RFC	1mH			RCR-875D-102K	L1190392		
L 2084	M. RFC	3. 9m			RCR-875D-392K	L1190383		
L 2085	M. RFC	3. 9m			RCR-875D-392K	L1190383		
L 2087	M. RFC	220uH			LAP02TA221K	L1790074		
L 2088	COIL				0. 420U T25-6	L0021245		
L 2089	M. RFC	1uH			LAP02TA1R0K	L1790046		
L 2090	M. RFC	150uH			LAP02TA151K	L1790072		
L 2091	M. RFC	22uH			LAP02TA220K	L1790062		
L 2092	COIL				0. 240U T25-6	L0021222		
L 2093	COIL	100uH			32CS 380HB-101K=P	L1690051		
L 2094	COIL	100uH			32CS 380HB-101K=P	L1690051		
L 2095	M. RFC	10uH			LAP02TA100K	L1790058		
L 2096	COIL	1. 5u			32CS 380LB-1R5M=P	L1690031		
Q 2001	TRANSISTOR				FA1A4M-T2B	G3070001		a1
Q 2002	TRANSISTOR				FN1A4P-T2B	G3070011		b3
Q 2003	TRANSISTOR				FA1A4M-T2B	G3070001		b3
Q 2004	TRANSISTOR				FA1A4P-T2B	G3070006		a1
Q 2005	FET				2SK125	G3801250		A5
Q 2006	FET				2SK125	G3801250		A4
Q 2007	FET				2SK125	G3801250		A3
Q 2008	FET				2SK125	G3801250		A3
Q 2009	FET				2SK125	G3801250		A3
Q 2010	FET				2SK125	G3801250		A3
Q 2011	TRANSISTOR				2SC2053	G3320530		A4
Q 2014	FET				3SK131-T2B V11	G4801317A		b5
Q 2015	TRANSISTOR				2SC2714YTE85R	G3327147Y		d5
Q 2016	FET				2SK302Y TE85R	G3803027Y		b5

RF Unit

REF.	DESCRIPTION	VALUE	WV	TOL.	MFGR'S DESIG	YAESU P/N	VERS.	Addr
Q 2017	FET				2SK302Y TE85R	G3803027Y		b5
Q 2018	TRANSISTOR				2SC2714YTE85R	G3327147Y		c3
Q 2019	TRANSISTOR				2SC2714YTE85R	G3327147Y		c3
Q 2020	IC				UPC1037H	G1090101		D4
Q 2021	FET				3SK131-T2B V11	G4801317A		d3
Q 2022	FET				3SK131-T2B V11	G4801317A		d2
Q 2031	IC				M5223FP-72A	G1090990		b3
Q 2032	IC				UPD4011BG-T2	G1091026		c3
Q 2033	FET				3SK131-T2B V11	G4801317A		d2
Q 2035	TRANSISTOR				2SC2712GR TE85R	G3327127G		b5
Q 2036	FET				3SK131-T2B V11	G4801317A		c5
Q 2037	TRANSISTOR				2SC2712GR TE85R	G3327127G		b5
Q 2038	FET				3SK131-T2B V11	G4801317A		b5
Q 2040	FET				2SK302Y TE85R	G3803027Y		d5
Q 2041	IC				MC3372ML	G1091108		c4
Q 2042	TRANSISTOR				FA1A4P-T2B	G3070006		c3
Q 2043	TRANSISTOR				2SC2712GR TE85R	G3327127G		d2
Q 2044	TRANSISTOR				2SC2712GR TE85R	G3327127G		d1
Q 2045	TRANSISTOR				2SC2712GR TE85R	G3327127G		d1
Q 2046	TRANSISTOR				FA1A4P-T2B	G3070006		c1
Q 2047	FET				2SK160-T2B K6	G3801607F		c1
Q 2048	FET				2SK302Y TE85R	G3803027Y		b4
Q 2049	FET				2SK302Y TE85R	G3803027Y		b5
Q 2050	FET				3SK131-T2B V11	G4801317A		c5
Q 2051	TRANSISTOR				2SC1973	G3319730		C6
Q 2053	TRANSISTOR				2SC2026	G3320260		C5
Q 2054	TRANSISTOR				2SC2712GR TE85R	G3327127G		c3
Q 2055	TRANSISTOR				FA1A4P-T2B	G3070006		c1
Q 2056	FET				3SK131-T2B V11	G4801317A		a6
Q 2058	TRANSISTOR				2SC2714YTE85R	G3327147Y		b4
Q 2059	TRANSISTOR				2SC2714YTE85R	G3327147Y		b4
Q 2060	TRANSISTOR				FN1A4P-T2B	G3070011		b4
Q 2061	TRANSISTOR				FA1A4P-T2B	G3070006		a1
Q 2062	IC				SN74LS145N	G1090395		C6
Q 2063	IC				IR3M03N2	G1091300		c2
Q 2064	TRANSISTOR				FA1A4P-T2B	G3070006		c5
Q 2065	TRANSISTOR				FA1A4P-T2B	G3070006		c4
Q 2066	TRANSISTOR				FA1A4P-T2B	G3070006		d4
Q 2067	IC				TC4S81F TE85R	G1090895		c4
Q 2068	IC				TC4S81F TE85R	G1090895		c4
Q 2069	TRANSISTOR				FA1A4P-T2B	G3070006		c4
Q 2070	TRANSISTOR				FN1A4P-T2B	G3070011		c4
Q 2071	TRANSISTOR				FA1A4P-T2B	G3070006		c4
Q 2072	TRANSISTOR				FN1A4P-T2B	G3070011		b3
R 2001	CHIP RES.	220		1/10W	RMC1/10T 221J	J24205221		
R 2002	CHIP RES.	390		1/10W	RMC1/10T 391J	J24205391		
R 2003	CHIP RES.	150		1/10W	RMC1/10T 151J	J24205151		
R 2004	CHIP RES.	68		1/10W	RMC1/10T 680J	J24205680		
R 2005	CHIP RES.	180		1/10W	RMC1/10T 181J	J24205181		
R 2006	CARBON FILM RES.	180		1/4W	RD14SJ181	J02245181		
R 2007	CHIP RES.	10		1/10W	RMC1/10T 100J	J24205100		
R 2008	CHIP RES.	10		1/10W	RMC1/10T 100J	J24205100		
R 2009	CHIP RES.	10		1/10W	RMC1/10T 100J	J24205100		
R 2010	CHIP RES.	10		1/10W	RMC1/10T 100J	J24205100		
R 2011	CHIP RES.	10		1/10W	RMC1/10T 100J	J24205100		

REF.	DESCRIPTION	VALUE	WV	TOL.	MFRG'S DESIG	YAESU P/N	VERS.	Addr
R 2012	CHIP RES.	10	1/10W		RMC1/10T 100J	J24205100		
R 2013	CHIP RES.	10	1/10W		RMC1/10T 100J	J24205100		
R 2014	CHIP RES.	10	1/10W		RMC1/10T 100J	J24205100		
R 2015	CHIP RES.	100	1/10W		RMC1/10T 101J	J24205101		
R 2016	CHIP RES.	100	1/10W		RMC1/10T 101J	J24205101		
R 2017	CHIP RES.	100	1/10W		RMC1/10T 101J	J24205101		
R 2018	CHIP RES.	100	1/10W		RMC1/10T 101J	J24205101		
R 2019	CHIP RES.	100	1/10W		RMC1/10T 101J	J24205101		
R 2020	CHIP RES.	100	1/10W		RMC1/10T 101J	J24205101		
R 2021	CHIP RES.	100	1/10W		RMC1/10T 101J	J24205101		
R 2023	CARBON FILM RES.	220	1/4W		RD14SJ221	J02245221		
R 2024	CHIP RES.	68	1/10W		RMC1/10T 680J	J24205680		
R 2025	CARBON FILM RES.	330	1/6W		RD16TPJ331	J07225331		
R 2028	CHIP RES.	15	1/10W		RMC1/10T 150J	J24205150		
R 2029	CHIP RES.	470	1/10W		RMC1/10T 471J	J24205471		
R 2030	CHIP RES.	100	1/10W		RMC1/10T 101J	J24205101		
R 2031	CHIP RES.	680	1/10W		RMC1/10T 681J	J24205681		
R 2032	CHIP RES.	680	1/10W		RMC1/10T 681J	J24205681		
R 2033	CHIP RES.	680	1/10W		RMC1/10T 681J	J24205681		
R 2034	CHIP RES.	680	1/10W		RMC1/10T 681J	J24205681		
R 2035	CHIP RES.	15K	1/10W		RMC1/10T 153J	J24205153		
R 2036	CHIP RES.	15	1/10W		RMC1/10T 150J	J24205150		
R 2037	CHIP RES.	100K	1/10W		RMC1/10T 104J	J24205104		
R 2038	CHIP RES.	68K	1/10W		RMC1/10T 683J	J24205683		
R 2041	CARBON FILM RES.	4.7	1/4W		RD14SJ4R7	J02245479		
R 2042	CARBON FILM RES.	100	1/4W		RD14SJ101	J02245101		
R 2043	CHIP RES.	680	1/10W		RMC1/10T 681J	J24205681		
R 2044	CHIP RES.	15K	1/10W		RMC1/10T 153J	J24205153		
R 2045	CHIP RES.	470	1/10W		RMC1/10T 471J	J24205471		
R 2046	CHIP RES.	68K	1/10W		RMC1/10T 683J	J24205683		
R 2047	CHIP RES.	22K	1/10W		RMC1/10T 223J	J24205223		
R 2049	CHIP RES.	220	1/10W		RMC1/10T 221J	J24205221		
R 2050	CHIP RES.	10	1/10W		RMC1/10T 100J	J24205100		
R 2052	CHIP RES.	10K	1/10W		RMC1/10T 103J	J24205103		
R 2053	CHIP RES.	220	1/10W		RMC1/10T 221J	J24205221		
R 2057	CHIP RES.	470K	1/10W		RMC1/10T 474J	J24205474		
R 2058	CHIP RES.	100	1/10W		RMC1/10T 101J	J24205101		
R 2059	CHIP RES.	220	1/10W		RMC1/10T 221J	J24205221		
R 2060	CHIP RES.	330	1/10W		RMC1/10T 331J	J24205331		
R 2061	CHIP RES.	390	1/10W		RMC1/10T 391J	J24205391		
R 2064	CHIP RES.	10K	1/10W		RMC1/10T 103J	J24205103		
R 2065	CHIP RES.	22K	1/10W		RMC1/10T 223J	J24205223		
R 2066	CHIP RES.	150	1/10W		RMC1/10T 151J	J24205151		
R 2067	CHIP RES.	470	1/10W		RMC1/10T 471J	J24205471		
R 2068	CHIP RES.	470	1/10W		RMC1/10T 471J	J24205471		
R 2069	CHIP RES.	1K	1/10W		RMC1/10T 102J	J24205102		
R 2070	CHIP RES.	470	1/10W		RMC1/10T 471J	J24205471		
R 2071	CHIP RES.	470	1/10W		RMC1/10T 471J	J24205471		
R 2072	CHIP RES.	100	1/10W		RMC1/10T 101J	J24205101		
R 2073	CHIP RES.	100K	1/10W		RMC1/10T 104J	J24205104		
R 2074	CHIP RES.	100K	1/10W		RMC1/10T 104J	J24205104		
R 2075	CHIP RES.	100K	1/10W		RMC1/10T 104J	J24205104		
R 2076	CHIP RES.	100	1/10W		RMC1/10T 101J	J24205101		
R 2077	CHIP RES.	10K	1/10W		RMC1/10T 103J	J24205103		
R 2078	CHIP RES.	22K	1/10W		RMC1/10T 223J	J24205223		
R 2079	CHIP RES.	10K	1/10W		RMC1/10T 103J	J24205103		

RF Unit

REF.	DESCRIPTION	VALUE	WV	TOL.	MFR'S DESIG	YAESU P/N	VERS.	Addr
R 2080	CHIP RES.	1K	1/10W		RMC1/10T 102J	J24205102		
R 2081	CHIP RES.	4. 7K	1/10W		RMC1/10T 472J	J24205472		
R 2082	CHIP RES.	22K	1/10W		RMC1/10T 223J	J24205223		
R 2083	CHIP RES.	10K	1/10W		RMC1/10T 103J	J24205103		
R 2084	CHIP RES.	330	1/10W		RMC1/10T 331J	J24205331		
R 2086	CHIP RES.	1K	1/10W		RMC1/10T 102J	J24205102		
R 2088	CHIP RES.	220	1/10W		RMC1/10T 221J	J24205221		
R 2090	CHIP RES.	220	1/10W		RMC1/10T 221J	J24205221		
R 2091	CHIP RES.	390	1/10W		RMC1/10T 391J	J24205391		
R 2092	CHIP RES.	3. 3K	1/10W		RMC1/10T 332J	J24205332		
R 2093	CHIP RES.	68K	1/10W		RMC1/10T 683J	J24205683		
R 2094	CHIP RES.	1K	1/10W		RMC1/10T 102J	J24205102		
R 2095	CHIP RES.	47K	1/10W		RMC1/10T 473J	J24205473		
R 2096	CHIP RES.	390	1/10W		RMC1/10T 391J	J24205391		
R 2097	CHIP RES.	220	1/10W		RMC1/10T 221J	J24205221		
R 2100	CHIP RES.	100	1/10W		RMC1/10T 101J	J24205101		
R 2101	CHIP RES.	47K	1/10W		RMC1/10T 473J	J24205473		
R 2102	CHIP RES.	47K	1/10W		RMC1/10T 473J	J24205473		
R 2103	CHIP RES.	2. 2K	1/10W		RMC1/10T 222J	J24205222		
R 2104	CHIP RES.	15K	1/10W		RMC1/10T 153J	J24205153		
R 2105	CHIP RES.	100	1/10W		RMC1/10T 101J	J24205101		
R 2106	CHIP RES.	100	1/10W		RMC1/10T 101J	J24205101		
R 2107	CHIP RES.	1K	1/10W		RMC1/10T 102J	J24205102		
R 2108	CHIP RES.	1K	1/10W		RMC1/10T 102J	J24205102		
R 2109	CHIP RES.	10K	1/10W		RMC1/10T 103J	J24205103		
R 2110	CHIP RES.	4. 7K	1/10W		RMC1/10T 472J	J24205472		
R 2111	CHIP RES.	100	1/10W		RMC1/10T 101J	J24205101		
R 2112	CHIP RES.	100	1/10W		RMC1/10T 101J	J24205101		
R 2113	CHIP RES.	0	1/10W		RMC1/10T 000J	J24205000		
R 2119	CHIP RES.	100	1/10W		RMC1/10T 101J	J24205101		
R 2120	CHIP RES.	47K	1/10W		RMC1/10T 473J	J24205473		
R 2121	CHIP RES.	15K	1/10W		RMC1/10T 153J	J24205153		
R 2122	CHIP RES.	22K	1/10W		RMC1/10T 223J	J24205223		
R 2123	CHIP RES.	330	1/10W		RMC1/10T 331J	J24205331		
R 2124	CHIP RES.	47K	1/10W		RMC1/10T 473J	J24205473		
R 2125	CHIP RES.	470K	1/10W		RMC1/10T 474J	J24205474		
R 2126	CHIP RES.	100	1/10W		RMC1/10T 101J	J24205101		
R 2127	CHIP RES.	15K	1/10W		RMC1/10T 153J	J24205153		
R 2128	CHIP RES.	47K	1/10W		RMC1/10T 473J	J24205473		
R 2129	CHIP RES.	2. 2K	1/10W		RMC1/10T 222J	J24205222		
R 2130	CHIP RES.	10	1/10W		RMC1/10T 100J	J24205100		
R 2131	CHIP RES.	15K	1/10W		RMC1/10T 153J	J24205153		
R 2132	CHIP RES.	100	1/10W		RMC1/10T 101J	J24205101		
R 2133	CHIP RES.	220	1/10W		RMC1/10T 221J	J24205221		
R 2134	CHIP RES.	22K	1/10W		RMC1/10T 223J	J24205223		
R 2135	CHIP RES.	100	1/10W		RMC1/10T 101J	J24205101		
R 2136	CHIP RES.	1K	1/10W		RMC1/10T 102J	J24205102		
R 2137	CHIP RES.	100	1/10W		RMC1/10T 101J	J24205101		
R 2138	CHIP RES.	100	1/10W		RMC1/10T 101J	J24205101		
R 2139	CHIP RES.	100	1/10W		RMC1/10T 101J	J24205101		
R 2140	CHIP RES.	4. 7K	1/10W		RMC1/10T 472J	J24205472		
R 2141	CHIP RES.	4. 7K	1/10W		RMC1/10T 472J	J24205472		
R 2142	CHIP RES.	4. 7K	1/10W		RMC1/10T 472J	J24205472		
R 2143	CHIP RES.	100	1/10W		RMC1/10T 101J	J24205101		
R 2144	CHIP RES.	100	1/10W		RMC1/10T 101J	J24205101		
R 2145	CHIP RES.	100	1/10W		RMC1/10T 101J	J24205101		

REF.	DESCRIPTION	VALUE	WV	TOL.	MFGR'S DESIG	YAESU P/N	VERS.	Addr
R 2146	CHIP RES.	3. 3K	1/10W		RMC1/10T 332J	J24205332		
R 2147	CHIP RES.	4. 7K	1/10W		RMC1/10T 472J	J24205472		
R 2148	CHIP RES.	4. 7K	1/10W		RMC1/10T 472J	J24205472		
R 2149	CHIP RES.	10K	1/10W		RMC1/10T 103J	J24205103		
R 2150	CHIP RES.	100K	1/10W		RMC1/10T 104J	J24205104		
R 2151	CHIP RES.	1K	1/10W		RMC1/10T 102J	J24205102		
R 2152	CHIP RES.	2. 2K	1/10W		RMC1/10T 222J	J24205222		
R 2153	CHIP RES.	150K	1/10W		RMC1/10T 154J	J24205154		
R 2154	CHIP RES.	10K	1/10W		RMC1/10T 103J	J24205103		
R 2155	CHIP RES.	1K	1/10W		RMC1/10T 102J	J24205102		
R 2156	CHIP RES.	2. 2K	1/10W		RMC1/10T 222J	J24205222		
R 2157	CHIP RES.	470K	1/10W		RMC1/10T 474J	J24205474		
R 2158	CHIP RES.	47K	1/10W		RMC1/10T 473J	J24205473		
R 2159	CHIP RES.	4. 7K	1/10W		RMC1/10T 472J	J24205472		
R 2160	CHIP RES.	15K	1/10W		RMC1/10T 153J	J24205153		
R 2161	CHIP RES.	1. 5K	1/10W		RMC1/10T 152J	J24205152		
R 2162	CHIP RES.	47K	1/10W		RMC1/10T 473J	J24205473		
R 2163	CHIP RES.	1. 5K	1/10W		RMC1/10T 152J	J24205152		
R 2164	CHIP RES.	100	1/10W		RMC1/10T 101J	J24205101		
R 2165	CHIP RES.	820	1/10W		RMC1/10T 821J	J24205821		
R 2166	CHIP RES.	6. 8K	1/10W		RMC1/10T 682J	J24205682		
R 2169	CHIP RES.	100	1/10W		RMC1/10T 101J	J24205101		
R 2170	CHIP RES.	4. 7K	1/10W		RMC1/10T 472J	J24205472		
R 2171	CHIP RES.	4. 7K	1/10W		RMC1/10T 472J	J24205472		
R 2172	CHIP RES.	2. 2M	1/10W		RMC1/10T 225J	J24205225		
R 2173	CHIP RES.	100K	1/10W		RMC1/10T 104J	J24205104		
R 2174	CHIP RES.	1K	1/10W		RMC1/10T 102J	J24205102		
R 2175	CHIP RES.	1K	1/10W		RMC1/10T 102J	J24205102		
R 2176	CHIP RES.	100	1/10W		RMC1/10T 101J	J24205101		
R 2177	CHIP RES.	2. 2K	1/10W		RMC1/10T 222J	J24205222		
R 2178	CHIP RES.	4. 7K	1/10W		RMC1/10T 472J	J24205472		
R 2179	CHIP RES.	1. 5M	1/10W		RMC1/10T 155J	J24205155		
R 2180	CHIP RES.	4. 7K	1/10W		RMC1/10T 472J	J24205472		
R 2181	CHIP RES.	220	1/10W		RMC1/10T 221J	J24205221		
R 2182	CHIP RES.	68K	1/10W		RMC1/10T 683J	J24205683		
R 2183	CHIP RES.	100K	1/10W		RMC1/10T 104J	J24205104		
R 2184	CHIP RES.	100K	1/10W		RMC1/10T 104J	J24205104		
R 2185	CHIP RES.	100K	1/10W		RMC1/10T 104J	J24205104		
R 2186	CHIP RES.	100K	1/10W		RMC1/10T 104J	J24205104		
R 2187	CHIP RES.	330K	1/10W		RMC1/10T 334J	J24205334		
R 2188	CHIP RES.	22K	1/10W		RMC1/10T 223J	J24205223		
R 2189	CHIP RES.	150K	1/10W		RMC1/10T 154J	J24205154		
R 2190	CHIP RES.	10K	1/10W		RMC1/10T 103J	J24205103		
R 2191	CHIP RES.	1K	1/10W		RMC1/10T 102J	J24205102		
R 2192	CHIP RES.	10K	1/10W		RMC1/10T 103J	J24205103		
R 2193	CHIP RES.	15K	1/10W		RMC1/10T 153J	J24205153		
R 2195	CHIP RES.	220	1/10W		RMC1/10T 221J	J24205221		
R 2196	CHIP RES.	100	1/10W		RMC1/10T 101J	J24205101		
R 2197	CHIP RES.	120K	1/10W		RMC1/10T 124J	J24205124		
R 2198	CHIP RES.	68K	1/10W		RMC1/10T 683J	J24205683		
R 2201	CHIP RES.	100	1/10W		RMC1/10T 101J	J24205101		
R 2202	CHIP RES.	1K	1/10W		RMC1/10T 102J	J24205102		
R 2203	CHIP RES.	100	1/10W		RMC1/10T 101J	J24205101		
R 2204	CHIP RES.	1K	1/10W		RMC1/10T 102J	J24205102		
R 2205	CHIP RES.	47K	1/10W		RMC1/10T 473J	J24205473		
R 2206	CHIP RES.	10K	1/10W		RMC1/10T 103J	J24205103		

RF Unit

REF.	DESCRIPTION	VALUE	WV	TOL.	MFR'S DESIG	YAESU P/N	VERS.	Addr
R 2207	CHIP RES.	220	1/10W		RMC1/10T 221J	J24205221		
R 2210	CHIP RES.	1K	1/10W		RMC1/10T 102J	J24205102		
R 2212	CARBON FILM RES.	100	1/2W		RD12TJ101	J01275101		
R 2215	CHIP RES.	47	1/10W		RMC1/10T 470J	J24205470		
R 2216	CHIP RES.	3.3K	1/10W		RMC1/10T 332J	J24205332		
R 2217	CHIP RES.	4.7K	1/10W		RMC1/10T 472J	J24205472		
R 2218	CHIP RES.	470	1/10W		RMC1/10T 471J	J24205471		
R 2219	CHIP RES.	150	1/10W		RMC1/10T 151J	J24205151		
R 2220	CHIP RES.	1K	1/10W		RMC1/10T 102J	J24205102		
R 2221	CHIP RES.	47K	1/10W		RMC1/10T 473J	J24205473		
R 2222	CHIP RES.	1K	1/10W		RMC1/10T 102J	J24205102		
R 2223	CHIP RES.	1K	1/10W		RMC1/10T 102J	J24205102		
R 2228	CHIP RES.	10K	1/10W		RMC1/10T 103J	J24205103		
R 2232	CHIP RES.	10	1/10W		RMC1/10T 100J	J24205100		
R 2234	CHIP RES.	100	1/10W		RMC1/10T 101J	J24205101		
R 2235	CHIP RES.	10	1/10W		RMC1/10T 100J	J24205100		
R 2236	CHIP RES.	270	1/10W		RMC1/10T 271J	J24205271		
R 2237	CHIP RES.	1K	1/10W		RMC1/10T 102J	J24205102		
R 2238	CHIP RES.	56	1/10W		RMC1/10T 560J	J24205560		
R 2239	CHIP RES.	47K	1/10W		RMC1/10T 473J	J24205473		
R 2240	CHIP RES.	15K	1/10W		RMC1/10T 153J	J24205153		
R 2241	CHIP RES.	220	1/10W		RMC1/10T 221J	J24205221		
R 2247	CHIP RES.	10K	1/10W		RMC1/10T 103J	J24205103		
R 2248	CHIP RES.	100	1/10W		RMC1/10T 101J	J24205101		
R 2249	CHIP RES.	470	1/10W		RMC1/10T 471J	J24205471		
R 2250	CHIP RES.	0	1/10W		RMC1/10T 000J	J24205000		
R 2251	CHIP RES.	100	1/10W		RMC1/10T 101J	J24205101		
R 2252	CHIP RES.	470	1/10W		RMC1/10T 471J	J24205471		
R 2253	CHIP RES.	100K	1/10W		RMC1/10T 104J	J24205104		
R 2256	CHIP RES.	470	1/10W		RMC1/10T 471J	J24205471		
R 2257	CHIP RES.	12K	1/10W		RMC1/10T 123J	J24205123		
R 2258	CHIP RES.	15K	1/10W		RMC1/10T 153J	J24205153		
R 2259	CHIP RES.	100	1/10W		RMC1/10T 101J	J24205101		
R 2260	CHIP RES.	3.9K	1/10W		RMC1/10T 392J	J24205392		
R 2261	CHIP RES.	100K	1/10W		RMC1/10T 104J	J24205104		
R 2262	CHIP RES.	100K	1/10W		RMC1/10T 104J	J24205104		
R 2263	CHIP RES.	100K	1/10W		RMC1/10T 104J	J24205104		
R 2269	CHIP RES.	1K	1/10W		RMC1/10T 102J	J24205102		
R 2270	CHIP RES.	1K	1/10W		RMC1/10T 102J	J24205102		
R 2271	CHIP RES.	1K	1/10W		RMC1/10T 102J	J24205102		
R 2272	CHIP RES.	1K	1/10W		RMC1/10T 102J	J24205102		
R 2273	CARBON FILM RES.	1	1/4W		RD14SJ1R0	J02245010		
R 2274	CARBON FILM RES.	1	1/4W		RD14SJ1R0	J02245010		
R 2275	METAL FILM RES.	8.87K	1/4W	1%	MRS25F 8.87K	J20249046		
R 2276	METAL FILM RES.	1.43K	1/4W		MRS25F 1.43K	J20249102		
R 2277	CHIP RES.	3.3K	1/10W		RMC1/10T 332J	J24205332		
R 2278	CHIP RES.	3.3K	1/10W		RMC1/10T 332J	J24205332		
R 2279	CHIP RES.	22K	1/10W		RMC1/10T 223J	J24205223		
R 2280	CHIP RES.	22K	1/10W		RMC1/10T 223J	J24205223		
R 2281	CHIP RES.	22K	1/10W		RMC1/10T 223J	J24205223		
R 2282	CHIP RES.	22K	1/10W		RMC1/10T 223J	J24205223		
R 2283	CHIP RES.	22K	1/10W		RMC1/10T 223J	J24205223		
R 2284	CHIP RES.	22K	1/10W		RMC1/10T 223J	J24205223		
R 2285	CHIP RES.	22K	1/10W		RMC1/10T 223J	J24205223		
R 2286	CHIP RES.	22K	1/10W		RMC1/10T 223J	J24205223		
R 2287	CHIP RES.	3.3K	1/10W		RMC1/10T 332J	J24205332		

REF.	DESCRIPTION	VALUE	WV	TOL.	MFGR'S DESIG	YAESU P/N	VERS.	Addr
R 2291	CHIP RES.	1K	1/10W		RMC1/10T 102J	J24205102		
R 2292	CHIP RES.	2.2K	1/10W		RMC1/10T 222J	J24205222		
R 2293	CHIP RES.	2.2K	1/10W		RMC1/10T 222J	J24205222		
R 2296	CHIP RES.	0	1/10W		RMC1/10T 000J	J24205000		
R 2297	CHIP RES.	0	1/10W		RMC1/10T 000J	J24205000		
R 2298	CHIP RES.	2.2K	1/10W		RMC1/10T 222J	J24205222		
R 2299	CHIP RES.	1K	1/10W		RMC1/10T 102J	J24205102		
R 2300	CHIP RES.	0	1/10W		RMC1/10T 000J	J24205000		
R 2301	CHIP RES.	0	1/10W		RMC1/10T 000J	J24205000		
R 2302	CHIP RES.	1.5K	1/10W		RMC1/10T 152J	J24205152		
R 2303	CHIP RES.	4.7K	1/10W		RMC1/10T 472J	J24205472		
R 2304	CHIP RES.	47K	1/10W		RMC1/10T 473J	J24205473		
R 2305	CHIP RES.	10K	1/10W		RMC1/10T 103J	J24205103		
R 2306	CHIP RES.	6.8K	1/10W		RMC1/10T 682J	J24205682		
R 2307	CHIP RES.	22K	1/10W		RMC1/10T 223J	J24205223		
R 2308	CARBON FILM RES.	220	1/6W		RD16TPJ221	J07225221		
R 2309	CARBON FILM RES.	390	1/6W		RD16TPJ391	J07225391		
R 2310	CARBON FILM RES.	180	1/6W		RD16TPJ181	J07225181		
R 2311	CHIP RES.	10K	1/10W		RMC1/10T 103J	J24205103		
R 2312	CHIP RES.	4.7K	1/10W		RMC1/10T 472J	J24205472		
R 2313	CHIP RES.	0	1/10W		RMC1/10T 000J	J24205000		
R 2315	CHIP RES.	2.2K	1/10W		RMC1/10T 222J	J24205222		
R 2316	CHIP RES.	10	1/10W		RMC1/10T 100J	J24205100		
R 2317	CHIP RES.	100	1/10W		RMC1/10T 101J	J24205101		
R 2318	CHIP RES.	150	1/10W		RMC1/10T 151J	J24205151		
R 2319	CARBON FILM RES.	100	1/6W		RD16TPJ101	J07225101		
R 2320	CHIP RES.	56	1/10W		RMC1/10T 560J	J24205560		
R 2321	CHIP RES.	1K	1/10W		RMC1/10T 102J	J24205102		
R 2322	CHIP RES.	220	1/10W		RMC1/10T 221J	J24205221		
R 2323	CHIP RES.	10K	1/10W		RMC1/10T 103J	J24205103		
R 2324	CHIP RES.	2.2K	1/10W		RMC1/10T 222J	J24205222		
R 2325	CHIP RES.	1K	1/10W		RMC1/10T 102J	J24205102		
R 2326	CHIP RES.	180	1/10W		RMC1/10T 181J	J24205181		
R 2327	CHIP RES.	330	1/10W		RMC1/10T 331J	J24205331		
R 2328	CHIP RES.	120	1/10W		RMC1/10T 121J	J24205121		
R 2329	CHIP RES.	0	1/10W		RMC1/10T 000J	J24205000		
R 2330	CHIP RES.	10K	1/10W		RMC1/10T 103J	J24205103		
R 2331	CHIP RES.	100K	1/10W		RMC1/10T 104J	J24205104		
R 2332	CARBON FILM RES.	4.7K	1/6W		RD16TPJ472	J07225472		
R 2333	CARBON FILM RES.	1K	1/6W		RD16TPJ102	J07225102		
R 2904	CHIP RES.	0	1/10W		RMC1/10T 000J	J24205000		
R 2905	CHIP RES.	0	1/10W		RMC1/10T 000J	J24205000		
R 2908	CHIP RES.	0	1/10W		RMC1/10T 000J	J24205000		
R 2909	CHIP RES.	0	1/10W		RMC1/10T 000J	J24205000		
R 2910	CHIP RES.	0	1/10W		RMC1/10T 000J	J24205000		
RL2001	RELAY		DC12V		AG2013	M1190045		
RL2002	RELAY		DC12V		AG4013	M1190090		
S 2001	SLIDE SWITCH				SS912L4NS	N6090066		
T 2001	COIL				4-1 2001F FR6	L0021351		
T 2002	COIL				4-1 2001F FR6	L0021351		
T 2003	COIL				- 2001F	L0021973		
T 2004	COIL				4-1 2D3 TR6X3	L0020788A		
T 2005	COIL				73.62M R12-J757A	L0021957		

RF Unit

REF.	DESCRIPTION	VALUE	WV	TOL.	MFGR'S DESIG	YAESU P/N	VERS.	Addr
T 2006	07 WIDE TRANS				4-1 3A	L0021462		
T 2009	COIL				73.62M S-135-214	L0021960		
T 2010	COIL				73.62M S-135-214	L0021960		
T 2011	COIL				73.62M S-135-214	L0021960		
T 2012	COIL				73.62M R12-J757A	L0021957		
T 2013	07 WIDE TRANS				4-1 3A	L0021462		
T 2014	COIL				455K	L0020860		
T 2015	COIL				R12-7947C	L0020422		
T 2016	COIL				455K R12-5898C	L0190026		
T 2017	COIL				455K R12-5898C	L0190026		
T 2018	COIL				R12-7947C	L0020422		
T 2019	COIL				8.20M R12-4043A	L0021199		
T 2020	COIL				R12-7947C	L0020422		
T 2021	COIL				R12-7947C	L0020422		
T 2022	COIL				R12-7943B	L0020420		
T 2023	COIL				R12-7935A	L0020421		
T 2024	COIL				R12-7947C	L0020422		
T 2025	COIL				R12-7947C	L0020422		
T 2026	COIL				R12-7943B	L0020420		
T 2027	COIL				455K	L0020860		
T 2028	COIL				73.62M R12-J757A	L0021957		
T 2029	COIL				73.62M R12-J757A	L0021957		
T 2030	COIL				4-1 2D3 TR6X3	L0020788A		
T 2031	COIL				4-1 2D3 TR6X3	L0020788A		
T 2032	COIL				8.20M R12-4043A	L0021199		
TH2001	THERMISTOR				112252-2	G9090016		
TH2002	THERMISTOR				112252-2	G9090016		
TH2004	THERMISTOR				112302-2	G9090010		
TH2005	THERMISTOR				112501-2	G9090013		
TH2006	THERMISTOR				112501-2	G9090013		
TP2001	TP-F				TP-F IPS-1032	Q5000026		
TP2002	TP-F				TP-F IPS-1032	Q5000026		
TP2003	TP-F				TP-F IPS-1032	Q5000026		
TP2005	TP-F				TP-F IPS-1032	Q5000026		
VR2001	POT.	4.7KB			H0651A011-4.7KB	J51745472		
VR2002	POT.	4.7KB			H0651A011-4.7KB	J51745472		
VR2003	POT.	2.2KB			H0651A009-2.2KB	J51745222		
VR2004	POT.	2.2KB			H0651A009-2.2KB	J51745222		
VR2005	POT.	10KB			H0651A013-10KB	J51745103		
VR2006	POT.	1KB			H0651A007-1KB	J51745102		
VR2007	POT.	1KB			H0651A007-1KB	J51745102		
VR2008	POT.	100KB			H0651A019-100KB	J51745104		
VR2009	POT.	10KB			H0651A013-10KB	J51745103		
X 2001	XTAL	8.67MHZ			HC-18/U	H0102550		
X 2002	XTAL	70.455MHZ			HC-49/T	H0103010		
XF2001	XTAL				70R12BUF	H1102202		
XF2004	XTAL				8.2M20A	H1102050		

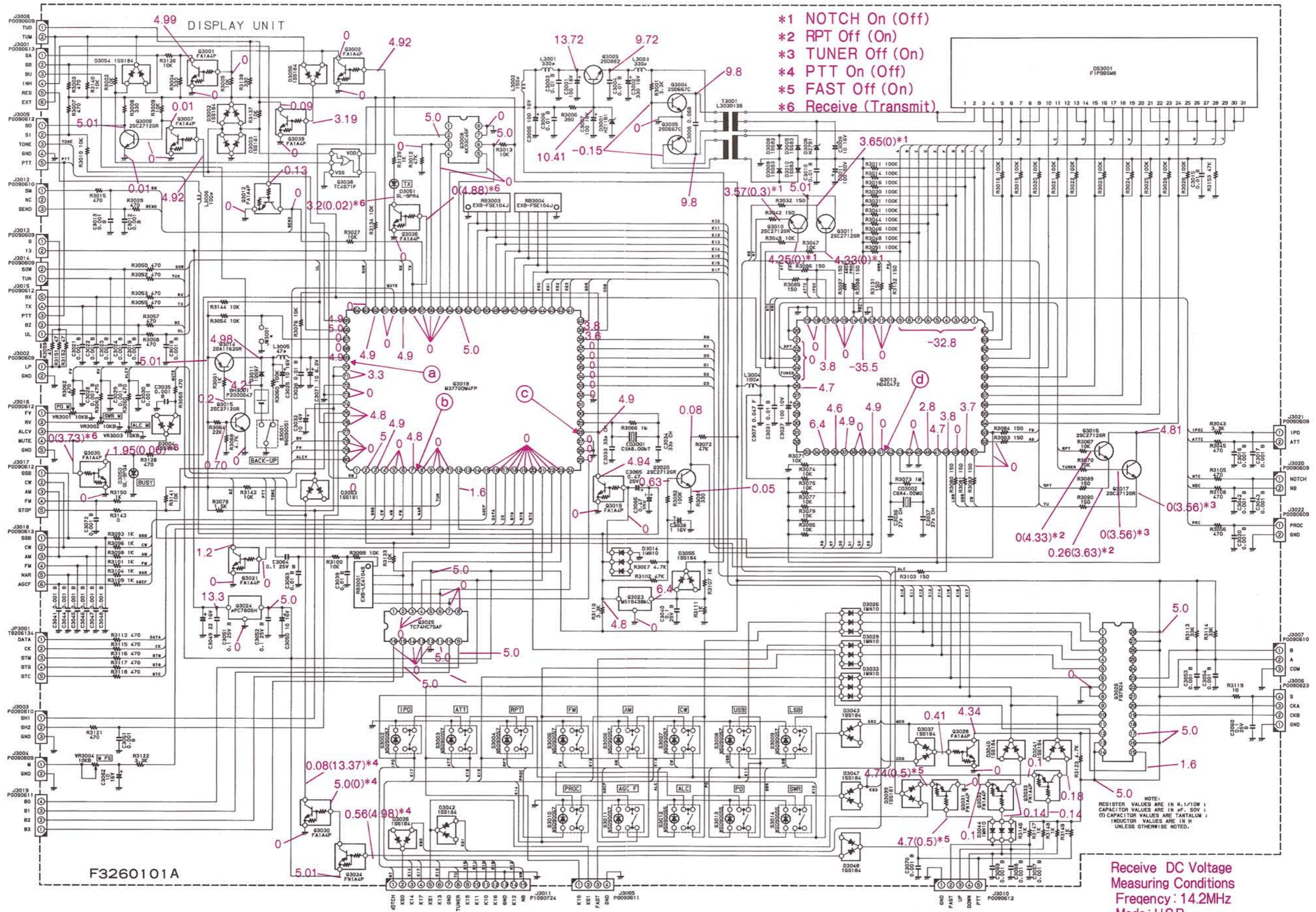

- *1 NOTCH On (Off)
- *2 RPT Off (On)
- *3 TUNER Off (On)
- *4 PTT On (Off)
- *5 FAST Off (On)
- *6 Receive (Transmit)

NOTE:
 RESISTOR VALUES ARE IN Ω, 1/10Ω;
 CAPACITOR VALUES ARE IN pF, 50V;
 (†) CAPACITOR VALUES ARE TANTALUM;
 INDUCTOR VALUES ARE IN μH
 UNLESS OTHERWISE NOTED.

Receive DC Voltage
 Measuring Conditions
 Frequency: 14.2MHz
 Mode: USB

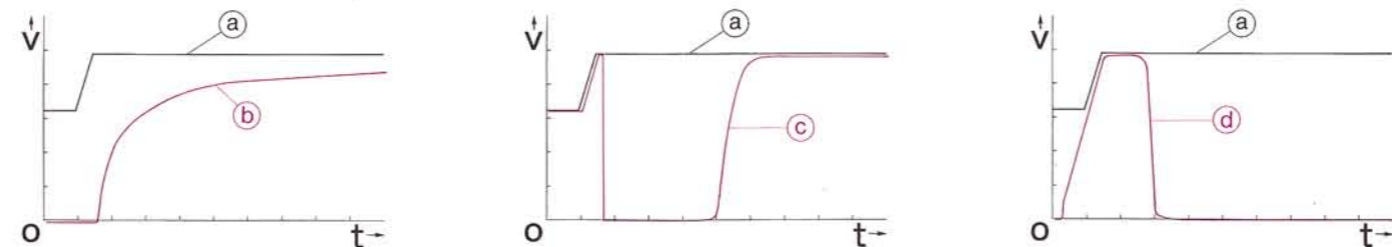

V: 1V/DIV
 t: 10msec/DIV

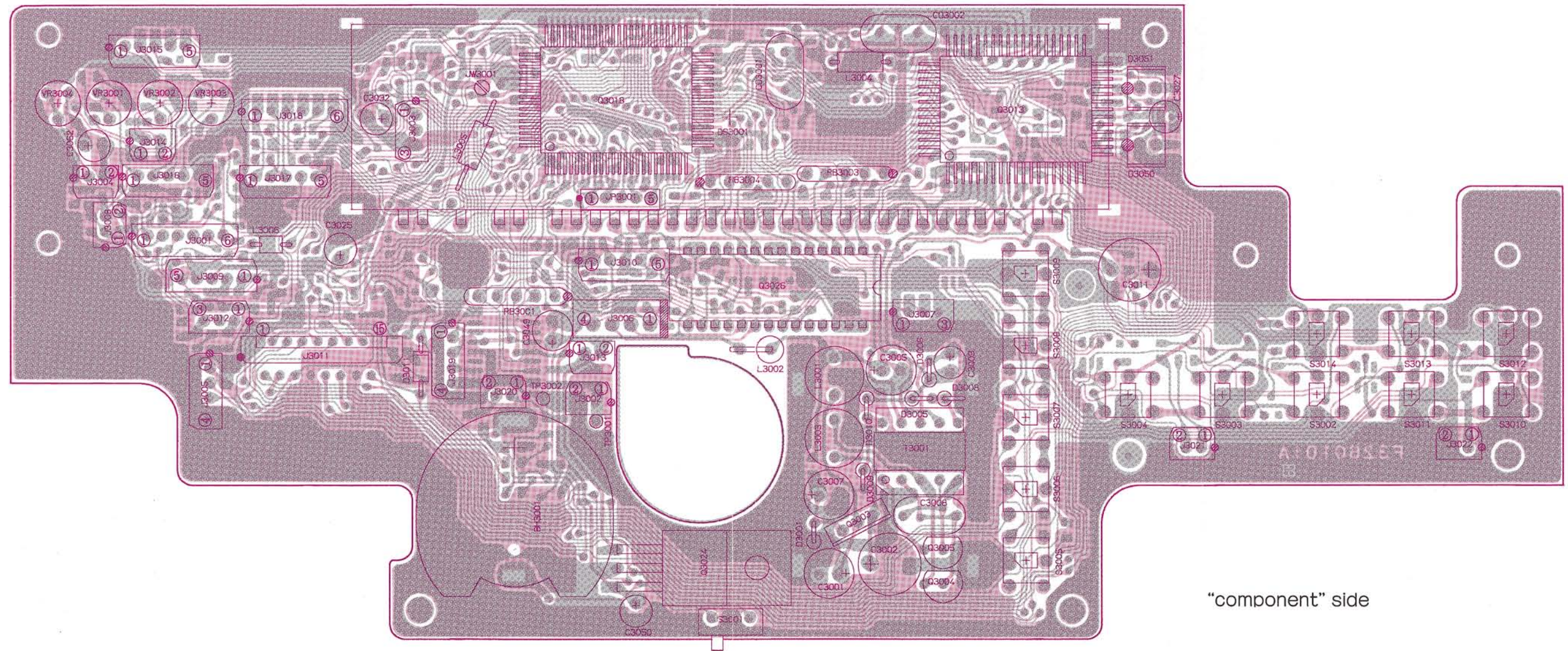

"component" side

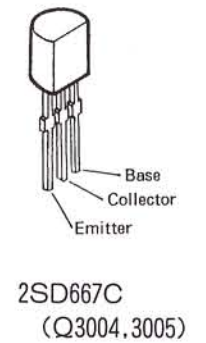
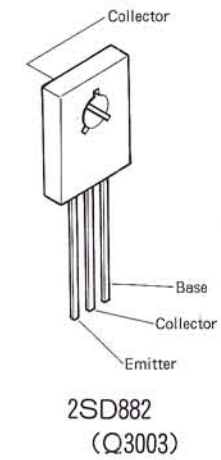
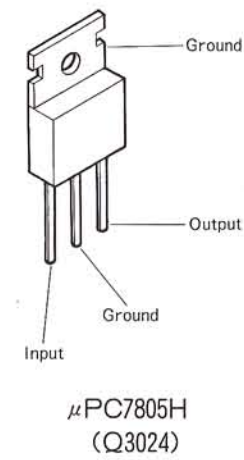
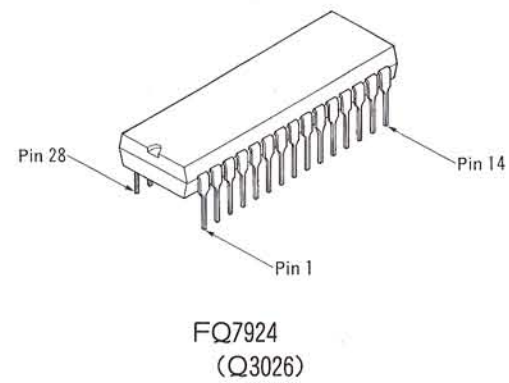
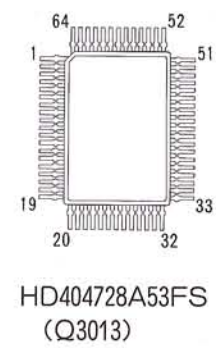
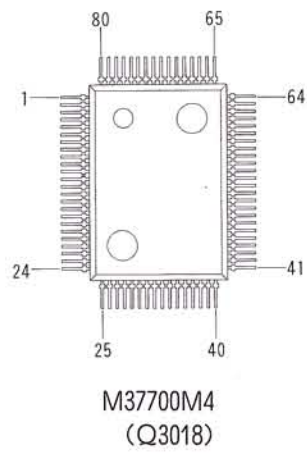

Display Unit

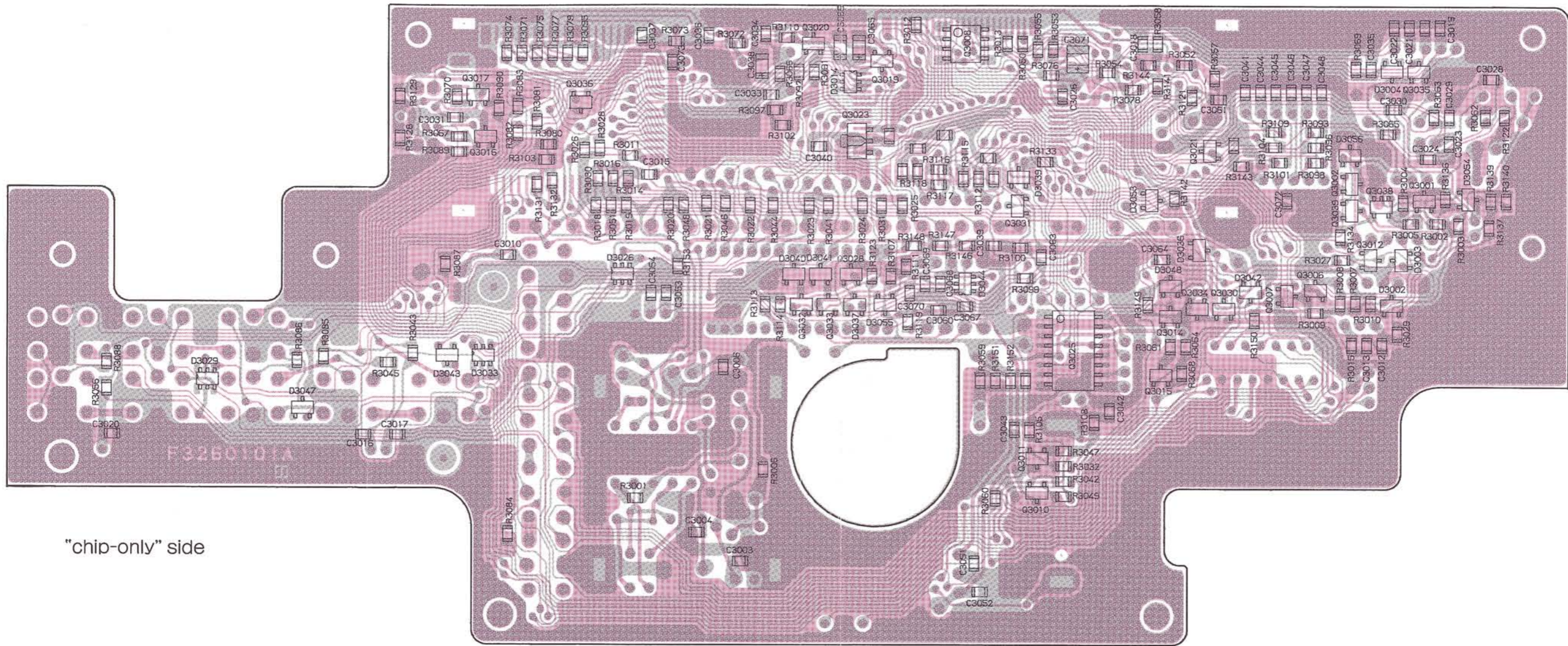

"chip-only" side

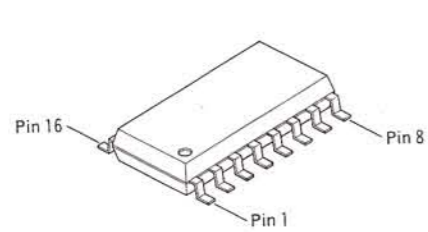

TC74HC75AF
(Q3025)

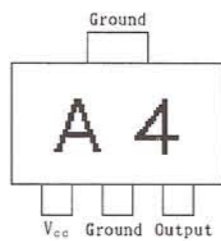

M51943BML (A4)
(Q3023)

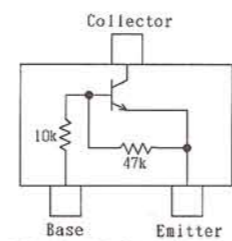

FA1A4P (L34)
(Q3001, 3002, 3007
3012, 3019, 3021
3028, 3030, 3035
3036, 3039)

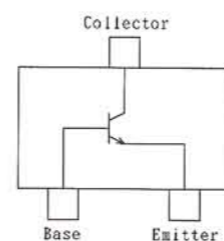

2SC2712GR (LG)
(Q3006, 3010, 3011
3015, 3016, 3017
3020)

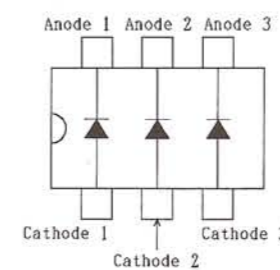

IMN10 (N10)
(D3014, 3026, 3029
3033, 3044)

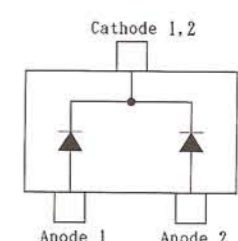

1SS184 (B3)
(D3002, 3004, 3036
3037, 3040, 3041
3042, 3043, 3047
3048, 3054, 3055
3056)

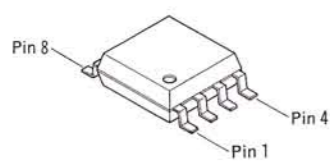

AK93C46F
(Q3008)

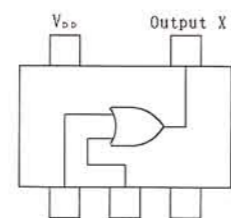

TC4S71F (C4)
(Q3038)

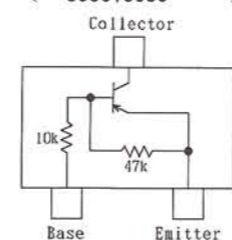

FN1A4P (M34)
(Q3031, 3032, 3033
3034)

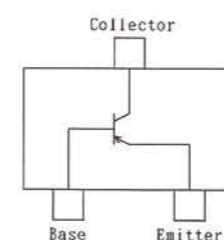

2SA1162GR (SG)
(Q3014)

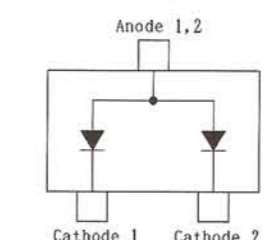

1SS181 (A3)
(D3003, 3039, 3053)

Display Unit

REF.	DESCRIPTION	VALUE	WV	TOL.	MFGR'S DESIG	YAESU P/N	VERS.	Addr
*** DISPLAY UNIT ***								
	PCB W COMP.					CA0388001		
	PCB W/O COMP.					F3260101A		
BH3001	BATTERY HOLDER				CR2032HOLDER	P2000047		
C 3001	AL. ELECTRO. CAP.	100uF	16V		16V101M6X7TR2	K46120007		
C 3002	AL. ELECTRO. CAP.	330uF	16V		16V331M8X11TR5	K46120002		
C 3003	CHIP CAP.	0.01uF	50V	B	GRM40B103M50PT	K22170817		
C 3004	CHIP CAP.	0.01uF	50V	B	GRM40B103M50PT	K22170817		
C 3005	AL. ELECTRO. CAP.	100uF	16V		16V101M6X7TR2	K46120007		
C 3006	CHIP CAP.	0.01uF	50V	B	GRM40B103M50PT	K22170817		
C 3007	AL. ELECTRO. CAP.	100uF	16V		16V101M6X7TR2	K46120007		
C 3008	FILM CAP.	0.068	50V		50F2U683M	K50177683		
C 3009	AL. ELECTRO. CAP.	10uF	16V		16V100M4X7TR2	K46120004		
C 3010	CHIP CAP.	0.01uF	50V	B	GRM40B103M50PT	K22170817		
C 3011	AL. ELECTRO. CAP.	100uF	50V		50V101M8X11TR5	K46170025		
C 3012	CHIP CAP.	0.001uF	50V	B	GRM40B102M50PT	K22170805		
C 3013	CHIP CAP.	0.001uF	50V	B	GRM40B102M50PT	K22170805		
C 3015	CHIP CAP.	0.01uF	50V	B	GRM40B103M50PT	K22170817		
C 3016	CHIP CAP.	0.001uF	50V	B	GRM40B102M50PT	K22170805		
C 3017	CHIP CAP.	0.001uF	50V	B	GRM40B102M50PT	K22170805		
C 3018	CHIP CAP.	0.001uF	50V	B	GRM40B102M50PT	K22170805		
C 3019	CHIP CAP.	0.001uF	50V	B	GRM40B102M50PT	K22170805		
C 3020	CHIP CAP.	0.001uF	50V	B	GRM40B102M50PT	K22170805		
C 3021	CHIP CAP.	0.001uF	50V	B	GRM40B102M50PT	K22170805		
C 3022	CHIP CAP.	0.001uF	50V	B	GRM40B102M50PT	K22170805		
C 3023	CHIP CAP.	0.001uF	50V	B	GRM40B102M50PT	K22170805		
C 3024	CHIP CAP.	0.001uF	50V	B	GRM40B102M50PT	K22170805		
C 3025	AL. ELECTRO. CAP.	10uF	16V		16V100M4X7TR2	K46120004		
C 3026	CHIP CAP.	0.01uF	50V	B	GRM40B103M50PT	K22170817		
C 3027	AL. ELECTRO. CAP.	100uF	10V		UVR1A101MCA6	K40109028		
C 3028	CHIP CAP.	0.001uF	50V	B	GRM40B102M50PT	K22170805		
C 3029	CHIP CAP.	0.001uF	50V	B	GRM40B102M50PT	K22170805		
C 3030	CHIP CAP.	0.001uF	50V	B	GRM40B102M50PT	K22170805		
C 3031	CHIP CAP.	0.01uF	50V	B	GRM40B103M50PT	K22170817		
C 3032	AL. ELECTRO. CAP.	10uF	16V		16V100M4X7TR2	K46120004		
C 3033	CHIP CAP.	33pF	50V	CH	GRM40CH330J50PT	K22170223		
C 3034	CHIP CAP.	33pF	50V	CH	GRM40CH330J50PT	K22170223		
C 3035	CHIP CAP.	0.001uF	50V	B	GRM40B102M50PT	K22170805		
C 3036	CHIP CAP.	27pF	50V	CH	GRM40CH270J50PT	K22170221		
C 3037	CHIP CAP.	27pF	50V	CH	GRM40CH270J50PT	K22170221		
C 3038	TANTALUM CHIP CAP.	1uF	16V		TESVA1C105M1-8R	K78120009		
C 3039	CHIP CAP.	0.01uF	50V	B	GRM40B103M50PT	K22170817		
C 3040	CHIP CAP.	0.1uF	25V	B	GRM40B104M25PT	K22140811		
C 3041	CHIP CAP.	0.001uF	50V	B	GRM40B102M50PT	K22170805		
C 3042	CHIP CAP.	0.001uF	50V	B	GRM40B102M50PT	K22170805		
C 3043	CHIP CAP.	0.001uF	50V	B	GRM40B102M50PT	K22170805		
C 3044	CHIP CAP.	0.001uF	50V	B	GRM40B102M50PT	K22170805		
C 3045	CHIP CAP.	0.001uF	50V	B	GRM40B102M50PT	K22170805		
C 3046	CHIP CAP.	0.001uF	50V	B	GRM40B102M50PT	K22170805		
C 3047	CHIP CAP.	0.001uF	50V	B	GRM40B102M50PT	K22170805		
C 3048	CHIP CAP.	0.001uF	50V	B	GRM40B102M50PT	K22170805		
C 3049	AL. ELECTRO. CAP.	22uF	16V		16V220M5X7TR2	K46120005		

Display Unit

REF.	DESCRIPTION	VALUE	WV	TOL.	MFGR'S DESIG	YAESU P/N	VERS.	Addr
C 3050	AL. ELECTRO. CAP.	10uF	16V		16V100M4X7TR2	K46120004		
C 3051	CHIP CAP.	0.1uF	25V	B	GRM40B104M25PT	K22140811		
C 3052	CHIP CAP.	0.1uF	25V	B	GRM40B104M25PT	K22140811		
C 3053	CHIP CAP.	0.001uF	50V	B	GRM40B102M50PT	K22170805		
C 3054	CHIP CAP.	0.001uF	50V	B	GRM40B102M50PT	K22170805		
C 3060	CHIP CAP.	0.1uF	25V	B	GRM40B104M25PT	K22140811		
C 3061	CHIP CAP.	0.001uF	50V	B	GRM40B102M50PT	K22170805		
C 3062	AL. ELECTRO. CAP.	10uF	16V		16V100M4X7TR2	K46120004		
C 3063	CHIP CAP.	0.01uF	50V	B	GRM40B103M50PT	K22170817		
C 3064	CHIP CAP.	0.1uF	25V	B	GRM40B104M25PT	K22140811		
C 3065	TANTALUM CHIP CAP.	0.47uF	25V		TESVA1E474M1-8R	K78140009		
C 3066	TANTALUM CHIP CAP.	0.47uF	25V		TESVA1E474M1-8R	K78140009		
C 3067	CHIP CAP.	0.001uF	50V	B	GRM40B102M50PT	K22170805		
C 3068	CHIP CAP.	0.001uF	50V	B	GRM40B102M50PT	K22170805		
C 3069	CHIP CAP.	0.001uF	50V	B	GRM40B102M50PT	K22170805		
C 3070	CHIP CAP.	0.001uF	50V	B	GRM40B102M50PT	K22170805		
C 3071	TANTALUM CHIP CAP.	10uF	6.3V		F950J106MTAAF1Q2	K78080003		
C 3072	CHIP CAP.	0.001uF	50V	B	GRM40B102M50PT	K22170805		
C 3073	CHIP CAP.	0.047uF	50V	F	GRM40F473Z50PT	K22171008		
C03001	CERAMIC OSC				CSA8.00MT	H7900580		
C03002	CERAMIC OSC				CSA4.00MG5	H7900170		
D 3001	DIODE				HZ11B1	G2090143		
D 3002	DIODE				1SS184 TE85R	G2070009		
D 3003	DIODE				1SS181 TE85R	G2070001		
D 3004	DIODE				1SS184 TE85R	G2070009		
D 3005	DIODE				1SS83	G2090340		
D 3006	DIODE				HZ7B1	G2090229		
D 3008	DIODE				1SS83	G2090340		
D 3009	DIODE				1SS83	G2090340		
D 3010	DIODE				1SS83	G2090340		
D 3011	DIODE				1SS97	G2090118		
D 3014	DIODE				IMN10 T108	G2070078		
D 3026	DIODE				IMN10 T108	G2070078		
D 3029	DIODE				IMN10 T108	G2070078		
D 3033	DIODE				IMN10 T108	G2070078		
D 3036	DIODE				1SS184 TE85R	G2070009		
D 3037	DIODE				1SS184 TE85R	G2070009		
D 3039	DIODE				1SS181 TE85R	G2070001		
D 3040	DIODE				1SS184 TE85R	G2070009		
D 3041	DIODE				1SS184 TE85R	G2070009		
D 3042	DIODE				1SS184 TE85R	G2070009		
D 3043	DIODE				1SS184 TE85R	G2070009		
D 3044	DIODE				IMN10 T108	G2070078		
D 3047	DIODE				1SS184 TE85R	G2070009		
D 3048	DIODE				1SS184 TE85R	G2070009		
D 3050	LED				GL-9PG4	G2090374		
D 3051	LED				GL-9PR4	G2090375		
D 3053	DIODE				1SS181 TE85R	G2070001		
D 3054	DIODE				1SS184 TE85R	G2070009		
D 3055	DIODE				1SS184 TE85R	G2070009		
D 3056	DIODE				1SS184 TE85R	G2070009		
DS3001	FCD				FIP9BSM8	G6090084		

Display Unit

REF.	DESCRIPTION	VALUE	WV	TOL.	MFGR'S DESIG	YAESU P/N	VERS.	Addr
J 3001	CONNECTOR				SB20-06WS	P0090613		
J 3002	CONNECTOR				SB20-02WS	P0090609		
J 3003	CONNECTOR				SB20-03WS	P0090610		
J 3004	CONNECTOR				SB20-02WS	P0090609		
J 3005	CONNECTOR				SB20-04WS	P0090611		
J 3006	CONNECTOR				SC25-04WS	P0090623		
J 3007	CONNECTOR				SB20-03WS	P0090610		
J 3008	CONNECTOR				SB20-02WS	P0090609		
J 3009	CONNECTOR				SB20-05WS	P0090612		
J 3010	CONNECTOR				SB20-05WS	P0090612		
J 3011	CONNECTOR				52089-1510	P1090724		
J 3012	CONNECTOR				SB20-03WS	P0090610		
J 3013	CONNECTOR				SB20-02WS	P0090609		
J 3014	CONNECTOR				SB20-02WS	P0090609		
J 3015	CONNECTOR				SB20-05WS	P0090612		
J 3016	CONNECTOR				SB20-05WS	P0090612		
J 3017	CONNECTOR				SB20-05WS	P0090612		
J 3018	CONNECTOR				SB20-06WS	P0090613		
J 3019	CONNECTOR				SB20-04WS	P0090611		
J 3020	CONNECTOR				SB20-02WS	P0090609		
J 3021	CONNECTOR				SB20-02WS	P0090609		
J 3022	CONNECTOR				SB20-02WS	P0090609		
JP3001	WIRE-ASSY					T9206134		
L 3001	M. RFC	330uH			RCR-875D-331K	L1190393		
L 3002	M. RFC	150uH			LALO4NA151K	L1190037		
L 3003	M. RFC	330uH			RCR-875D-331K	L1190393		
L 3004	M. RFC	100uH			LALO3NA101K	L1190218		
L 3005	M. RFC	47uH			LALO3NA470K	L1190214		
L 3006	M. RFC	100uH			LAP02TA101K	L1790070		
Q 3001	TRANSISTOR				FA1A4P-T2B	G3070006		b7
Q 3002	TRANSISTOR				FA1A4P-T2B	G3070006		b6
Q 3003	TRANSISTOR				2SD882	G3408820		C4
Q 3004	TRANSISTOR				2SD667C	G3406670C		C5
Q 3005	TRANSISTOR				2SD667C	G3406670C		C5
Q 3006	TRANSISTOR				2SC2712GR TE85R	G3327127G		b6
Q 3007	TRANSISTOR				FA1A4P-T2B	G3070006		b6
Q 3008	IC				AK93C46F E-2	G1091016		a5
Q 3010	TRANSISTOR				2SC2712GR TE85R	G3327127G		c5
Q 3011	TRANSISTOR				2SC2712GR TE85R	G3327127G		c5
Q 3012	TRANSISTOR				FA1A4P-T2B	G3070006		b6
Q 3013	IC				HD404728A53FS	G1091358		A5
Q 3014	TRANSISTOR				2SA1162GR TE85R	G3111627G		b6
Q 3015	TRANSISTOR				2SC2712GR TE85R	G3327127G		b6
Q 3016	TRANSISTOR				2SC2712GR TE85R	G3327127G		a3
Q 3017	TRANSISTOR				2SC2712GR TE85R	G3327127G		a3
Q 3018	IC				M37700E4FP MY-026	G1091551	DST USA	A3
Q 3018	IC				M37700E4FP MY-026	G1091551	DST EXP	A3
Q 3019	TRANSISTOR				FA1A4P-T2B	G3070006		a4
Q 3020	TRANSISTOR				2SC2712GR TE85R	G3327127G		a4
Q 3021	TRANSISTOR				FA1A4P-T2B	G3070006		a6
Q 3023	IC				M51943BML-301	G1090991		a4
Q 3024	IC				UPC7805H	G1090299		C4
Q 3025	IC				TC74HC75AF TP2	G1091184		b5
Q 3026	IC				FQ7924	G1091080		B4

Display Unit

REF.	DESCRIPTION	VALUE	WV	TOL.	MFR'S DESIG	YAESU P/N	VERS.	Addr
Q 3028	TRANSISTOR				FA1A4P-T2B	G3070006		b4
Q 3030	TRANSISTOR				FA1A4P-T2B	G3070006		b6
Q 3031	TRANSISTOR				FN1A4P-T2B	G3070011		b5
Q 3032	TRANSISTOR				FN1A4P-T2B	G3070011		b4
Q 3033	TRANSISTOR				FN1A4P-T2B	G3070011		b4
Q 3034	TRANSISTOR				FN1A4P-T2B	G3070011		b6
Q 3035	TRANSISTOR				FA1A4P-T2B	G3070006		a7
Q 3036	TRANSISTOR				FA1A4P-T2B	G3070006		a3
Q 3038	IC				TC4S71F TE85R	G1090906		b6
Q 3039	TRANSISTOR				FA1A4P-T2B	G3070006		b6
R 3001	CHIP RES.	3. 3K	1/10W		RMC1/10T 332J	J24205332		
R 3002	CHIP RES.	10K	1/10W		RMC1/10T 103J	J24205103		
R 3003	CHIP RES.	470	1/10W		RMC1/10T 471J	J24205471		
R 3004	CHIP RES.	330	1/10W		RMC1/10T 331J	J24205331		
R 3005	CHIP RES.	10K	1/10W		RMC1/10T 103J	J24205103		
R 3006	CHIP RES.	390	1/10W		RMC1/10T 391J	J24205391		
R 3007	CHIP RES.	470	1/10W		RMC1/10T 471J	J24205471		
R 3008	CHIP RES.	330	1/10W		RMC1/10T 331J	J24205331		
R 3009	CHIP RES.	10K	1/10W		RMC1/10T 103J	J24205103		
R 3010	CHIP RES.	10K	1/10W		RMC1/10T 103J	J24205103		
R 3011	CHIP RES.	100K	1/10W		RMC1/10T 104J	J24205104		
R 3012	CHIP RES.	47K	1/10W		RMC1/10T 473J	J24205473		
R 3013	CHIP RES.	10K	1/10W		RMC1/10T 103J	J24205103		
R 3014	CHIP RES.	100K	1/10W		RMC1/10T 104J	J24205104		
R 3015	CHIP RES.	470	1/10W		RMC1/10T 471J	J24205471		
R 3016	CHIP RES.	100K	1/10W		RMC1/10T 104J	J24205104		
R 3018	CHIP RES.	100K	1/10W		RMC1/10T 104J	J24205104		
R 3019	CHIP RES.	100K	1/10W		RMC1/10T 104J	J24205104		
R 3020	CHIP RES.	100K	1/10W		RMC1/10T 104J	J24205104		
R 3021	CHIP RES.	100K	1/10W		RMC1/10T 104J	J24205104		
R 3022	CHIP RES.	100K	1/10W		RMC1/10T 104J	J24205104		
R 3023	CHIP RES.	100K	1/10W		RMC1/10T 104J	J24205104		
R 3024	CHIP RES.	100K	1/10W		RMC1/10T 104J	J24205104		
R 3025	CHIP RES.	100K	1/10W		RMC1/10T 104J	J24205104		
R 3026	CHIP RES.	100K	1/10W		RMC1/10T 104J	J24205104		
R 3027	CHIP RES.	10K	1/10W		RMC1/10T 103J	J24205103		
R 3028	CHIP RES.	100K	1/10W		RMC1/10T 104J	J24205104		
R 3029	CHIP RES.	470	1/10W		RMC1/10T 471J	J24205471		
R 3030	CHIP RES.	100K	1/10W		RMC1/10T 104J	J24205104		
R 3031	CHIP RES.	100K	1/10W		RMC1/10T 104J	J24205104		
R 3032	CHIP RES.	150	1/10W		RMC1/10T 151J	J24205151		
R 3041	CHIP RES.	100K	1/10W		RMC1/10T 104J	J24205104		
R 3042	CHIP RES.	150	1/10W		RMC1/10T 151J	J24205151		
R 3043	CHIP RES.	3. 3K	1/10W		RMC1/10T 332J	J24205332		
R 3044	CHIP RES.	100K	1/10W		RMC1/10T 104J	J24205104		
R 3045	CHIP RES.	470	1/10W		RMC1/10T 471J	J24205471		
R 3046	CHIP RES.	100K	1/10W		RMC1/10T 104J	J24205104		
R 3047	CHIP RES.	10K	1/10W		RMC1/10T 103J	J24205103		
R 3048	CHIP RES.	100K	1/10W		RMC1/10T 104J	J24205104		
R 3049	CHIP RES.	10K	1/10W		RMC1/10T 103J	J24205103		
R 3050	CHIP RES.	470	1/10W		RMC1/10T 471J	J24205471		
R 3051	CHIP RES.	100K	1/10W		RMC1/10T 104J	J24205104		
R 3052	CHIP RES.	470	1/10W		RMC1/10T 471J	J24205471		
R 3053	CHIP RES.	470	1/10W		RMC1/10T 471J	J24205471		
R 3054	CHIP RES.	10K	1/10W		RMC1/10T 103J	J24205103		

Display Unit

REF.	DESCRIPTION	VALUE	WV	TOL.	MFR'S DESIG	YAESU P/N	VERS.	Addr
R 3055	CHIP RES.	470	1/10W		RMC1/10T 471J	J24205471		
R 3056	CHIP RES.	470	1/10W		RMC1/10T 471J	J24205471		
R 3057	CHIP RES.	470	1/10W		RMC1/10T 471J	J24205471		
R 3058	CHIP RES.	470	1/10W		RMC1/10T 471J	J24205471		
R 3059	CHIP RES.	47	1/10W		RMC1/10T 470J	J24205470		
R 3060	CHIP RES.	100K	1/10W		RMC1/10T 104J	J24205104		
R 3061	CHIP RES.	1K	1/10W		RMC1/10T 102J	J24205102		
R 3062	CHIP RES.	470	1/10W		RMC1/10T 471J	J24205471		
R 3063	CHIP RES.	470	1/10W		RMC1/10T 471J	J24205471		
R 3064	CHIP RES.	22K	1/10W		RMC1/10T 223J	J24205223		
R 3065	CHIP RES.	470	1/10W		RMC1/10T 471J	J24205471		
R 3066	CHIP RES.	1M	1/10W		RMC1/10T 105J	J24205105		
R 3067	CHIP RES.	10K	1/10W		RMC1/10T 103J	J24205103		
R 3068	CHIP RES.	4.7K	1/10W		RMC1/10T 472J	J24205472		
R 3069	CHIP RES.	470	1/10W		RMC1/10T 471J	J24205471		
R 3070	CHIP RES.	10K	1/10W		RMC1/10T 103J	J24205103		
R 3071	CHIP RES.	10K	1/10W		RMC1/10T 103J	J24205103		
R 3072	CHIP RES.	47K	1/10W		RMC1/10T 473J	J24205473		
R 3073	CHIP RES.	1M	1/10W		RMC1/10T 105J	J24205105		
R 3074	CHIP RES.	10K	1/10W		RMC1/10T 103J	J24205103		
R 3075	CHIP RES.	10K	1/10W		RMC1/10T 103J	J24205103		
R 3076	CHIP RES.	10K	1/10W		RMC1/10T 103J	J24205103		
R 3077	CHIP RES.	10K	1/10W		RMC1/10T 103J	J24205103		
R 3078	CHIP RES.	1.5K	1/10W		RMC1/10T 152J	J24205152		
R 3079	CHIP RES.	10K	1/10W		RMC1/10T 103J	J24205103		
R 3080	CHIP RES.	150	1/10W		RMC1/10T 151J	J24205151		
R 3081	CHIP RES.	150	1/10W		RMC1/10T 151J	J24205151		
R 3082	CHIP RES.	150	1/10W		RMC1/10T 151J	J24205151		
R 3083	CHIP RES.	150	1/10W		RMC1/10T 151J	J24205151		
R 3084	CHIP RES.	150	1/10W		RMC1/10T 151J	J24205151		
R 3085	CHIP RES.	150	1/10W		RMC1/10T 151J	J24205151		
R 3086	CHIP RES.	150	1/10W		RMC1/10T 151J	J24205151		
R 3087	CHIP RES.	150	1/10W		RMC1/10T 151J	J24205151		
R 3088	CHIP RES.	150	1/10W		RMC1/10T 151J	J24205151		
R 3089	CHIP RES.	150	1/10W		RMC1/10T 151J	J24205151		
R 3090	CHIP RES.	150	1/10W		RMC1/10T 151J	J24205151		
R 3091	CHIP RES.	330	1/10W		RMC1/10T 331J	J24205331		
R 3092	CHIP RES.	100K	1/10W		RMC1/10T 104J	J24205104		
R 3093	CHIP RES.	1K	1/10W		RMC1/10T 102J	J24205102		
R 3095	CHIP RES.	10K	1/10W		RMC1/10T 103J	J24205103		
R 3096	CHIP RES.	1K	1/10W		RMC1/10T 102J	J24205102		
R 3097	CHIP RES.	4.7K	1/10W		RMC1/10T 472J	J24205472		
R 3098	CHIP RES.	1K	1/10W		RMC1/10T 102J	J24205102		
R 3099	CHIP RES.	10K	1/10W		RMC1/10T 103J	J24205103		
R 3100	CHIP RES.	10K	1/10W		RMC1/10T 103J	J24205103		
R 3101	CHIP RES.	1K	1/10W		RMC1/10T 102J	J24205102		
R 3102	CHIP RES.	47K	1/10W		RMC1/10T 473J	J24205473		
R 3103	CHIP RES.	150	1/10W		RMC1/10T 151J	J24205151		
R 3104	CHIP RES.	1K	1/10W		RMC1/10T 102J	J24205102		
R 3105	CHIP RES.	470	1/10W		RMC1/10T 471J	J24205471		
R 3107	CHIP RES.	1K	1/10W		RMC1/10T 102J	J24205102		
R 3108	CHIP RES.	470	1/10W		RMC1/10T 471J	J24205471		
R 3109	CHIP RES.	1K	1/10W		RMC1/10T 102J	J24205102		
R 3110	CHIP RES.	3.3K	1/10W		RMC1/10T 332J	J24205332		
R 3111	CHIP RES.	1K	1/10W		RMC1/10T 102J	J24205102		
R 3112	CHIP RES.	470	1/10W		RMC1/10T 471J	J24205471		

Display Unit

REF.	DESCRIPTION	VALUE	WV	TOL.	MFGR'S DESIG	YAESU P/N	VERS.	Addr
R 3113	CHIP RES.	33K	1/10W		RMC1/10T 333J	J24205333		
R 3114	CHIP RES.	33K	1/10W		RMC1/10T 333J	J24205333		
R 3115	CHIP RES.	470	1/10W		RMC1/10T 471J	J24205471		
R 3116	CHIP RES.	470	1/10W		RMC1/10T 471J	J24205471		
R 3117	CHIP RES.	470	1/10W		RMC1/10T 471J	J24205471		
R 3118	CHIP RES.	470	1/10W		RMC1/10T 471J	J24205471		
R 3119	CHIP RES.	10	1/10W		RMC1/10T 100J	J24205100		
R 3121	CHIP RES.	470	1/10W		RMC1/10T 471J	J24205471		
R 3122	CHIP RES.	3. 3K	1/10W		RMC1/10T 332J	J24205332		
R 3123	CHIP RES.	4. 7K	1/10W		RMC1/10T 472J	J24205472		
R 3128	CHIP RES.	470	1/10W		RMC1/10T 471J	J24205471		
R 3129	CHIP RES.	1K	1/10W		RMC1/10T 102J	J24205102		
R 3131	CHIP RES.	150	1/10W		RMC1/10T 151J	J24205151		
R 3132	CHIP RES.	150	1/10W		RMC1/10T 151J	J24205151		
R 3133	CHIP RES.	10K	1/10W		RMC1/10T 103J	J24205103		
R 3134	CHIP RES.	10K	1/10W		RMC1/10T 103J	J24205103		
R 3136	CHIP RES.	10K	1/10W		RMC1/10T 103J	J24205103		
R 3137	CHIP RES.	10K	1/10W		RMC1/10T 103J	J24205103		
R 3139	CHIP RES.	330	1/10W		RMC1/10T 331J	J24205331		
R 3140	CHIP RES.	10K	1/10W		RMC1/10T 103J	J24205103		
R 3141	CHIP RES.	10K	1/10W		RMC1/10T 103J	J24205103		
R 3142	CHIP RES.	10K	1/10W		RMC1/10T 103J	J24205103		
R 3143	CHIP RES.	0	1/10W		RMC1/10T 000J	J24205000		
R 3144	CHIP RES.	10K	1/10W		RMC1/10T 103J	J24205103		
R 3146	CHIP RES.	1K	1/10W		RMC1/10T 102J	J24205102		
R 3147	CHIP RES.	1K	1/10W		RMC1/10T 102J	J24205102		
R 3148	CHIP RES.	1K	1/10W		RMC1/10T 102J	J24205102		
R 3149	CHIP RES.	1K	1/10W		RMC1/10T 102J	J24205102		
R 3150	CHIP RES.	1K	1/10W		RMC1/10T 102J	J24205102		
R 3151	CHIP RES.	47	1/10W		RMC1/10T 470J	J24205470		
R 3152	CHIP RES.	47	1/10W		RMC1/10T 470J	J24205470		
R 3153	CHIP RES.	47K	1/10W		RMC1/10T 473J	J24205473		
RB3001	BLOCK RES.				EXB-LE4104S	J40900176		
RB3003	BLOCK RES.				EXB-F5E104J	J40900177		
RB3004	BLOCK RES.				EXB-F5E104J	J40900177		
S 3001	SLIDE SWITCH				SSS212299	N6090051		
S 3002	TACT SWITCH				SKHQFE	N5090057		
S 3003	TACT SWITCH				SKHQFE	N5090057		
S 3004	TACT SWITCH				SKHQFE	N5090057		
S 3005	TACT SWITCH				SKHQFE	N5090057		
S 3006	TACT SWITCH				SKHQFE	N5090057		
S 3007	TACT SWITCH				SKHQFE	N5090057		
S 3008	TACT SWITCH				SKHQFE	N5090057		
S 3009	TACT SWITCH				SKHQFE	N5090057		
S 3010	TACT SWITCH				SKHQFE	N5090057		
S 3011	TACT SWITCH				SKHQFE	N5090057		
S 3012	TACT SWITCH				SKHQFC	N5090055		
S 3013	TACT SWITCH				SKHQFC	N5090055		
S 3014	TACT SWITCH				SKHQFC	N5090055		
T 3001	TRANS.				EER-137	L3030138		
VR3001	POT.	10KB			H0651A013-10KB	J51745103		
VR3002	POT.	10KB			H0651A013-10KB	J51745103		

Display Unit

REF.	DESCRIPTION	VALUE	WV	TOL.	MFGR'S DESIG	YAESU P/N	VERS.	Addr
VR3003	POT.	10KB			H0651A013-10KB	J51745103		
VR3004	POT.	10KB			H0651A013-10KB	J51745103		

Notes

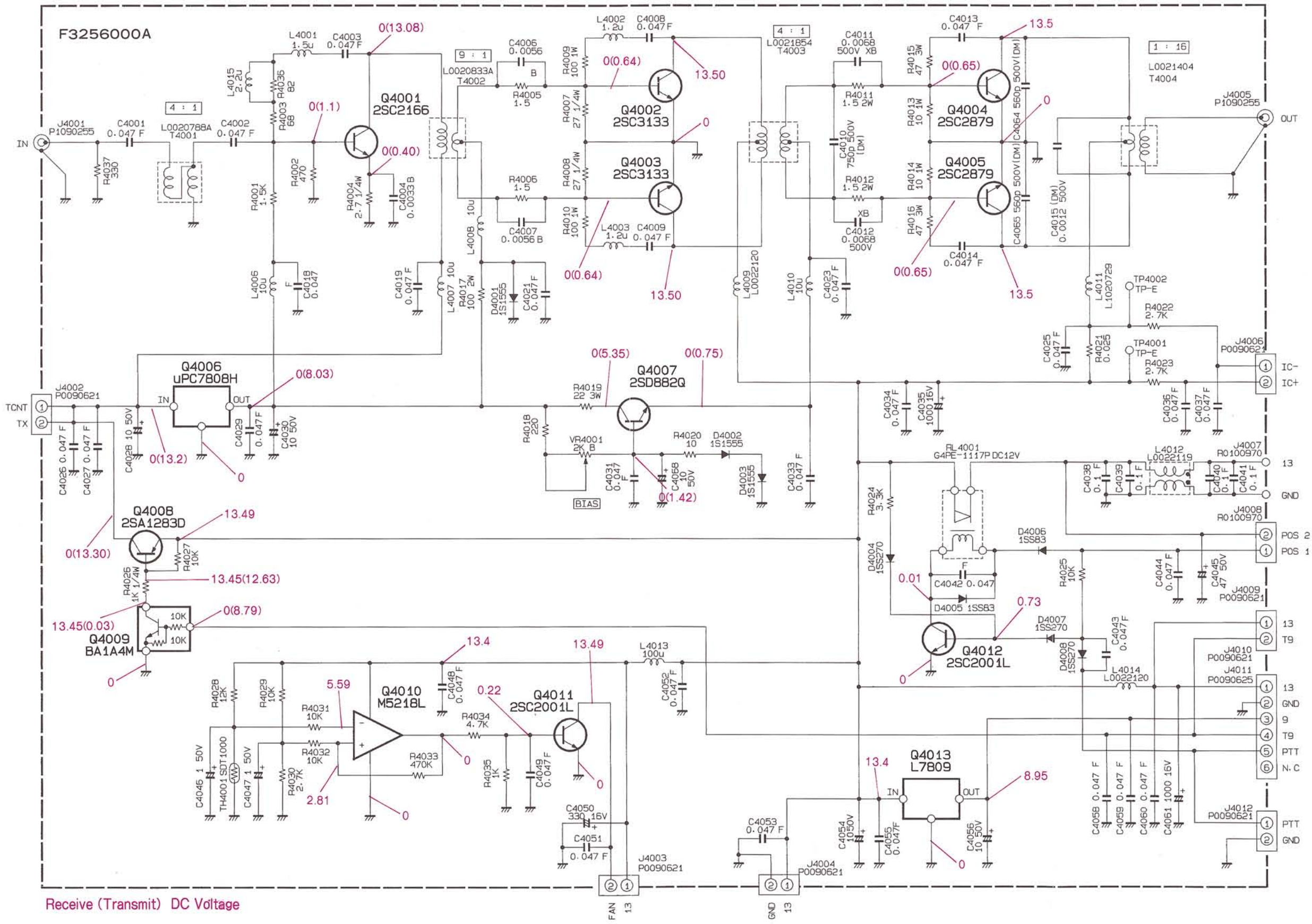

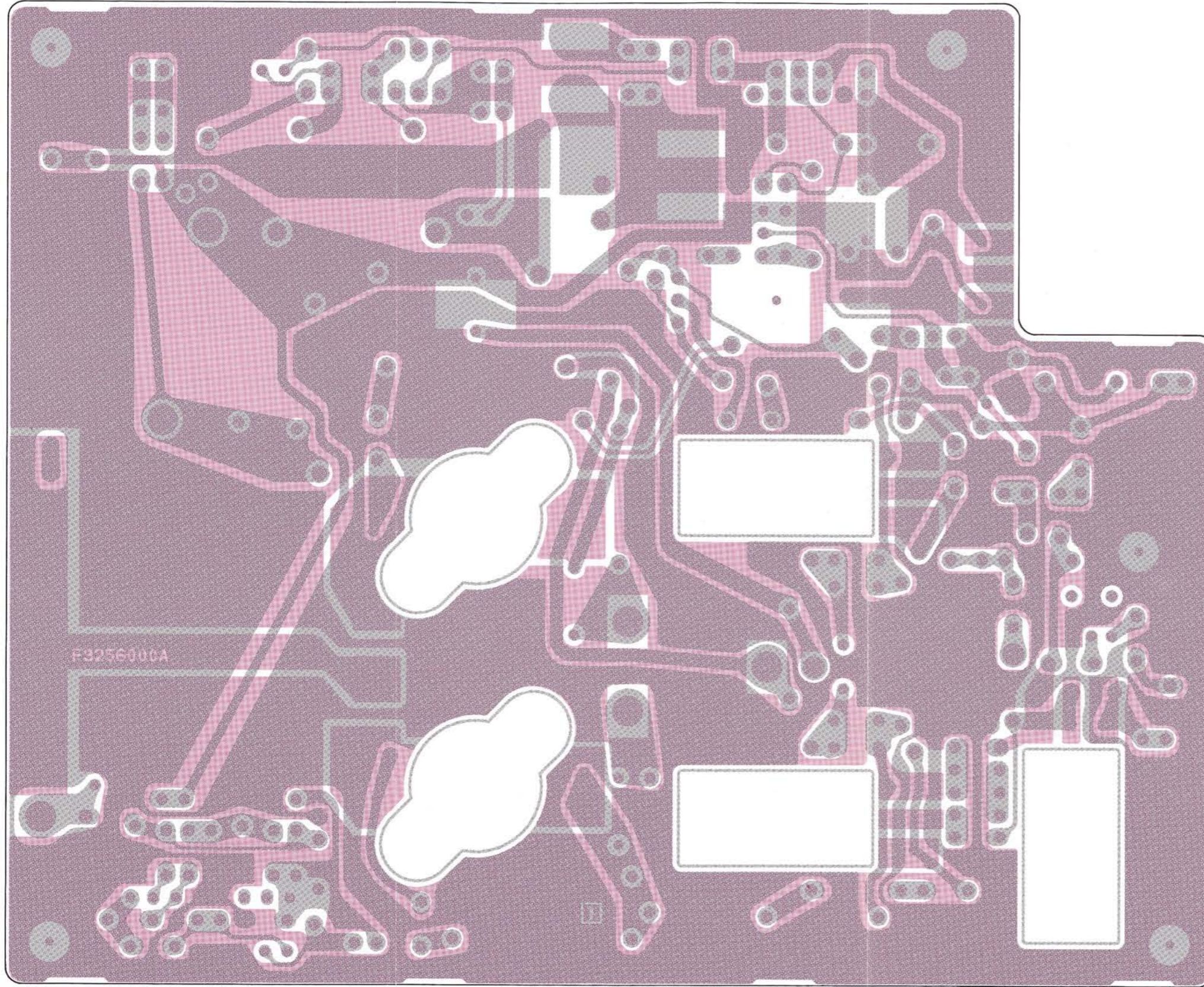

"solder" side

100W PA Unit

REF.	DESCRIPTION	VALUE	WV	TOL.	MFGR'S DESIG	YAESU P/N	VERS.	Addr
*** 100W-PA UNIT ***								
	PCB W COMP.					CS1093001		
	PCB W/O COMP.					F3256000A		
C 4001	CERAMIC CAP.	0.047uF	50V	F	UP050F473Z-A-B	K28179002		
C 4002	CERAMIC CAP.	0.047uF	50V	F	UP050F473Z-A-B	K28179002		
C 4003	CERAMIC CAP.	0.047uF	50V	F	UP050F473Z-A-B	K28179002		
C 4004	CERAMIC CAP.	0.0033uF	50V	B	DD107-979B332K50	K26171620		
C 4006	CERAMIC CAP.	0.0056uF	50V	B	DD109-979B562K50	K26171623		
C 4007	CERAMIC CAP.	0.0056uF	50V	B	DD109-979B562K50	K26171623		
C 4008	CERAMIC CAP.	0.047uF	50V	F	UP050F473Z-A-B	K28179002		
C 4009	CERAMIC CAP.	0.047uF	50V	F	UP050F473Z-A-B	K28179002		
C 4010	MICA CAP.	750p	500V		DM19D751J5	K30279092		
C 4011	CERAMIC CAP.	0.0068uF	500V	XB	CD130XB682K500	K10276682		
C 4012	CERAMIC CAP.	0.0068uF	500V	XB	CD130XB682K500	K10276682		
C 4013	CERAMIC CAP.	0.047uF	50V	F	UP050F473Z-A-B	K28179002		
C 4014	CERAMIC CAP.	0.047uF	50V	F	UP050F473Z-A-B	K28179002		
C 4015	MICA CAP.	1200p	500V		DM19D122J5	K30279095		
C 4018	CERAMIC CAP.	0.047uF	50V	F	UP050F473Z-A-B	K28179002		
C 4019	CERAMIC CAP.	0.047uF	50V	F	UP050F473Z-A-B	K28179002		
C 4021	CERAMIC CAP.	0.047uF	50V	F	UP050F473Z-A-B	K28179002		
C 4023	CERAMIC CAP.	0.047uF	50V	F	UP050F473Z-A-B	K28179002		
C 4025	CERAMIC CAP.	0.047uF	50V	F	UP050F473Z-A-B	K28179002		
C 4026	CERAMIC CAP.	0.047uF	50V	F	UP050F473Z-A-B	K28179002		
C 4027	CERAMIC CAP.	0.047uF	50V	F	UP050F473Z-A-B	K28179002		
C 4028	AL. ELECTRO. CAP.	10uF	50V		50V100M5X11TR5	K46170021		
C 4029	CERAMIC CAP.	0.047uF	50V	F	UP050F473Z-A-B	K28179002		
C 4030	AL. ELECTRO. CAP.	10uF	50V		50V100M5X11TR5	K46170021		
C 4031	CERAMIC CAP.	0.047uF	50V	F	UP050F473Z-A-B	K28179002		
C 4033	CERAMIC CAP.	0.047uF	50V	F	UP050F473Z-A-B	K28179002		
C 4034	CERAMIC CAP.	0.047uF	50V	F	UP050F473Z-A-B	K28179002		
C 4035	AL. ELECTRO. CAP.	1000uF	16V		16R102S 13X16	K40129021		
C 4036	CERAMIC CAP.	0.047uF	50V	F	UP050F473Z-A-B	K28179002		
C 4037	CERAMIC CAP.	0.047uF	50V	F	UP050F473Z-A-B	K28179002		
C 4038	CERAMIC CAP.	0.1uF	50V	F	UP050F104Z-A-B	K28179003		
C 4039	CERAMIC CAP.	0.1uF	50V	F	UP050F104Z-A-B	K28179003		
C 4040	CERAMIC CAP.	0.1uF	50V	F	UP050F104Z-A-B	K28179003		
C 4041	CERAMIC CAP.	0.1uF	50V	F	UP050F104Z-A-B	K28179003		
C 4042	CERAMIC CAP.	0.047uF	50V	F	UP050F473Z-A-B	K28179002		
C 4043	CERAMIC CAP.	0.047uF	50V	F	UP050F473Z-A-B	K28179002		
C 4044	CERAMIC CAP.	0.047uF	50V	F	UP050F473Z-A-B	K28179002		
C 4045	AL. ELECTRO. CAP.	47uF	50V		RE2-50V470M	K40179028		
C 4046	AL. ELECTRO. CAP.	1uF	50V		50V010M5X11TR5	K46170017		
C 4047	AL. ELECTRO. CAP.	1uF	50V		50V010M5X11TR5	K46170017		
C 4048	CERAMIC CAP.	0.047uF	50V	F	UP050F473Z-A-B	K28179002		
C 4049	CERAMIC CAP.	0.047uF	50V	F	UP050F473Z-A-B	K28179002		
C 4050	AL. ELECTRO. CAP.	330uF	16V		16V331M8X11TR5	K46120002		
C 4051	CERAMIC CAP.	0.047uF	50V	F	UP050F473Z-A-B	K28179002		
C 4052	CERAMIC CAP.	0.047uF	50V	F	UP050F473Z-A-B	K28179002		
C 4053	CERAMIC CAP.	0.047uF	50V	F	UP050F473Z-A-B	K28179002		
C 4054	AL. ELECTRO. CAP.	10uF	50V		50V100M5X11TR5	K46170021		
C 4055	CERAMIC CAP.	0.047uF	50V	F	UP050F473Z-A-B	K28179002		
C 4056	AL. ELECTRO. CAP.	10uF	50V		50V100M5X11TR5	K46170021		
C 4058	CERAMIC CAP.	0.047uF	50V	F	UP050F473Z-A-B	K28179002		

100W PA Unit

REF.	DESCRIPTION	VALUE	WV	TOL.	MFGR'S DESIG	YAESU P/N	VERS.	Addr
C 4059	CERAMIC CAP.	0.047uF	50V	F	UP050F473Z-A-B	K28179002		
C 4060	CERAMIC CAP.	0.047uF	50V	F	UP050F473Z-A-B	K28179002		
C 4061	AL. ELECTRO. CAP.	1000uF	16V		16R102S 13X16	K40129021		
C 4064	MICA CAP.	560p	500V		LCQ18561J5	K30275561		
C 4065	MICA CAP.	560p	500V		LCQ18561J5	K30275561		
C 4068	AL. ELECTRO. CAP.	10uF	50V		50V100MSX11TR5	K46170021		
D 4001	DIODE				1S1555	G2015550		
D 4002	DIODE				1S1555	G2015550		
D 4003	DIODE				1S1555	G2015550		
D 4004	DIODE				1SS270TJ	G2060004		
D 4005	DIODE				1SS83RE	G2050007		
D 4006	DIODE				1SS83RE	G2050007		
D 4007	DIODE				1SS270TJ	G2060004		
D 4008	DIODE				1SS270TJ	G2060004		
J 4001	CONNECTOR				TMP-J01X-A2	P1090255		
J 4002	CONNECTOR				SC25-02WS	P0090621		
J 4003	CONNECTOR				SC25-02WS	P0090621		
J 4004	CONNECTOR				SC25-02WS	P0090621		
J 4005	CONNECTOR				TMP-J01X-A2	P1090255		
J 4006	CONNECTOR				SC25-02WS	P0090621		
J 4007	TERMINAL					R0100970		
J 4008	TERMINAL					R0100970		
J 4009	CONNECTOR				SC25-02WS	P0090621		
J 4010	CONNECTOR				SC25-02WS	P0090621		
J 4011	CONNECTOR				SC25-06WS	P0090625		
J 4012	CONNECTOR				SC25-02WS	P0090621		
L 4001	M. RFC	1.5u			LAP02TA1R5K	L1790048		
L 4002	M. RFC	1.2u			LAL03TA1R2M	L1790084		
L 4003	M. RFC	1.2u			LAL03TA1R2M	L1790084		
L 4006	M. RFC	10uH			LAP02TA100K	L1790058		
L 4007	M. RFC	10uH			LAP02TA100K	L1790058		
L 4008	M. RFC	10uH			LAP02TA100K	L1790058		
L 4009	COIL				10U 3A EI9.3	L0022120		
L 4010	M. RFC	10uH			LAL04NA100K	L1190138		
L 4011	RFC				3A RI5.8X6.4-2	L1020729		
L 4012	COIL				D12A RI16X8X8	L0022119		
L 4013	M. RFC	100uH			LAL04NA101K	L1190133		
L 4014	COIL				10U 3A EI9.3	L0022120		
L 4015	M. RFC	2.2uH			LAP02TA2R2K	L1790050		
Q 4001	TRANSISTOR				2SC2166	G3321660		D3
Q 4002	TRANSISTOR				2SC3133-21	G3090086		D4
Q 4003	TRANSISTOR				2SC3133-21	G3090086		C4
Q 4004	TRANSISTOR				2SC2879	G3328790		D5
Q 4005	TRANSISTOR				2SC2879	G3328790		C5
Q 4006	IC				UPC7808H	G1090294		C3
Q 4007	TRANSISTOR				2SD882Q	G3408820Q		B4
Q 4008	TRANSISTOR				2SA1283D	G3112830D		B4
Q 4009	TRANSISTOR				BA1A4M-T	G3050001		A4
Q 4010	IC				M5218L	G1090649		D7
Q 4011	TRANSISTOR				2SC2001-L	G3320010L		E6
Q 4012	TRANSISTOR				2SC2001-L	G3320010L		A6
Q 4013	IC				L7809	G1090778		B3

100W PA Unit

REF.	DESCRIPTION	VALUE	WV	TOL.	MFGR'S DESIG	YAESU P/N	VERS.	Addr
R 4001	CARBON FILM RES.	1.5K	1/6W		RD16TPJ152	J07225152		
R 4002	CARBON FILM RES.	470	1/6W		RD16TPJ471	J07225471		
R 4003	CARBON FILM RES.	68	1/6W		RD16TPJ680	J07225680		
R 4004	CARBON FILM RES.	2.7	1/4W		RD14TJ2R7	J01245279		
R 4005	CARBON FILM RES.	1.5	1/6W		RD16TPJ1R5	J07225159		
R 4006	CARBON FILM RES.	1.5	1/6W		RD16TPJ1R5	J07225159		
R 4007	CARBON FILM RES.	27	1/4W		RD14TJ270	J01245270		
R 4008	CARBON FILM RES.	27	1/4W		RD14TJ270	J01245270		
R 4009	METAL FILM RES.	100	1W		ERG-1SJ101P	J22309010		
R 4010	METAL FILM RES.	100	1W		ERG-1SJ101P	J22309010		
R 4011	METAL FILM RES.	1.5	2W		ERX-2SJ1R5P	J22339002		
R 4012	METAL FILM RES.	1.5	2W		ERX-2SJ1R5P	J22339002		
R 4013	METAL FILM RES.	10	1W		ERG-1SJ100P	J22309024		
R 4014	METAL FILM RES.	10	1W		ERG-1SJ100P	J22309024		
R 4015	METAL FILM RES.	47	3W		ERG-3SJ470P	J22359024		
R 4016	METAL FILM RES.	47	3W		ERG-3SJ470P	J22359024		
R 4017	METAL FILM RES.	100	2W		ERG-2SJ101P	J22339006		
R 4018	CARBON FILM RES.	220	1/6W		RD16TPJ221	J07225221		
R 4019	METAL FILM RES.	22	3W		ERG-3SJ220P	J22359025		
R 4020	CARBON FILM RES.	10	1/6W		RD16TPJ100	J07225100		
R 4021	SHUNT RES.	0.025			R025J	J32009016		
R 4022	CARBON FILM RES.	2.7K	1/6W		RD16TPJ272	J07225272		
R 4023	CARBON FILM RES.	2.7K	1/6W		RD16TPJ272	J07225272		
R 4024	CARBON FILM RES.	3.3K	1/6W		RD16TPJ332	J07225332		
R 4025	CARBON FILM RES.	10K	1/6W		RD16TPJ103	J07225103		
R 4026	CARBON FILM RES.	1K	1/4W		RD14TJ102	J01245102		
R 4027	CARBON FILM RES.	10K	1/6W		RD16TPJ103	J07225103		
R 4028	CARBON FILM RES.	12K	1/6W		RD16TPJ123	J07225123		
R 4029	CARBON FILM RES.	10K	1/6W		RD16TPJ103	J07225103		
R 4030	CARBON FILM RES.	2.7K	1/6W		RD16TPJ272	J07225272		
R 4031	CARBON FILM RES.	10K	1/6W		RD16TPJ103	J07225103		
R 4032	CARBON FILM RES.	10K	1/6W		RD16TPJ103	J07225103		
R 4033	CARBON FILM RES.	470K	1/6W		RD16TPJ474	J07225474		
R 4034	CARBON FILM RES.	4.7K	1/6W		RD16TPJ472	J07225472		
R 4035	CARBON FILM RES.	1K	1/6W		RD16TPJ102	J07225102		
R 4036	CARBON FILM RES.	82	1/6W		RD16TPJ820	J07225820		
R 4037	CARBON FILM RES.	330	1/6W		RD16TPJ331	J07225331		
RL4001	RELAY		DC12V		G4PE-1117P	M1190095		
T 4001	COIL				4-1 2D3 TR6X3	L0020788A		
T 4002	COIL				3A RIB8X14	L0020833A		
T 4003	COIL				D12A RIB10	L0021854		
T 4004	COIL				D12A RIB16	L0021404		
TH4001	THERMISTOR				SDT1000	G9090011		
TP4001	TP-E/				TP-E/MS-60124	Q5000016		
TP4002	TP-E/				TP-E/MS-60124	Q5000016		
VR4001	POT.	2K			EVN-DXAA03B23	J51783202		

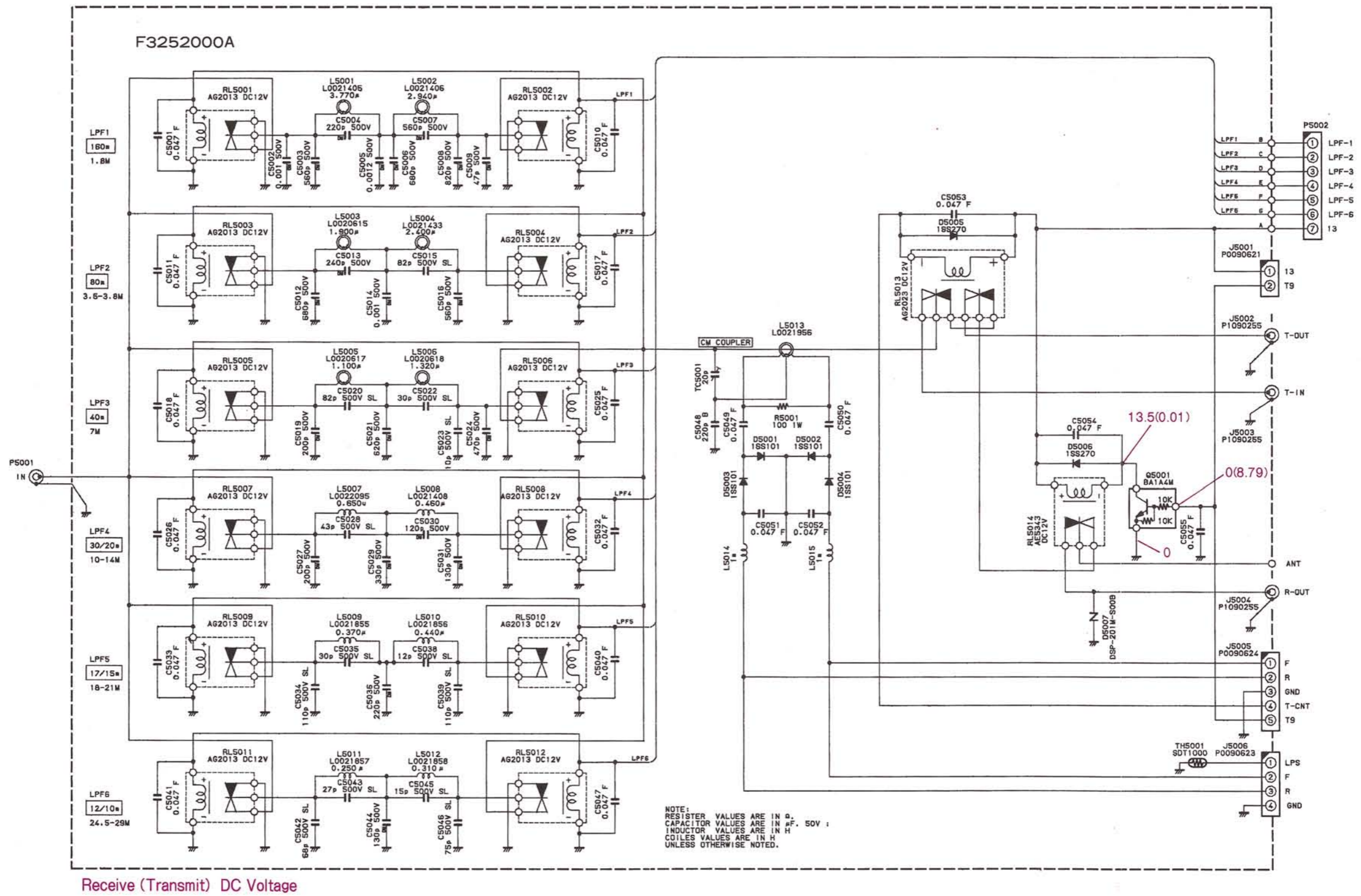

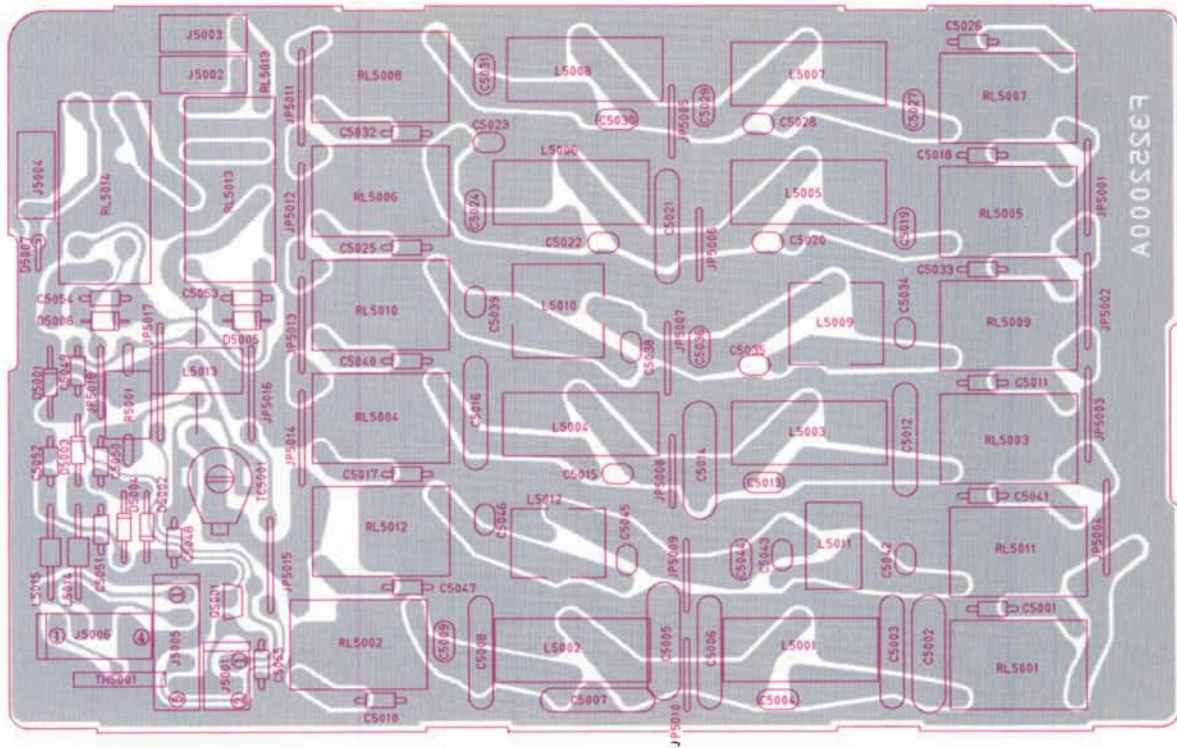

“component” side

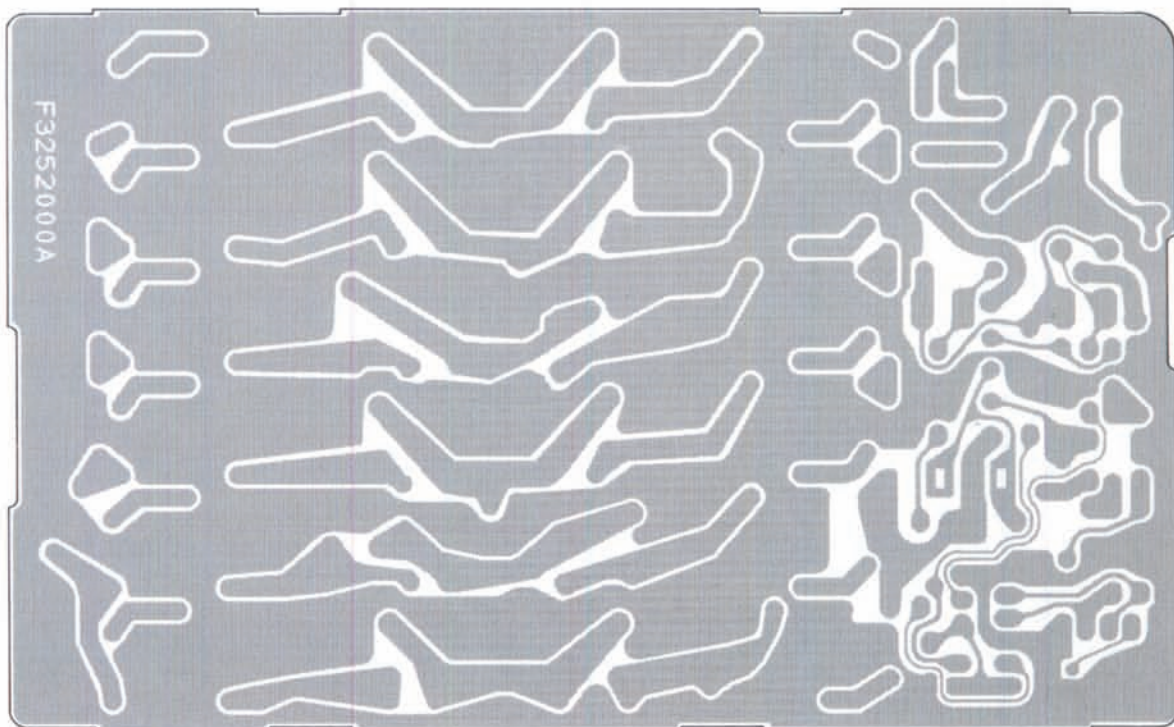

“solder” side

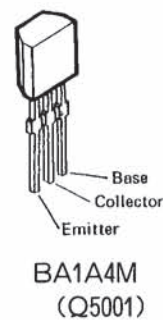
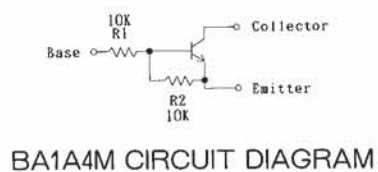

REF.	DESCRIPTION	VALUE	WV	TOL.	MFGR'S DESIG	YAESU P/N	VERS.	Addr
*** LPF UNIT ***								
	PCB W COMP.					CA0495001		
	PCB W/O COMP.					F3252000A		
C 5001	CERAMIC CAP.	0.047uF	50V	F	UP050F473Z-A-B	K28179002		
C 5002	MICA CAP.	0.001	500V		LCQ21102J5	K30275102		
C 5003	MICA CAP.	560pF	500V		LCQ18561J5	K30275561		
C 5004	MICA CAP.	220pF	500V		LCQ17221J5	K30275221		
C 5005	MICA CAP.	0.0012	500V		LCQ21122J5	K30275122		
C 5006	MICA CAP.	680pF	500V		LCQ18681J5	K30275681		
C 5007	MICA CAP.	560pF	500V		LCQ18561J5	K30275561		
C 5008	MICA CAP.	820pF	500V		LCQ18821J5	K30275821		
C 5009	MICA CAP.	47pF	500V		LCQ12470J5	K30275470		
C 5010	CERAMIC CAP.	0.047uF	50V	F	UP050F473Z-A-B	K28179002		
C 5011	CERAMIC CAP.	0.047uF	50V	F	UP050F473Z-A-B	K28179002		
C 5012	MICA CAP.	680pF	500V		LCQ18681J5	K30275681		
C 5013	MICA CAP.	240p	500V		LCQ17241J5	K30275241		
C 5014	MICA CAP.	0.001	500V		LCQ21102J5	K30275102		
C 5015	CERAMIC CAP.	82pF	500V	SL	DD06-979SL820K500	K26270035		
C 5016	MICA CAP.	560pF	500V		LCQ18561J5	K30275561		
C 5017	CERAMIC CAP.	0.047uF	50V	F	UP050F473Z-A-B	K28179002		
C 5018	CERAMIC CAP.	0.047uF	50V	F	UP050F473Z-A-B	K28179002		
C 5019	MICA CAP.	200p	500V		LCQ17201J5	K30275201		
C 5020	CERAMIC CAP.	82pF	500V	SL	DD06-979SL820K500	K26270035		
C 5021	MICA CAP.	620p	500V		LCQ18621J5	K30275621		
C 5022	CERAMIC CAP.	30p	500V	SL	DD05-979SL300K500	K26270024		
C 5023	CERAMIC CAP.	10pF	500V	SL	DD05-979SL100D500	K26270013		
C 5024	MICA CAP.	470pF	500V		LCQ17471J5	K30275471		
C 5025	CERAMIC CAP.	0.047uF	50V	F	UP050F473Z-A-B	K28179002		
C 5026	CERAMIC CAP.	0.047uF	50V	F	UP050F473Z-A-B	K28179002		
C 5027	MICA CAP.	200p	500V		LCQ17201J5	K30275201		
C 5028	CERAMIC CAP.	43p	500V	SL	DD05-979SL430K500	K26270028		
C 5029	MICA CAP.	330pF	500V		LCQ17331J5	K30275331		
C 5030	MICA CAP.	120pF	500V		LCQ17121J5	K30275121		
C 5031	MICA CAP.	130p	500V		LCQ17131J5	K30275131		
C 5032	CERAMIC CAP.	0.047uF	50V	F	UP050F473Z-A-B	K28179002		
C 5033	CERAMIC CAP.	0.047uF	50V	F	UP050F473Z-A-B	K28179002		
C 5034	CERAMIC CAP.	110p	500V	SL	DD07-979SL111K500	K26270038		
C 5035	CERAMIC CAP.	30p	500V	SL	DD05-979SL300K500	K26270024		
C 5036	MICA CAP.	220pF	500V		LCQ17221J5	K30275221		
C 5038	CERAMIC CAP.	12pF	500V	SL	DD05-979SL120K500	K26270015		
C 5039	CERAMIC CAP.	110p	500V	SL	DD07-979SL111K500	K26270038		
C 5040	CERAMIC CAP.	0.047uF	50V	F	UP050F473Z-A-B	K28179002		
C 5041	CERAMIC CAP.	0.047uF	50V	F	UP050F473Z-A-B	K28179002		
C 5042	CERAMIC CAP.	68pF	500V	SL	DD05-979SL680K500	K26270033		
C 5043	CERAMIC CAP.	27pF	500V	SL	DD05-979SL270K500	K26270023		
C 5044	MICA CAP.	130p	500V		LCQ17131J5	K30275131		
C 5045	CERAMIC CAP.	15pF	500V	SL	DD05-979SL150K500	K26270017		
C 5046	CERAMIC CAP.	75p	500V	SL	DD06-979SL750K500	K26270034		
C 5047	CERAMIC CAP.	0.047uF	50V	F	UP050F473Z-A-B	K28179002		
C 5048	CERAMIC CAP.	220pF	50V	B	UP050B221K-A-B	K28179083		
C 5049	CERAMIC CAP.	0.047uF	50V	F	UP050F473Z-A-B	K28179002		
C 5050	CERAMIC CAP.	0.047uF	50V	F	UP050F473Z-A-B	K28179002		
C 5051	CERAMIC CAP.	0.047uF	50V	F	UP050F473Z-A-B	K28179002		

LPF Unit

REF.	DESCRIPTION	VALUE	WV	TOL.	MFGR'S DESIG	YAESU P/N	VERS.	Addr
C 5052	CERAMIC CAP.	0.047uF	50V	F	UP050F473Z-A-B	K28179002		
C 5053	CERAMIC CAP.	0.047uF	50V	F	UP050F473Z-A-B	K28179002		
C 5054	CERAMIC CAP.	0.047uF	50V	F	UP050F473Z-A-B	K28179002		
C 5055	CERAMIC CAP.	0.047uF	50V	F	UP050F473Z-A-B	K28179002		
D 5001	DIODE				1SS101	G2090223		
D 5002	DIODE				1SS101	G2090223		
D 5003	DIODE				1SS101	G2090223		
D 5004	DIODE				1SS101	G2090223		
D 5005	DIODE				1SS270TJ	G2060004		
D 5006	DIODE				1SS270TJ	G2060004		
D 5007	SURGE ABSORBER				DSP201M-S00B	Q9000375		
J 5001	CONNECTOR				SC25-02WS	P0090621		
J 5002	CONNECTOR				TMP-J01X-A2	P1090255		
J 5003	CONNECTOR				TMP-J01X-A2	P1090255		
J 5004	CONNECTOR				TMP-J01X-A2	P1090255		
J 5005	CONNECTOR				SC25-05WS	P0090624		
J 5006	CONNECTOR				SC25-04WS	P0090623		
L 5001	COIL				3.770U T50-2	L0021405		
L 5002	COIL				2.940U T50-2	L0021406		
L 5003	COIL				1.900U T50-2	L0020615		
L 5004	COIL				2.400U T-50-2	L0021433		
L 5005	COIL				1.100U T50-6	L0020617		
L 5006	COIL				1.320U T50-6	L0020618		
L 5007	COIL				0.65U T50-6	L0022095		
L 5008	COIL				0.460U T50-6	L0021408		
L 5009	COIL				8.0T8.5D0.9UEW R	L0021855		
L 5010	COIL				9.0T8.5D0.9UEW R	L0021856		
L 5011	COIL				6.0T8.0D0.8UEW R	L0021857		
L 5012	COIL				7.0T8.5D0.9UEW R	L0021858		
L 5013	COIL				U 2001F FR9.5	L0021956		
L 5014	M. RFC	1mH			LAL03TA102K	L1790119		
L 5015	M. RFC	1mH			LAL03TA102K	L1790119		
Q 5001	TRANSISTOR				BA1A4M-T	G3050001		
R 5001	METAL FILM RES.	100	1W		ERG-1SJ101P	J22309010		
RL5001	RELAY		DC12V		AG2013	M1190045		
RL5002	RELAY		DC12V		AG2013	M1190045		
RL5003	RELAY		DC12V		AG2013	M1190045		
RL5004	RELAY		DC12V		AG2013	M1190045		
RL5005	RELAY		DC12V		AG2013	M1190045		
RL5006	RELAY		DC12V		AG2013	M1190045		
RL5007	RELAY		DC12V		AG2013	M1190045		
RL5008	RELAY		DC12V		AG2013	M1190045		
RL5009	RELAY		DC12V		AG2013	M1190045		
RL5010	RELAY		DC12V		AG2013	M1190045		
RL5011	RELAY		DC12V		AG2013	M1190045		
RL5012	RELAY		DC12V		AG2013	M1190045		
RL5013	RELAY		DC12V		AG2023	M1190102		
RL5014	RELAY		DC12V		AE5343	M1190005		
TC5001	TRIMMER CAP.	20p			ECV1ZW20X32	K91000013		
TH5001	THERMISTOR				SDT1000	G9090011		

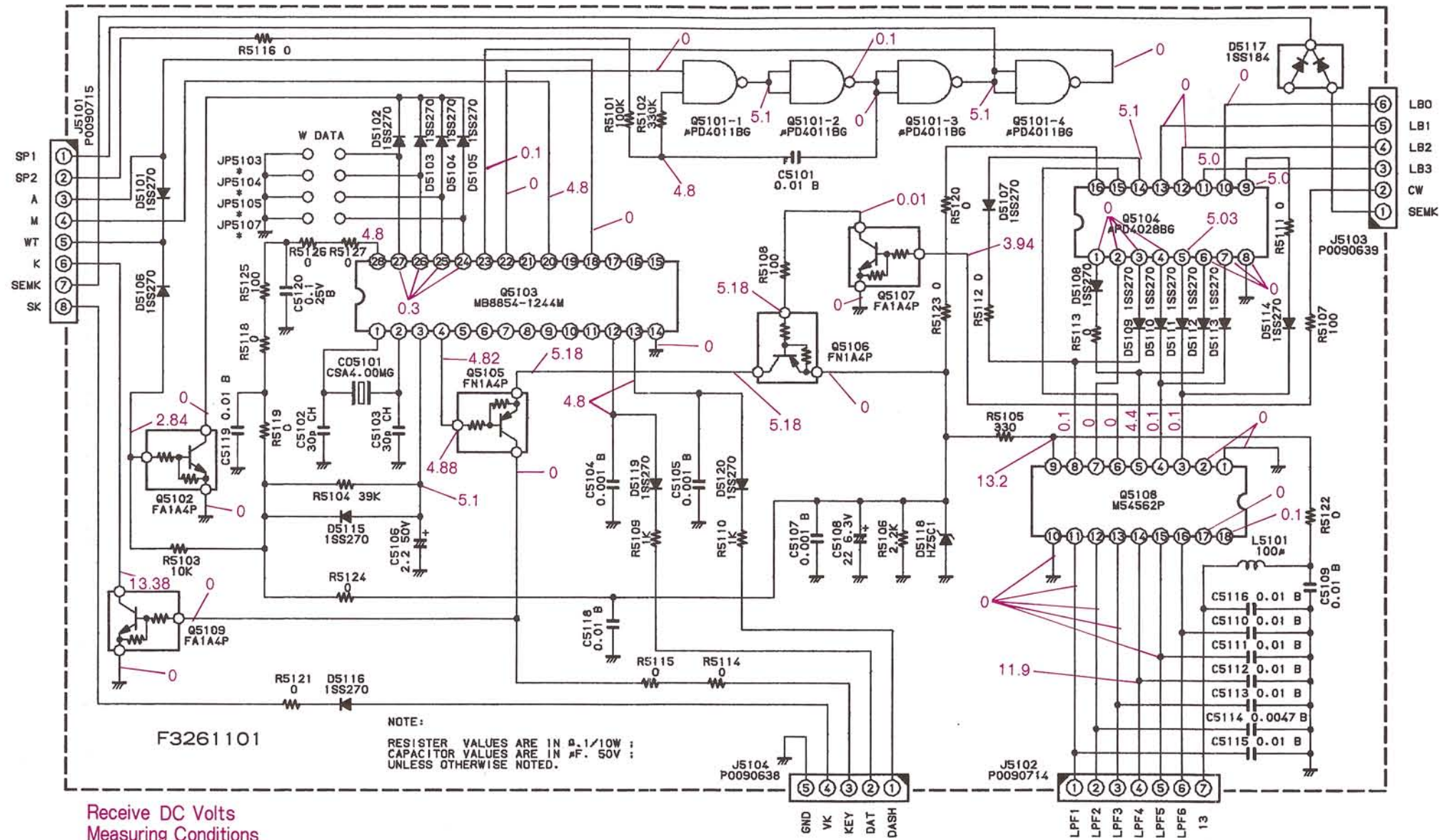

Receive DC Volts
 Measuring Conditions
 Frequency : 14.2MHz
 Break-in Switch: Full
 Keyer Switch: AUTO
 Mode: CW

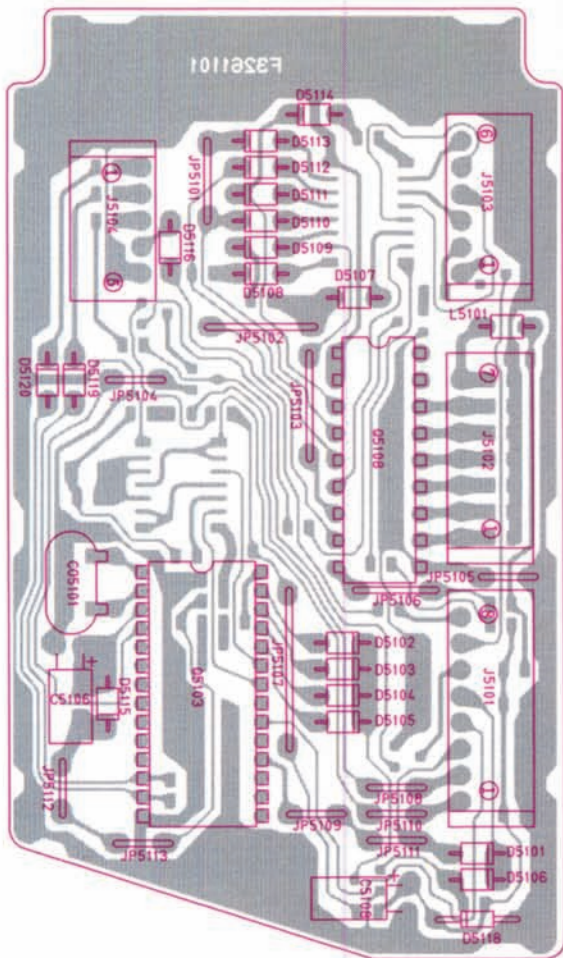

“component” side

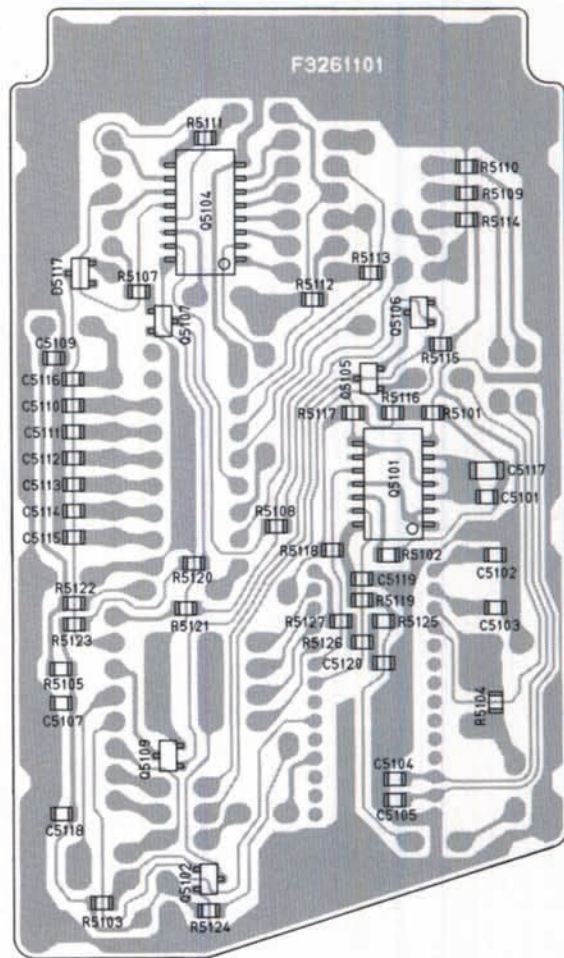

“chip-only” side

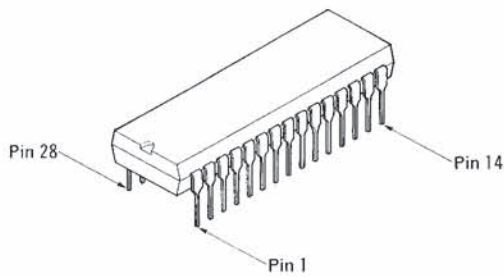

MB8854-1244M
(Q5103)

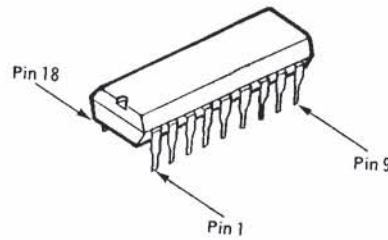

M54562P
(Q5108)

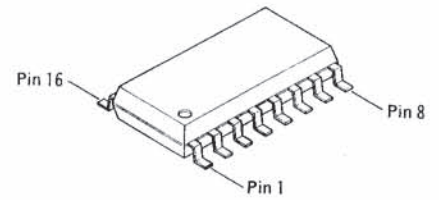

μPD4028BG
(Q5104)

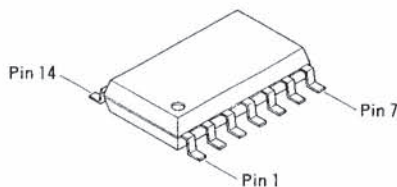

μPD4011BG
(Q5101)

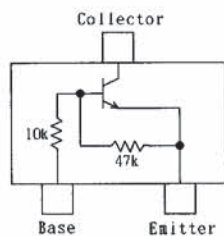

FA1A4P (L34)
(Q5102, 5107, 5109)

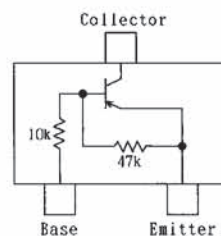

FN1A4P (M34)
(Q5105, 5106)

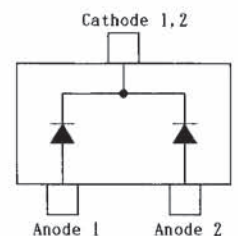

1SS184 (B3)
(D5117)

Keyer Unit

REF.	DESCRIPTION	VALUE	WV	TOL.	MFGR'S DESIG	YAESU P/N	VERS.	Addr
*** KEYER UNIT ***								
	PCB W COMP.					CA0444001		
	PCB W/O COMP.					F3261101		
C 5101	CHIP CAP.	0.01uF	50V	B	GRM40B103M50PT	K22170817		
C 5102	CHIP CAP.	30p	50V	CH	GRM40CH300J50PT	K22170222		
C 5103	CHIP CAP.	30p	50V	CH	GRM40CH300J50PT	K22170222		
C 5104	CHIP CAP.	0.001uF	50V	B	GRM40B102M50PT	K22170805		
C 5105	CHIP CAP.	0.001uF	50V	B	GRM40B102M50PT	K22170805		
C 5106	AL. ELECTRO. CAP.	2.2uF	50V		RC2-50V2R2M	K40179006		
C 5107	CHIP CAP.	0.001uF	50V	B	GRM40B102M50PT	K22170805		
C 5108	AL. ELECTRO. CAP.	22uF	6.3V		RC2-6V220M	K40089005		
C 5109	CHIP CAP.	0.01uF	50V	B	GRM40B103M50PT	K22170817		
C 5110	CHIP CAP.	0.01uF	50V	B	GRM40B103M50PT	K22170817		
C 5111	CHIP CAP.	0.01uF	50V	B	GRM40B103M50PT	K22170817		
C 5112	CHIP CAP.	0.01uF	50V	B	GRM40B103M50PT	K22170817		
C 5113	CHIP CAP.	0.01uF	50V	B	GRM40B103M50PT	K22170817		
C 5114	CHIP CAP.	0.0047uF	50V	B	GRM39B472M50PT	K22174817		
C 5115	CHIP CAP.	0.01uF	50V	B	GRM40B103M50PT	K22170817		
C 5116	CHIP CAP.	0.01uF	50V	B	GRM40B103M50PT	K22170817		
C 5118	CHIP CAP.	0.01uF	50V	B	GRM40B103M50PT	K22170817		
C 5119	CHIP CAP.	0.01uF	50V	B	GRM40B103M50PT	K22170817		
C 5120	CHIP CAP.	0.1uF	25V	B	GRM40B104M25PT	K22140811		
C05101	CERAMIC OSC				CSA4.00MG5	H7900170		
D 5101	DIODE				1SS270TJ	G2060004		
D 5102	DIODE				1SS270TJ	G2060004		
D 5103	DIODE				1SS270TJ	G2060004		
D 5104	DIODE				1SS270TJ	G2060004		
D 5105	DIODE				1SS270TJ	G2060004		
D 5106	DIODE				1SS270TJ	G2060004		
D 5107	DIODE				1SS270TJ	G2060004		
D 5108	DIODE				1SS270TJ	G2060004		
D 5109	DIODE				1SS270TJ	G2060004		
D 5110	DIODE				1SS270TJ	G2060004		
D 5111	DIODE				1SS270TJ	G2060004		
D 5112	DIODE				1SS270TJ	G2060004		
D 5113	DIODE				1SS270TJ	G2060004		
D 5114	DIODE				1SS270TJ	G2060004		
D 5115	DIODE				1SS270TJ	G2060004		
D 5116	DIODE				1SS270TJ	G2060004		
D 5117	DIODE				1SS184 TE85R	G2070009		
D 5118	DIODE				HZ5C1	G2090188		
D 5119	DIODE				1SS270TJ	G2060004		
D 5120	DIODE				1SS270TJ	G2060004		
J 5101	CONNECTOR				SC25-08WL	P0090715		
J 5102	CONNECTOR				SC25-07WL	P0090714		
J 5103	CONNECTOR				SC25-06WL	P0090639		
J 5104	CONNECTOR				SC25-05WL	P0090638		
L 5101	M. RFC	100uH			LAP02TA101K	L1790070		

Keyer Unit

REF.	DESCRIPTION	VALUE	WV	TOL.	MFGR'S DESIG	YAESU P/N	VERS.	Addr
Q 5101	IC				UPD4011BG	G1090600		
Q 5102	TRANSISTOR				FA1A4P-T2B	G3070006		
Q 5103	IC				MB8854-1244M	G1090999		
Q 5104	IC				UPD4028BG-T2	G1091137		
Q 5105	TRANSISTOR				FN1A4P-T2B	G3070011		
Q 5106	TRANSISTOR				FN1A4P-T2B	G3070011		
Q 5107	TRANSISTOR				FA1A4P-T2B	G3070006		
Q 5108	IC				M54562P	G1091196		
Q 5109	TRANSISTOR				FA1A4P-T2B	G3070006		
R 5101	CHIP RES.	100K	1/10W		RMC1/10T 104J	J24205104		
R 5102	CHIP RES.	330K	1/10W		RMC1/10T 334J	J24205334		
R 5103	CHIP RES.	10K	1/10W		RMC1/10T 103J	J24205103		
R 5104	CHIP RES.	39K	1/10W		RMC1/10T 393J	J24205393		
R 5105	CHIP RES.	330	1/10W		RMC1/10T 331J	J24205331		
R 5106	CHIP RES.	2.2K	1/10W		RMC1/10T 222J	J24205222		
R 5107	CHIP RES.	100	1/10W		RMC1/10T 101J	J24205101		
R 5108	CHIP RES.	100	1/10W		RMC1/10T 101J	J24205101		
R 5109	CHIP RES.	1K	1/10W		RMC1/10T 102J	J24205102		
R 5110	CHIP RES.	1K	1/10W		RMC1/10T 102J	J24205102		
R 5111	CHIP RES.	0	1/10W		RMC1/10T 000J	J24205000		
R 5112	CHIP RES.	0	1/10W		RMC1/10T 000J	J24205000		
R 5113	CHIP RES.	0	1/10W		RMC1/10T 000J	J24205000		
R 5114	CHIP RES.	0	1/10W		RMC1/10T 000J	J24205000		
R 5115	CHIP RES.	0	1/10W		RMC1/10T 000J	J24205000		
R 5116	CHIP RES.	0	1/10W		RMC1/10T 000J	J24205000		
R 5118	CHIP RES.	0	1/10W		RMC1/10T 000J	J24205000		
R 5119	CHIP RES.	0	1/10W		RMC1/10T 000J	J24205000		
R 5120	CHIP RES.	0	1/10W		RMC1/10T 000J	J24205000		
R 5121	CHIP RES.	0	1/10W		RMC1/10T 000J	J24205000		
R 5122	CHIP RES.	0	1/10W		RMC1/10T 000J	J24205000		
R 5123	CHIP RES.	0	1/10W		RMC1/10T 000J	J24205000		
R 5124	CHIP RES.	0	1/10W		RMC1/10T 000J	J24205000		
R 5125	CHIP RES.	100	1/10W		RMC1/10T 101J	J24205101		
R 5126	CHIP RES.	0	1/10W		RMC1/10T 000J	J24205000		
R 5127	CHIP RES.	0	1/10W		RMC1/10T 000J	J24205000		

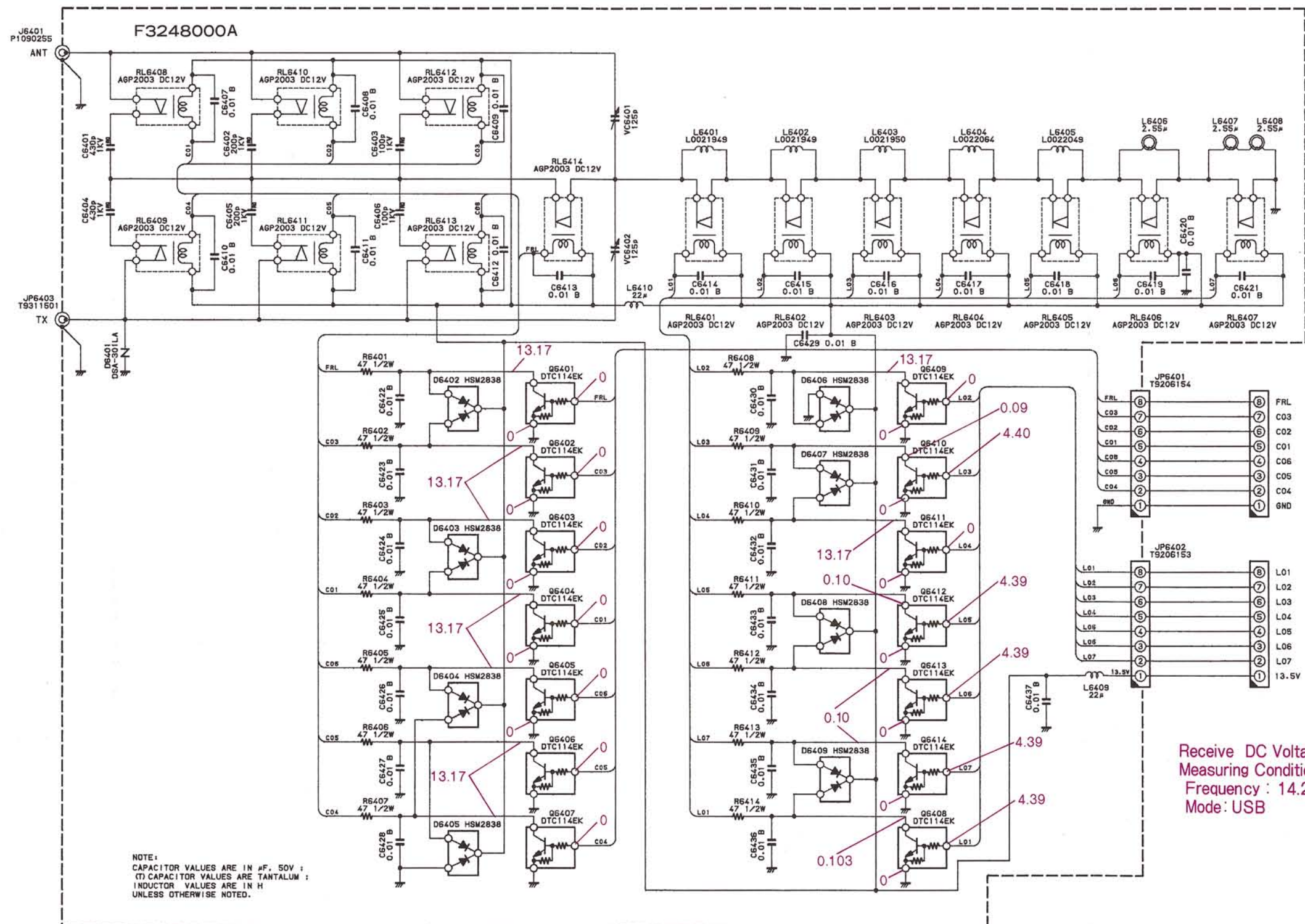

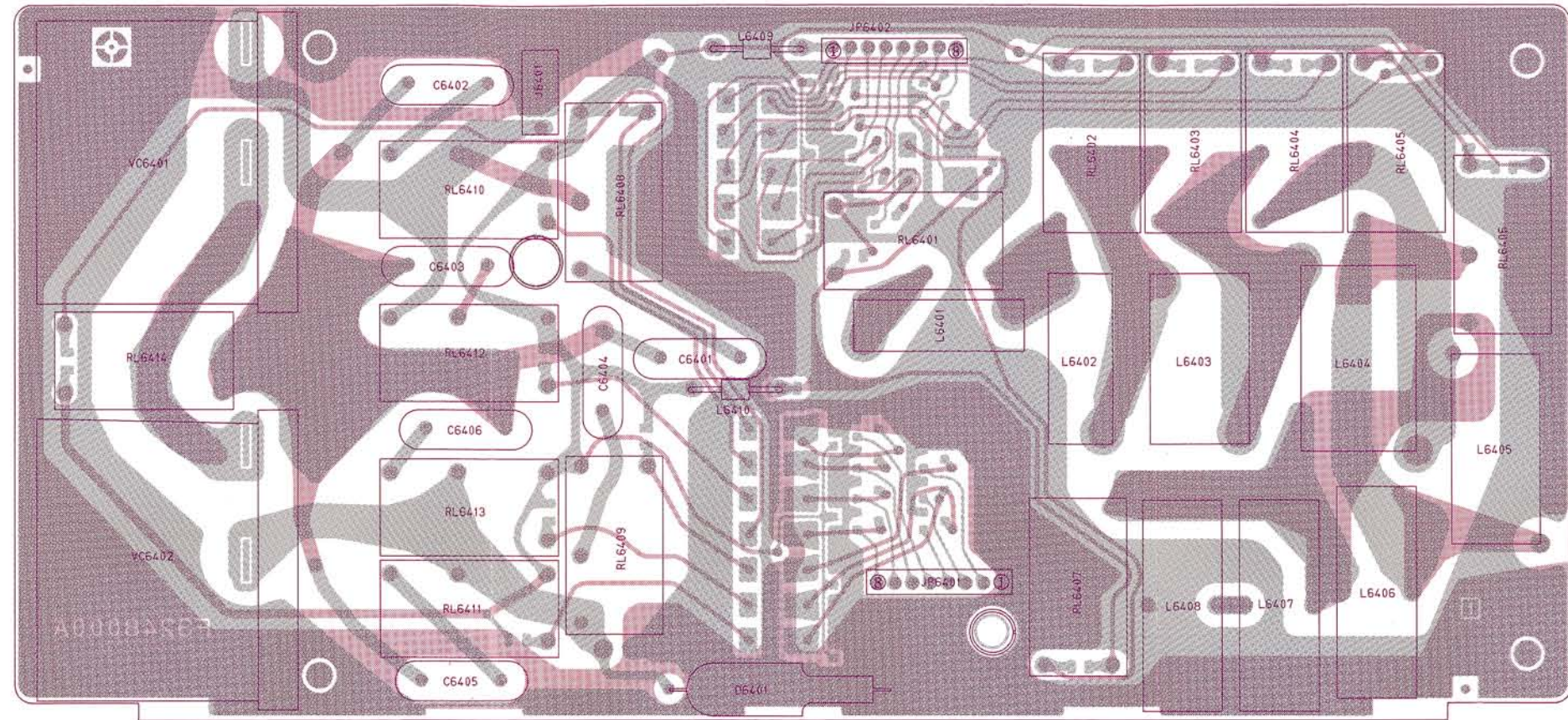

"component" side

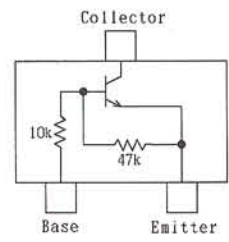

DTC114EK (24)
 Q6401, 6402, 6403
 6404, 6405, 6406
 6407, 6408, 6414

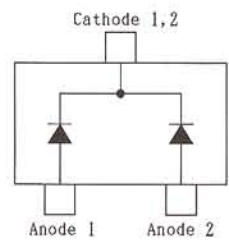

HSM2838 (A6)
 D6402, 6403, 6404
 6405, 6406, 6407
 6408, 6409

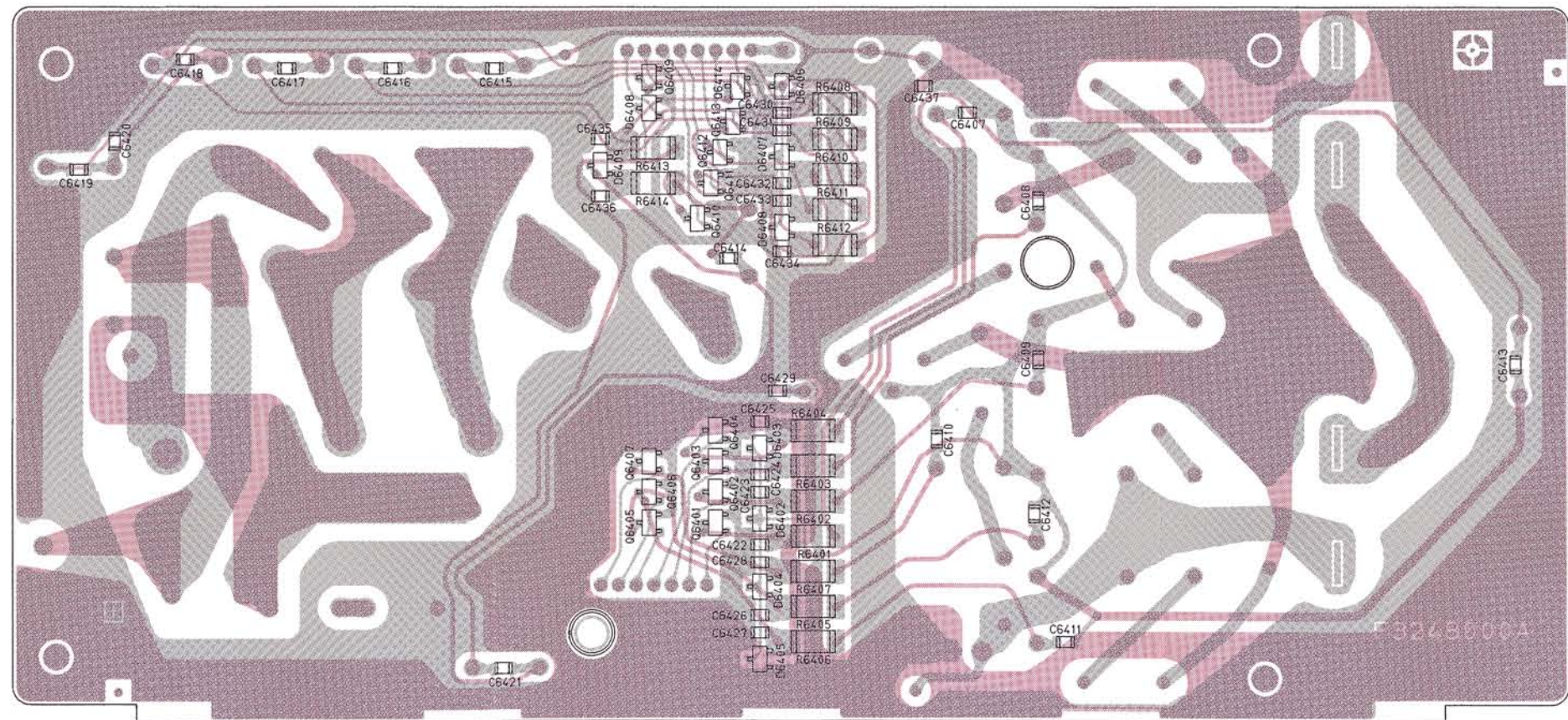

"chip-only" side

Tuner Main Unit

REF.	DESCRIPTION	VALUE	WV	TOL.	MFGR'S DESIG	YAESU P/N	VERS.	Addr
*** TUNER-MAIN UNIT ***								
	PCB W COMP.					CA0397001		
	TUNER MAIN, TUNER CNTL UNIT W COMP.					CP3584001		
	PCB W/O COMP.					F3248000A		
C 6401	MICA CAP.	430p	1KV		DML2 431J10	K30309018		
C 6402	MICA CAP.	200p	1KV		DML2 201J10	K30309026		
C 6403	MICA CAP.	100pF	1KV		DML2 101J10	K30309040		
C 6404	MICA CAP.	430p	1KV		DML2 431J10	K30309018		
C 6405	MICA CAP.	200p	1KV		DML2 201J10	K30309026		
C 6406	MICA CAP.	100pF	1KV		DML2 101J10	K30309040		
C 6407	CHIP CAP.	0.01uF	50V	B	GRM40B103M50PT	K22170817		
C 6408	CHIP CAP.	0.01uF	50V	B	GRM40B103M50PT	K22170817		
C 6409	CHIP CAP.	0.01uF	50V	B	GRM40B103M50PT	K22170817		
C 6410	CHIP CAP.	0.01uF	50V	B	GRM40B103M50PT	K22170817		
C 6411	CHIP CAP.	0.01uF	50V	B	GRM40B103M50PT	K22170817		
C 6412	CHIP CAP.	0.01uF	50V	B	GRM40B103M50PT	K22170817		
C 6413	CHIP CAP.	0.01uF	50V	B	GRM40B103M50PT	K22170817		
C 6414	CHIP CAP.	0.01uF	50V	B	GRM40B103M50PT	K22170817		
C 6415	CHIP CAP.	0.01uF	50V	B	GRM40B103M50PT	K22170817		
C 6416	CHIP CAP.	0.01uF	50V	B	GRM40B103M50PT	K22170817		
C 6417	CHIP CAP.	0.01uF	50V	B	GRM40B103M50PT	K22170817		
C 6418	CHIP CAP.	0.01uF	50V	B	GRM40B103M50PT	K22170817		
C 6419	CHIP CAP.	0.01uF	50V	B	GRM40B103M50PT	K22170817		
C 6420	CHIP CAP.	0.01uF	50V	B	GRM40B103M50PT	K22170817		
C 6421	CHIP CAP.	0.01uF	50V	B	GRM40B103M50PT	K22170817		
C 6422	CHIP CAP.	0.01uF	50V	B	GRM40B103M50PT	K22170817		
C 6423	CHIP CAP.	0.01uF	50V	B	GRM40B103M50PT	K22170817		
C 6424	CHIP CAP.	0.01uF	50V	B	GRM40B103M50PT	K22170817		
C 6425	CHIP CAP.	0.01uF	50V	B	GRM40B103M50PT	K22170817		
C 6426	CHIP CAP.	0.01uF	50V	B	GRM40B103M50PT	K22170817		
C 6427	CHIP CAP.	0.01uF	50V	B	GRM40B103M50PT	K22170817		
C 6428	CHIP CAP.	0.01uF	50V	B	GRM40B103M50PT	K22170817		
C 6429	CHIP CAP.	0.01uF	50V	B	GRM40B103M50PT	K22170817		
C 6430	CHIP CAP.	0.01uF	50V	B	GRM40B103M50PT	K22170817		
C 6431	CHIP CAP.	0.01uF	50V	B	GRM40B103M50PT	K22170817		
C 6432	CHIP CAP.	0.01uF	50V	B	GRM40B103M50PT	K22170817		
C 6433	CHIP CAP.	0.01uF	50V	B	GRM40B103M50PT	K22170817		
C 6434	CHIP CAP.	0.01uF	50V	B	GRM40B103M50PT	K22170817		
C 6435	CHIP CAP.	0.01uF	50V	B	GRM40B103M50PT	K22170817		
C 6436	CHIP CAP.	0.01uF	50V	B	GRM40B103M50PT	K22170817		
C 6437	CHIP CAP.	0.01uF	50V	B	GRM40B103M50PT	K22170817		
D 6401	SURGE ABSORBER				DSA-301LA	Q9000371		
D 6402	DIODE				HSM2838-TR	G2070108		
D 6403	DIODE				HSM2838-TR	G2070108		
D 6404	DIODE				HSM2838-TR	G2070108		
D 6405	DIODE				HSM2838-TR	G2070108		
D 6406	DIODE				HSM2838-TR	G2070108		
D 6407	DIODE				HSM2838-TR	G2070108		
D 6408	DIODE				HSM2838-TR	G2070108		
D 6409	DIODE				HSM2838-TR	G2070108		
J 6401	CONNECTOR				TMP-J01X-A2	P1090255		

Tuner Main Unit

REF.	DESCRIPTION	VALUE	WV	TOL.	MFGR'S DESIG	YAESU P/N	VERS.	Addr
JP6401	WIRE-ASSY					T9206154		
JP6402	WIRE-ASSY					T9206153		
JP6403	WIRE-ASSY					T9311501		
L 6401	COIL				2. 5T15D2. OPVF R	L0021949		
L 6402	COIL				2. 5T15D2. OPVF R	L0021949		
L 6403	COIL				4. 5T15D2. OPVF R	L0021950		
L 6404	COIL				6. 5T19D2. OPVF R	L0022064		
L 6405	COIL				7. 5T20D1. 2UEW R	L0022049		
L 6406	COIL	2. 55u			2. 55U T-80-2	L0021978		
L 6407	COIL	2. 55u			2. 55U T-80-2	L0021978		
L 6408	COIL	2. 55u			2. 55U T-80-2	L0021978		
L 6409	M. RFC	22uH			LAL03TA220K	L1790099		
L 6410	M. RFC	22uH			LAL03TA220K	L1790099		
Q 6401	TRANSISTOR				DTC114EK T96	G3070002		
Q 6402	TRANSISTOR				DTC114EK T96	G3070002		
Q 6403	TRANSISTOR				DTC114EK T96	G3070002		
Q 6404	TRANSISTOR				DTC114EK T96	G3070002		
Q 6405	TRANSISTOR				DTC114EK T96	G3070002		
Q 6406	TRANSISTOR				DTC114EK T96	G3070002		
Q 6407	TRANSISTOR				DTC114EK T96	G3070002		
Q 6408	TRANSISTOR				DTC114EK T96	G3070002		
Q 6414	TRANSISTOR				DTC114EK T96	G3070002		
R 6401	CHIP RES.	47	1/2W		RMC1/2 470JCTP	J24275470		
R 6402	CHIP RES.	47	1/2W		RMC1/2 470JCTP	J24275470		
R 6403	CHIP RES.	47	1/2W		RMC1/2 470JCTP	J24275470		
R 6404	CHIP RES.	47	1/2W		RMC1/2 470JCTP	J24275470		
R 6405	CHIP RES.	47	1/2W		RMC1/2 470JCTP	J24275470		
R 6406	CHIP RES.	47	1/2W		RMC1/2 470JCTP	J24275470		
R 6407	CHIP RES.	47	1/2W		RMC1/2 470JCTP	J24275470		
R 6408	CHIP RES.	47	1/2W		RMC1/2 470JCTP	J24275470		
R 6409	CHIP RES.	47	1/2W		RMC1/2 470JCTP	J24275470		
R 6410	CHIP RES.	47	1/2W		RMC1/2 470JCTP	J24275470		
R 6411	CHIP RES.	47	1/2W		RMC1/2 470JCTP	J24275470		
R 6412	CHIP RES.	47	1/2W		RMC1/2 470JCTP	J24275470		
R 6413	CHIP RES.	47	1/2W		RMC1/2 470JCTP	J24275470		
R 6414	CHIP RES.	47	1/2W		RMC1/2 470JCTP	J24275470		
RL6401	RELAY		DC12V		AGP2003	M1190075		
RL6402	RELAY		DC12V		AGP2003	M1190075		
RL6403	RELAY		DC12V		AGP2003	M1190075		
RL6404	RELAY		DC12V		AGP2003	M1190075		
RL6405	RELAY		DC12V		AGP2003	M1190075		
RL6406	RELAY		DC12V		AGP2003	M1190075		
RL6407	RELAY		DC12V		AGP2003	M1190075		
RL6408	RELAY		DC12V		AGP2003	M1190075		
RL6409	RELAY		DC12V		AGP2003	M1190075		
RL6410	RELAY		DC12V		AGP2003	M1190075		
RL6411	RELAY		DC12V		AGP2003	M1190075		
RL6412	RELAY		DC12V		AGP2003	M1190075		
RL6413	RELAY		DC12V		AGP2003	M1190075		
RL6414	RELAY		DC12V		AGP2003	M1190075		
VC6401	TRIMMER CAP.	125p			YV-125-05	K90000049		
VC6402	TRIMMER CAP.	125p			YV-125-05	K90000049		

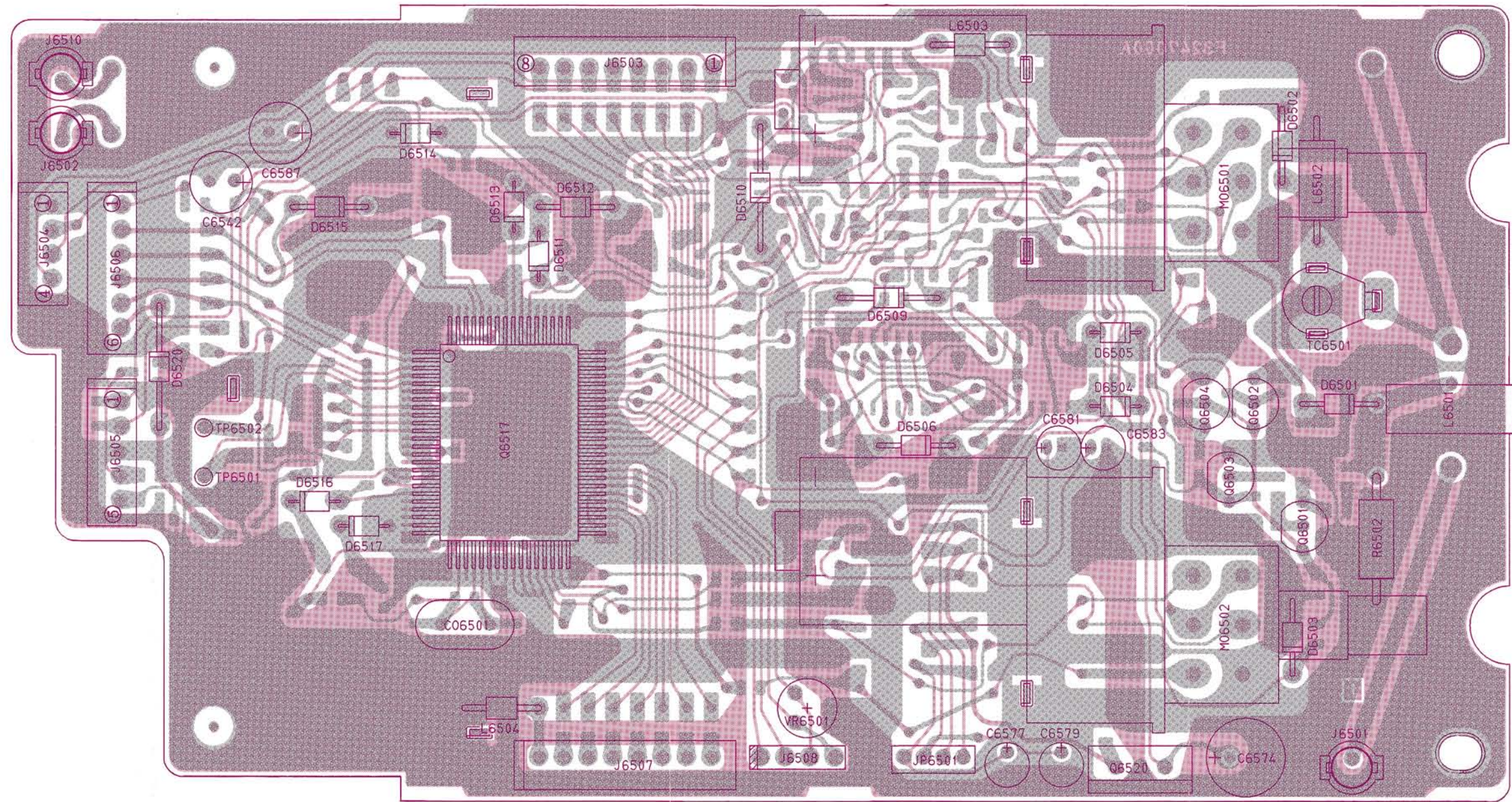

"component" side

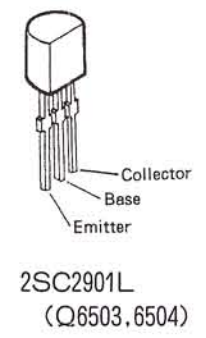
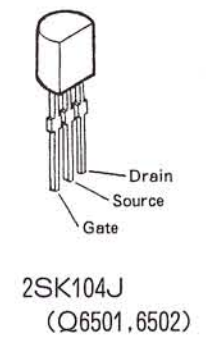
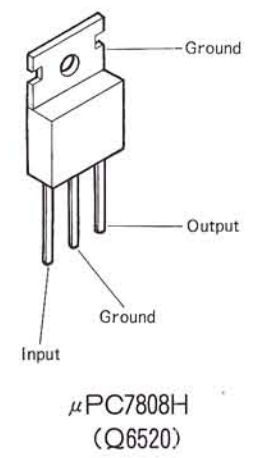
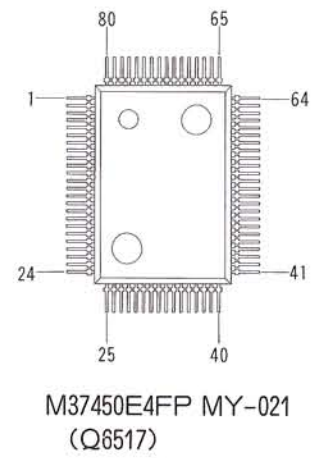

Tuner Control (CNTL) Unit

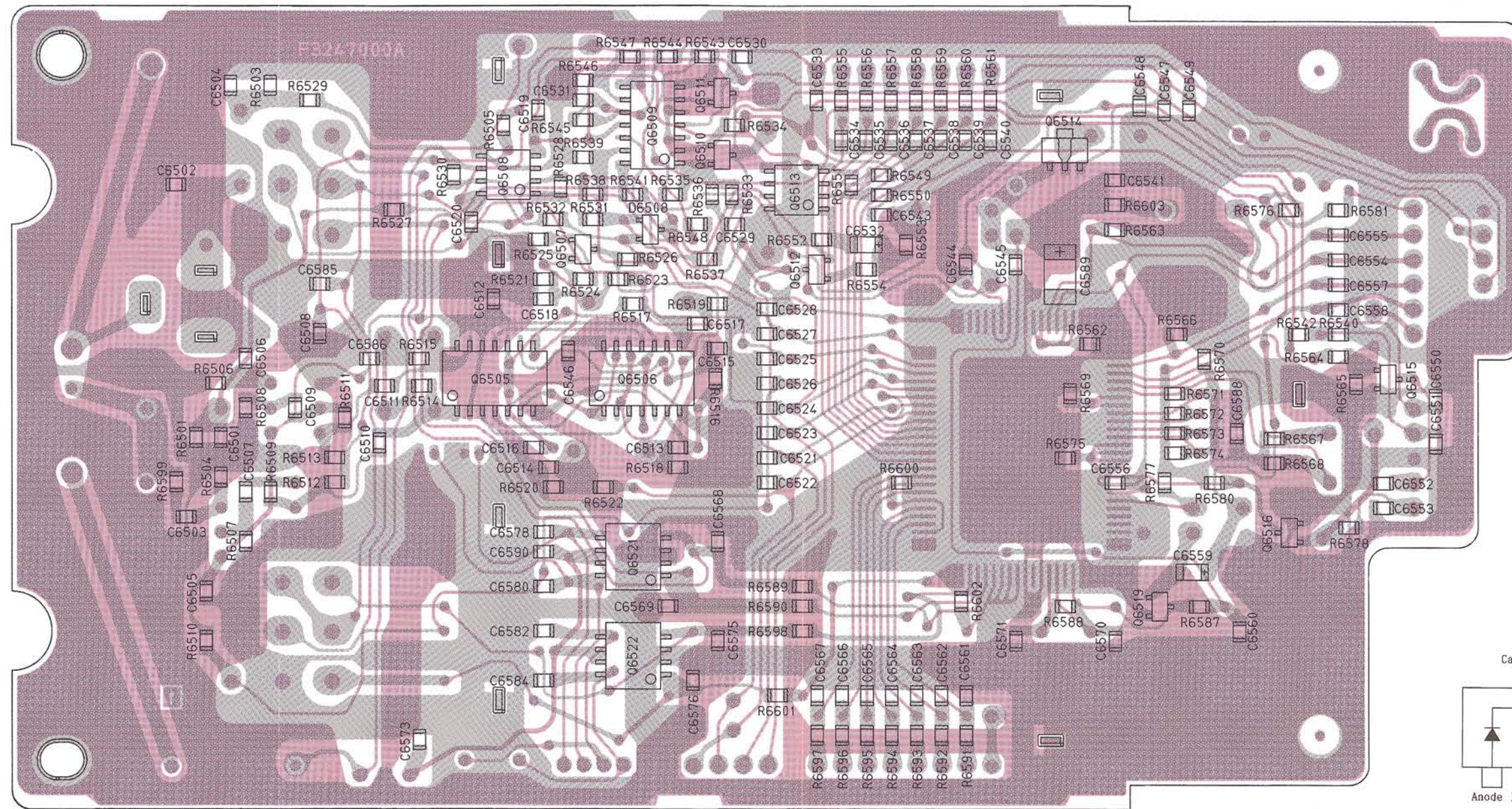

"chip-only" side

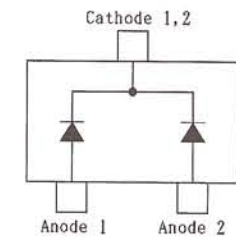

HSM2838 (A6)
(D6508)

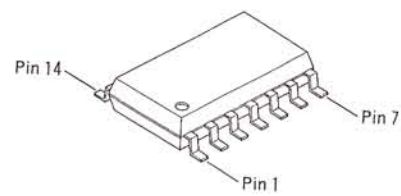

HD74AC00FP (Q6505)
HD74AC74FP (Q6506)
NJM2902M (Q6509)

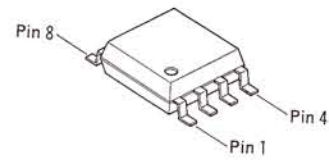

MB3763PF (6521, 6522)
NJM2903M (Q6513)
NJM2904M (Q6508)

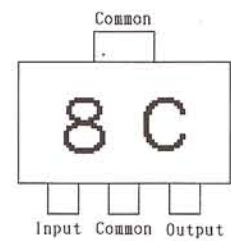

NJM78L05UA (8C)
(Q6514)

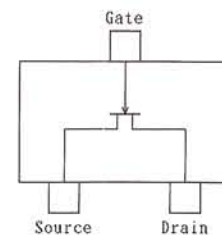

2SK160 (K5)
(Q6510, 6511)

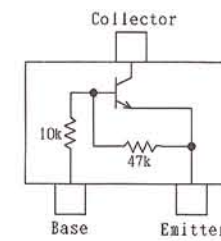

FA1A4P (L34)
(Q6516, 6519)

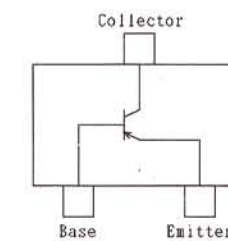

2SA1235 (ME)
(Q6512)

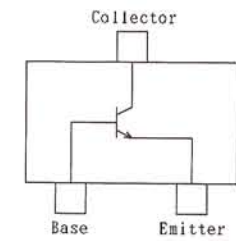

2SC2712GR (LG)
(Q6507, 6515)

Tuner Control (CNTL) Unit

REF.	DESCRIPTION	VALUE	WV	TOL.	MFGR'S DESIG	YAESU P/N	VERS.	Addr
*** TUN-CNTL UNIT ***								
	PCB W COMP.					CA0570001		
	PCB W/O COMP.					F3247000A		
C 6501	CHIP CAP.	0.01uF	50V	B	GRM40B103M50PT	K22170817		
C 6502	CHIP CAP.	220pF	50V	CH	GRM40CH221J50PT	K22170243		
C 6503	CHIP CAP.	0.01uF	50V	B	GRM40B103M50PT	K22170817		
C 6504	CHIP CAP.	0.01uF	50V	B	GRM40B103M50PT	K22170817		
C 6505	CHIP CAP.	0.01uF	50V	B	GRM40B103M50PT	K22170817		
C 6506	CHIP CAP.	0.01uF	50V	B	GRM40B103M50PT	K22170817		
C 6507	CHIP CAP.	0.01uF	50V	B	GRM40B103M50PT	K22170817		
C 6508	CHIP CAP.	0.047uF	50V	F	GRM40F473Z50PT	K22171008		
C 6509	CHIP CAP.	0.01uF	50V	B	GRM40B103M50PT	K22170817		
C 6510	CHIP CAP.	0.01uF	50V	B	GRM40B103M50PT	K22170817		
C 6511	CHIP CAP.	0.01uF	50V	B	GRM40B103M50PT	K22170817		
C 6512	CHIP CAP.	0.01uF	50V	B	GRM40B103M50PT	K22170817		
C 6513	CHIP CAP.	0.047uF	50V	F	GRM40F473Z50PT	K22171008		
C 6514	CHIP CAP.	0.01uF	50V	B	GRM40B103M50PT	K22170817		
C 6515	CHIP CAP.	0.01uF	50V	B	GRM40B103M50PT	K22170817		
C 6516	CHIP CAP.	0.01uF	50V	B	GRM40B103M50PT	K22170817		
C 6517	CHIP CAP.	0.047uF	50V	F	GRM40F473Z50PT	K22171008		
C 6518	CHIP CAP.	0.01uF	50V	B	GRM40B103M50PT	K22170817		
C 6519	CHIP CAP.	0.1uF	25V	B	GRM40B104M25PT	K22140811		
C 6520	CHIP CAP.	0.01uF	50V	B	GRM40B103M50PT	K22170817		
C 6521	CHIP CAP.	0.01uF	50V	B	GRM40B103M50PT	K22170817		
C 6522	CHIP CAP.	0.01uF	50V	B	GRM40B103M50PT	K22170817		
C 6523	CHIP CAP.	0.01uF	50V	B	GRM40B103M50PT	K22170817		
C 6524	CHIP CAP.	0.01uF	50V	B	GRM40B103M50PT	K22170817		
C 6525	CHIP CAP.	0.01uF	50V	B	GRM40B103M50PT	K22170817		
C 6526	CHIP CAP.	0.01uF	50V	B	GRM40B103M50PT	K22170817		
C 6527	CHIP CAP.	0.01uF	50V	B	GRM40B103M50PT	K22170817		
C 6528	CHIP CAP.	0.047uF	50V	F	GRM40F473Z50PT	K22171008		
C 6529	CHIP CAP.	0.047uF	50V	F	GRM40F473Z50PT	K22171008		
C 6530	CHIP CAP.	0.01uF	50V	B	GRM40B103M50PT	K22170817		
C 6531	CHIP CAP.	0.047uF	50V	F	GRM40F473Z50PT	K22171008		
C 6532	TANTALUM CHIP CAP.	1uF	16V		TESVA1C105M1-8R	K78120009		
C 6533	CHIP CAP.	0.01uF	50V	B	GRM40B103M50PT	K22170817		
C 6534	CHIP CAP.	0.01uF	50V	B	GRM40B103M50PT	K22170817		
C 6535	CHIP CAP.	0.01uF	50V	B	GRM40B103M50PT	K22170817		
C 6536	CHIP CAP.	0.01uF	50V	B	GRM40B103M50PT	K22170817		
C 6537	CHIP CAP.	0.01uF	50V	B	GRM40B103M50PT	K22170817		
C 6538	CHIP CAP.	0.01uF	50V	B	GRM40B103M50PT	K22170817		
C 6539	CHIP CAP.	0.01uF	50V	B	GRM40B103M50PT	K22170817		
C 6540	CHIP CAP.	0.01uF	50V	B	GRM40B103M50PT	K22170817		
C 6541	CHIP CAP.	0.01uF	50V	B	GRM40B103M50PT	K22170817		
C 6542	AL. ELECTRO. CAP.	100uF	10V		RC2-10V101M	K40109015		
C 6543	CHIP CAP.	0.047uF	50V	F	GRM40F473Z50PT	K22171008		
C 6544	CHIP CAP.	0.01uF	50V	B	GRM40B103M50PT	K22170817		
C 6545	CHIP CAP.	0.047uF	50V	F	GRM40F473Z50PT	K22171008		
C 6546	CHIP CAP.	0.01uF	50V	B	GRM40B103M50PT	K22170817		
C 6547	CHIP CAP.	0.047uF	50V	F	GRM40F473Z50PT	K22171008		
C 6548	CHIP CAP.	0.047uF	50V	F	GRM40F473Z50PT	K22171008		
C 6549	CHIP CAP.	0.047uF	50V	F	GRM40F473Z50PT	K22171008		
C 6550	CHIP CAP.	0.01uF	50V	B	GRM40B103M50PT	K22170817		

Tuner Control (CNTL) Unit

REF.	DESCRIPTION	VALUE	WV	TOL.	MFGR'S DESIG	YAESU P/N	VERS.	Addr
C 6551	CHIP CAP.	0.01uF	50V	B	GRM40B103M50PT	K22170817		
C 6552	CHIP CAP.	0.01uF	50V	B	GRM40B103M50PT	K22170817		
C 6553	CHIP CAP.	0.01uF	50V	B	GRM40B103M50PT	K22170817		
C 6554	CHIP CAP.	0.01uF	50V	B	GRM40B103M50PT	K22170817		
C 6555	CHIP CAP.	0.01uF	50V	B	GRM40B103M50PT	K22170817		
C 6556	CHIP CAP.	0.0022uF	50V	B	GRM40B222M50PT	K22170809		
C 6557	CHIP CAP.	0.01uF	50V	B	GRM40B103M50PT	K22170817		
C 6558	CHIP CAP.	0.01uF	50V	B	GRM40B103M50PT	K22170817		
C 6559	TANTALUM CHIP CAP.	0.47uF	25V		TESVA1E474M1-8R	K78140009		
C 6560	CHIP CAP.	0.01uF	50V	B	GRM40B103M50PT	K22170817		
C 6561	CHIP CAP.	0.01uF	50V	B	GRM40B103M50PT	K22170817		
C 6562	CHIP CAP.	0.01uF	50V	B	GRM40B103M50PT	K22170817		
C 6563	CHIP CAP.	0.01uF	50V	B	GRM40B103M50PT	K22170817		
C 6564	CHIP CAP.	0.01uF	50V	B	GRM40B103M50PT	K22170817		
C 6565	CHIP CAP.	0.01uF	50V	B	GRM40B103M50PT	K22170817		
C 6566	CHIP CAP.	0.01uF	50V	B	GRM40B103M50PT	K22170817		
C 6567	CHIP CAP.	0.01uF	50V	B	GRM40B103M50PT	K22170817		
C 6568	CHIP CAP.	0.01uF	50V	B	GRM40B103M50PT	K22170817		
C 6569	CHIP CAP.	0.01uF	50V	B	GRM40B103M50PT	K22170817		
C 6570	CHIP CAP.	33pF	50V	RH	GRM40RH330J50PT	K22170523		
C 6571	CHIP CAP.	33pF	50V	RH	GRM40RH330J50PT	K22170523		
C 6573	CHIP CAP.	0.047uF	50V	F	GRM40F473Z50PT	K22171008		
C 6574	AL. ELECTRO. CAP.	330uF	16V		RE2-16V331M	K40129043		
C 6575	CHIP CAP.	0.01uF	50V	B	GRM40B103M50PT	K22170817		
C 6576	CHIP CAP.	0.01uF	50V	B	GRM40B103M50PT	K22170817		
C 6577	AL. ELECTRO. CAP.	10uF	50V		RE2-50V100M	K40179041		
C 6578	CHIP CAP.	0.047uF	50V	F	GRM40F473Z50PT	K22171008		
C 6579	AL. ELECTRO. CAP.	10uF	50V		RE2-50V100M	K40179041		
C 6580	CHIP CAP.	0.047uF	50V	F	GRM40F473Z50PT	K22171008		
C 6581	AL. ELECTRO. CAP.	10uF	16V		RC2-16V100M	K40129012		
C 6582	CHIP CAP.	0.047uF	50V	F	GRM40F473Z50PT	K22171008		
C 6583	AL. ELECTRO. CAP.	10uF	16V		RC2-16V100M	K40129012		
C 6584	CHIP CAP.	0.047uF	50V	F	GRM40F473Z50PT	K22171008		
C 6585	CHIP CAP.	0.047uF	50V	F	GRM40F473Z50PT	K22171008		
C 6586	CHIP CAP.	0.01uF	50V	B	GRM40B103M50PT	K22170817		
C 6587	AL. ELECTRO. CAP.	100uF	10V		RC2-10V101M	K40109015		
C 6588	CHIP CAP.	0.01uF	50V	B	GRM40B103M50PT	K22170817		
C 6589	TANTALUM CHIP CAP.	22uF	6.3V		TESVCOJ226M12R	K78080011		
C 6590	CHIP CAP.	0.01uF	50V	B	GRM40B103M50PT	K22170817		
CO6501	CERAMIC OSC				CSA8.00MT	H7900580		
D 6501	DIODE				1SS101	G2090223		
D 6502	DIODE				1SS101	G2090223		
D 6503	DIODE				RD4.7EB2-T1	G2060006		
D 6504	DIODE				1SS270TJ	G2060004		
D 6505	DIODE				1SS270TJ	G2060004		
D 6506	DIODE				1SS97	G2090118		
D 6508	DIODE				HSM2838-TR	G2070108		
D 6509	DIODE				1SS97	G2090118		
D 6510	DIODE				1SS270TJ	G2060004		
D 6511	DIODE				1SS270TJ	G2060004		
D 6512	DIODE				1SS270TJ	G2060004		
D 6513	DIODE				1SS270TJ	G2060004		
D 6514	DIODE				1SS270TJ	G2060004		
D 6515	DIODE				1SS97	G2090118		

Tuner Control (CNTL) Unit

REF.	DESCRIPTION	VALUE	WV	TOL.	MFGR'S DESIG	YAESU P/N	VERS.	Addr
D 6516	DIODE				1SS270TJ	G2060004		
D 6517	DIODE				1SS270TJ	G2060004		
D 6520	DIODE				1SS270TJ	G2060004		
J 6501	CONNECTOR				TMP-J01X-V6	P1090210		
J 6502	CONNECTOR				TMP-J01X-V6	P1090210		
J 6503	CONNECTOR				SC25-08WS	P0090627		
J 6504	CONNECTOR				SC25-04WS	P0090623		
J 6505	CONNECTOR				SC25-05WS	P0090624		
J 6506	CONNECTOR				SC25-06WS	P0090625		
J 6507	CONNECTOR				SC25-08WS	P0090627		
J 6508	CONNECTOR				3022-04B	P0090523		
J 6510	CONNECTOR				TMP-J01X-V6	P1090210		
JP6501	WIRE-ASSY					T9206156		
JP6502	WIRE-ASSY					T9317880		
JP6503	TMP-PLUG WIRE-ASSY					T9315911A		
L 6501	COIL				U 2001F FR9.5	L0021955		
L 6502	M. RFC	1mH			LAL04NA102K	L1190090		
L 6503	M. RFC	100uH			LAL03TA101K	L1790107		
L 6504	M. RFC	100uH			LAL03TA101K	L1790107		
MO6501	MOTOR POT.	50KB			RK16312MA	Q9000563		
MO6502	MOTOR POT.	50KB			RK16312MA	Q9000563		
Q 6501	FET				2SK104J	G3801040J		
Q 6502	FET				2SK104J	G3801040J		
Q 6503	TRANSISTOR				2SC2901L	G3329010L		
Q 6504	TRANSISTOR				2SC2901L	G3329010L		
Q 6505	IC				HD74AC00FP-TR	G1091226		B3
Q 6506	IC				HD74AC74FP-TR	G1091225		B4
Q 6507	TRANSISTOR				2SC2712GR TE85R	G3327127G		B3
Q 6508	IC				NJM2904M	G1090589		A3
Q 6509	IC				NJM2902M	G1090908		A4
Q 6510	FET				2SK160-T2B K5	G3801607E		A4
Q 6511	FET				2SK160-T2B K5	G3801607E		A4
Q 6512	TRANSISTOR				2SA1235-T14-2E	G3112357E		B4
Q 6513	IC				NJM2903M T2	G1091073		A4
Q 6514	IC				NJM78L05UA TE2	G1091325		A5
Q 6515	TRANSISTOR				2SC2712GR TE85R	G3327127G		B6
Q 6516	TRANSISTOR				FA1A4P-T2B	G3070006		C6
Q 6517	IC				M37450E4FP MY-021	G1091473		
Q 6519	TRANSISTOR				FA1A4P-T2B	G3070006		C6
Q 6520	IC				UPC7808H	G1090294		
Q 6521	IC				MB3763PF-G-BND-TF	G1091224		C4
Q 6522	IC				MB3763PF-G-BND-TF	G1091224		C4
R 6501	CHIP RES.	10K	1/10W		RMC1/10T 103J	J24205103		
R 6502	CARBPM FILM RES.	24	1/2W		RD12TJ240	J01275240		
R 6503	CHIP RES.	10K	1/10W		RMC1/10T 103J	J24205103		
R 6504	CHIP RES.	100K	1/10W		RMC1/10T 104J	J24205104		
R 6505	CHIP RES.	47	1/10W		RMC1/10T 470J	J24205470		
R 6506	CHIP RES.	100K	1/10W		RMC1/10T 104J	J24205104		
R 6507	CHIP RES.	1.5K	1/10W		RMC1/10T 152J	J24205152		
R 6508	CHIP RES.	1.5K	1/10W		RMC1/10T 152J	J24205152		

Tuner Control (CNTL) Unit

REF.	DESCRIPTION	VALUE	WV	TOL.	MFGR'S DESIG	YAESU P/N	VERS.	Addr
R 6509	CHIP RES.	33K	1/10W		RMC1/10T 333J	J24205333		
R 6510	CHIP RES.	1K	1/10W		RMC1/10T 102J	J24205102		
R 6511	CHIP RES.	33K	1/10W		RMC1/10T 333J	J24205333		
R 6512	CHIP RES.	1.5K	1/10W		RMC1/10T 152J	J24205152		
R 6513	CHIP RES.	1.5K	1/10W		RMC1/10T 152J	J24205152		
R 6514	CHIP RES.	100K	1/10W		RMC1/10T 104J	J24205104		
R 6515	CHIP RES.	100K	1/10W		RMC1/10T 104J	J24205104		
R 6516	CHIP RES.	47K	1/10W		RMC1/10T 473J	J24205473		
R 6517	CHIP RES.	47K	1/10W		RMC1/10T 473J	J24205473		
R 6518	CHIP RES.	1K	1/10W		RMC1/10T 102J	J24205102		
R 6519	CHIP RES.	1K	1/10W		RMC1/10T 102J	J24205102		
R 6520	CHIP RES.	100K	1/10W		RMC1/10T 104J	J24205104		
R 6521	CHIP RES.	100K	1/10W		RMC1/10T 104J	J24205104		
R 6522	CHIP RES.	1K	1/10W		RMC1/10T 102J	J24205102		
R 6523	CHIP RES.	1K	1/10W		RMC1/10T 102J	J24205102		
R 6524	CHIP RES.	10K	1/10W		RMC1/10T 103J	J24205103		
R 6525	CHIP RES.	10K	1/10W		RMC1/10T 103J	J24205103		
R 6526	CHIP RES.	10K	1/10W		RMC1/10T 103J	J24205103		
R 6527	CHIP RES.	100K	1/10W		RMC1/10T 104J	J24205104		
R 6528	CHIP RES.	220K	1/10W		RMC1/10T 224J	J24205224		
R 6529	CHIP RES.	100K	1/10W		RMC1/10T 104J	J24205104		
R 6530	CHIP RES.	220K	1/10W		RMC1/10T 224J	J24205224		
R 6531	CHIP RES.	1K	1/10W		RMC1/10T 102J	J24205102		
R 6532	CHIP RES.	1K	1/10W		RMC1/10T 102J	J24205102		
R 6533	CHIP RES.	100K	1/10W		RMC1/10T 104J	J24205104		
R 6534	CHIP RES.	1M	1/10W		RMC1/10T 105J	J24205105		
R 6535	CHIP RES.	220K	1/10W		RMC1/10T 224J	J24205224		
R 6536	CHIP RES.	100K	1/10W		RMC1/10T 104J	J24205104		
R 6537	CHIP RES.	10K	1/10W		RMC1/10T 103J	J24205103		
R 6538	CHIP RES.	47K	1/10W		RMC1/10T 473J	J24205473		
R 6539	CHIP RES.	4.7K	1/10W		RMC1/10T 472J	J24205472		
R 6540	CHIP RES.	2.2M	1/10W		RMC1/10T 225J	J24205225		
R 6541	CHIP RES.	47K	1/10W		RMC1/10T 473J	J24205473		
R 6542	CHIP RES.	1M	1/10W		RMC1/10T 105J	J24205105		
R 6543	CHIP RES.	220K	1/10W		RMC1/10T 224J	J24205224		
R 6544	CHIP RES.	100K	1/10W		RMC1/10T 104J	J24205104		
R 6545	CHIP RES.	10K	1/10W		RMC1/10T 103J	J24205103		
R 6546	CHIP RES.	4.7K	1/10W		RMC1/10T 472J	J24205472		
R 6547	CHIP RES.	47K	1/10W		RMC1/10T 473J	J24205473		
R 6548	CHIP RES.	10K	1/10W		RMC1/10T 103J	J24205103		
R 6549	CHIP RES.	2.2M	1/10W		RMC1/10T 225J	J24205225		
R 6550	CHIP RES.	10K	1/10W		RMC1/10T 103J	J24205103		
R 6551	CHIP RES.	33K	1/10W		RMC1/10T 333J	J24205333		
R 6552	CHIP RES.	10K	1/10W		RMC1/10T 103J	J24205103		
R 6553	CHIP RES.	22K	1/10W		RMC1/10T 223J	J24205223		
R 6554	CHIP RES.	10K	1/10W		RMC1/10T 103J	J24205103		
R 6555	CHIP RES.	1K	1/10W		RMC1/10T 102J	J24205102		
R 6556	CHIP RES.	1K	1/10W		RMC1/10T 102J	J24205102		
R 6557	CHIP RES.	1K	1/10W		RMC1/10T 102J	J24205102		
R 6558	CHIP RES.	1K	1/10W		RMC1/10T 102J	J24205102		
R 6559	CHIP RES.	1K	1/10W		RMC1/10T 102J	J24205102		
R 6560	CHIP RES.	1K	1/10W		RMC1/10T 102J	J24205102		
R 6561	CHIP RES.	1K	1/10W		RMC1/10T 102J	J24205102		
R 6562	CHIP RES.	100K	1/10W		RMC1/10T 104J	J24205104		
R 6563	CHIP RES.	100K	1/10W		RMC1/10T 104J	J24205104		
R 6564	CHIP RES.	10K	1/10W		RMC1/10T 103J	J24205103		

Tuner Control (CNTL) Unit

REF.	DESCRIPTION	VALUE	WV	TOL.	MFGR'S DESIG	YAESU P/N	VERS.	Addr
R 6565	CHIP RES.	10K	1/10W		RMC1/10T 103J	J24205103		
R 6566	CHIP RES.	100K	1/10W		RMC1/10T 104J	J24205104		
R 6567	CHIP RES.	100K	1/10W		RMC1/10T 104J	J24205104		
R 6568	CHIP RES.	100K	1/10W		RMC1/10T 104J	J24205104		
R 6569	CHIP RES.	100K	1/10W		RMC1/10T 104J	J24205104		
R 6570	CHIP RES.	4.7K	1/10W		RMC1/10T 472J	J24205472		
R 6571	CHIP RES.	100K	1/10W		RMC1/10T 104J	J24205104		
R 6572	CHIP RES.	100K	1/10W		RMC1/10T 104J	J24205104		
R 6573	CHIP RES.	100K	1/10W		RMC1/10T 104J	J24205104		
R 6574	CHIP RES.	100K	1/10W		RMC1/10T 104J	J24205104		
R 6575	CHIP RES.	100K	1/10W		RMC1/10T 104J	J24205104		
R 6576	CHIP RES.	100K	1/10W		RMC1/10T 104J	J24205104		
R 6577	CHIP RES.	100K	1/10W		RMC1/10T 104J	J24205104		
R 6578	CHIP RES.	10K	1/10W		RMC1/10T 103J	J24205103		
R 6580	CHIP RES.	10K	1/10W		RMC1/10T 103J	J24205103		
R 6581	CHIP RES.	1K	1/10W		RMC1/10T 102J	J24205102		
R 6587	CHIP RES.	4.7K	1/10W		RMC1/10T 472J	J24205472		
R 6588	CHIP RES.	1M	1/10W		RMC1/10T 105J	J24205105		
R 6589	CHIP RES.	1K	1/10W		RMC1/10T 102J	J24205102		
R 6590	CHIP RES.	1K	1/10W		RMC1/10T 102J	J24205102		
R 6591	CHIP RES.	1K	1/10W		RMC1/10T 102J	J24205102		
R 6592	CHIP RES.	1K	1/10W		RMC1/10T 102J	J24205102		
R 6593	CHIP RES.	1K	1/10W		RMC1/10T 102J	J24205102		
R 6594	CHIP RES.	1K	1/10W		RMC1/10T 102J	J24205102		
R 6595	CHIP RES.	1K	1/10W		RMC1/10T 102J	J24205102		
R 6596	CHIP RES.	1K	1/10W		RMC1/10T 102J	J24205102		
R 6597	CHIP RES.	1K	1/10W		RMC1/10T 102J	J24205102		
R 6598	CHIP RES.	1K	1/10W		RMC1/10T 102J	J24205102		
R 6599	CHIP RES.	180	1/10W		RMC1/10T 181J	J24205181		
R 6600	CHIP RES.	100K	1/10W		RMC1/10T 104J	J24205104		
R 6601	CHIP RES.	1K	1/10W		RMC1/10T 102J	J24205102		
R 6602	CHIP RES.	100K	1/10W		RMC1/10T 104J	J24205104		
R 6603	CHIP RES.	10K	1/10W		RMC1/10T 103J	J24205103		
TC6501	TRIMMER CAP.	10pF			ECV1ZW10X32	K91000012		
TP6501	TP-E/				TP-E/MS-60124	Q5000016		
TP6502	TP-E/				TP-E/MS-60124	Q5000016		
VR6501	POT.	47KB			H0651A017-47KB	J51745473		

Notes

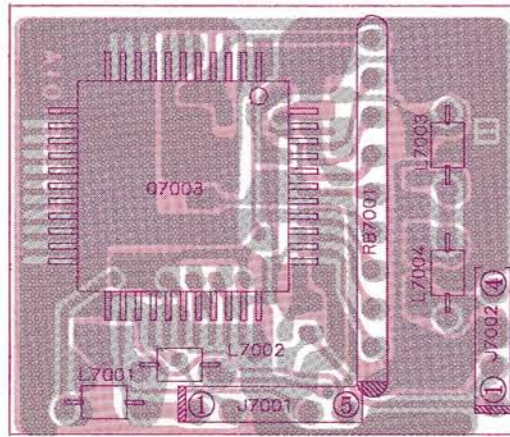

"component" side

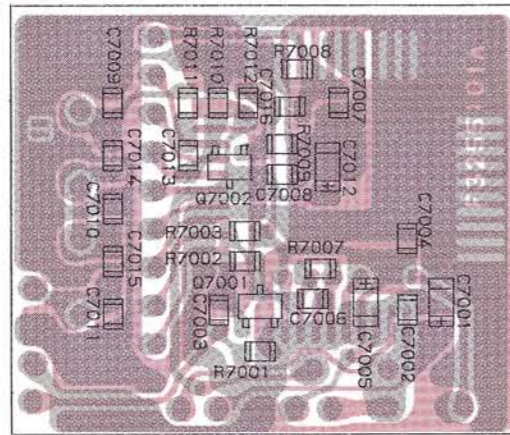

"chip-only" side

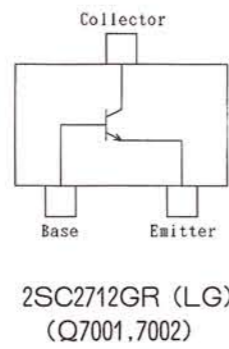
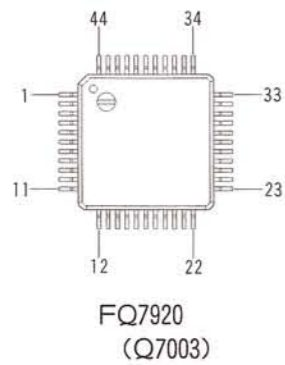
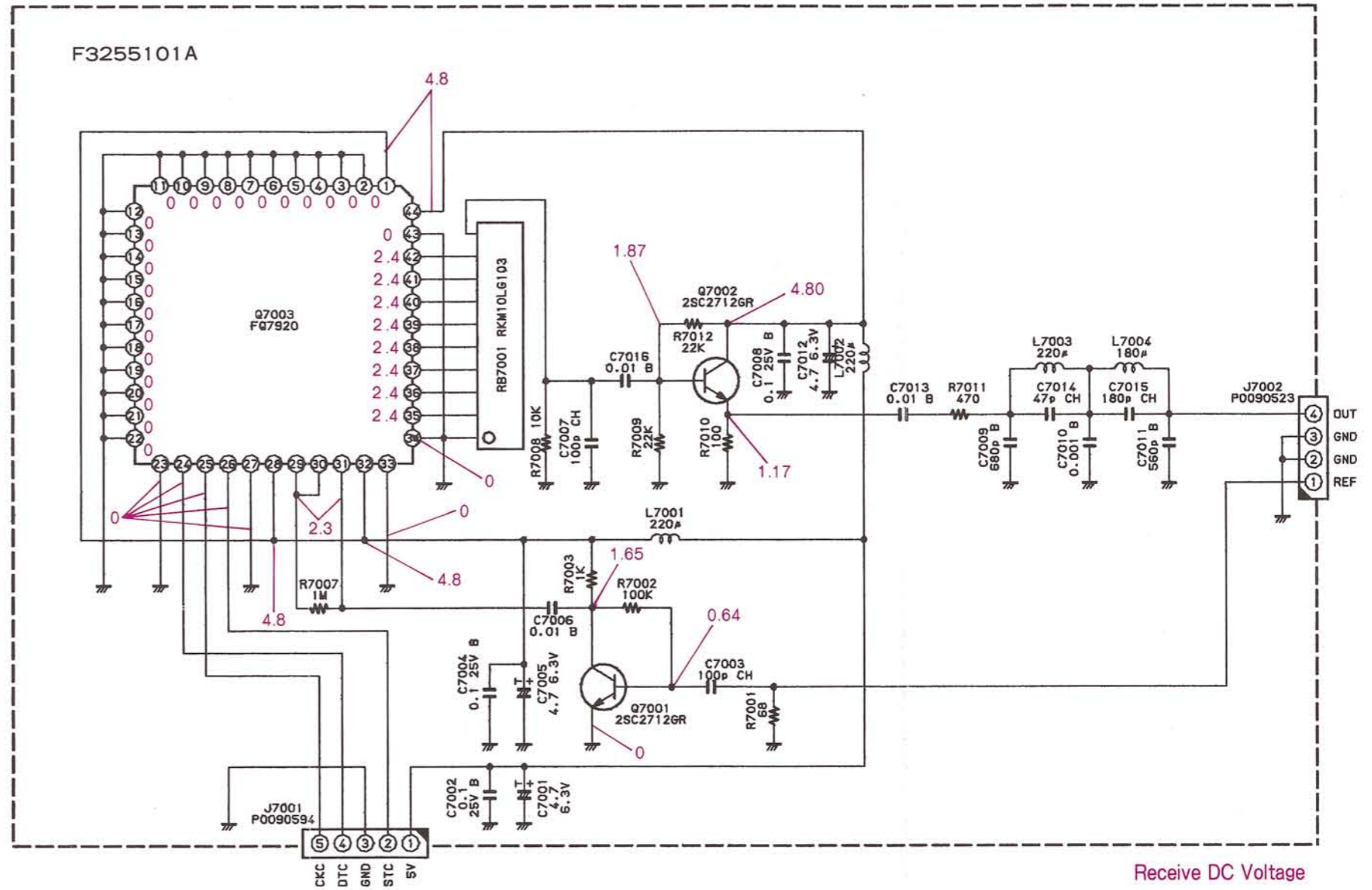

Carrier (CAR) DDS Unit

REF.	DESCRIPTION	VALUE	WV	TOL.	MFR'S DESIG	YAESU P/N	VERS.	Addr
*** CAR-DDS UNIT ***								
	PCB W COMP.					CA0490001		
	PCB W/O COMP.					F3255101A		
C 7001	TANTALUM CHIP CAP.	4.7uF	6.3V		TEMSVA0J475M-8R	K78080017		
C 7002	CHIP CAP.	0.1uF	25V	B	GRM40B104M25PT	K22140811		
C 7003	CHIP CAP.	100pF	50V	CH	GRM40CH101J50PT	K22170235		
C 7004	CHIP CAP.	0.1uF	25V	B	GRM40B104M25PT	K22140811		
C 7005	TANTALUM CHIP CAP.	4.7uF	6.3V		TEMSVA0J475M-8R	K78080017		
C 7006	CHIP CAP.	0.01uF	50V	B	GRM40B103M50PT	K22170817		
C 7007	CHIP CAP.	100pF	50V	CH	GRM40CH101J50PT	K22170235		
C 7008	CHIP CAP.	0.1uF	25V	B	GRM40B104M25PT	K22140811		
C 7009	CHIP CAP.	680pF	50V	B	GRM40B681M50PT	K22170803		
C 7010	CHIP CAP.	0.001uF	50V	B	GRM40B102M50PT	K22170805		
C 7011	CHIP CAP.	560pF	50V	B	GRM40B561M50PT	K22170802		
C 7012	TANTALUM CHIP CAP.	4.7uF	6.3V		TEMSVA0J475M-8R	K78080017		
C 7013	CHIP CAP.	0.01uF	50V	B	GRM40B103M50PT	K22170817		
C 7014	CHIP CAP.	47pF	50V	CH	GRM40CH470J50PT	K22170227		
C 7015	CHIP CAP.	180pF	50V	CH	GRM40CH181J50PT	K22170241		
C 7016	CHIP CAP.	0.01uF	50V	B	GRM40B103M50PT	K22170817		
J 7001	CONNECTOR				3022-05B	P0090594		
J 7002	CONNECTOR				3022-04B	P0090523		
L 7001	M. RFC	220uH			LAP02TA221K	L1790074		
L 7002	M. RFC	220uH			LAP02TA221K	L1790074		
L 7003	M. RFC	220uH			LAP02TA221K	L1790074		
L 7004	M. RFC	180uH			LAP02TA181K	L1790073		
Q 7001	TRANSISTOR				2SC2712GR TE85R	G3327127G		
Q 7002	TRANSISTOR				2SC2712GR TE85R	G3327127G		
Q 7003	IC				FQ7920 (CF77399FS)	G1090952		
R 7001	CHIP RES.	68	1/10W		RMC1/10T 680J	J24205680		
R 7002	CHIP RES.	100K	1/10W		RMC1/10T 104J	J24205104		
R 7003	CHIP RES.	1K	1/10W		RMC1/10T 102J	J24205102		
R 7007	CHIP RES.	1M	1/10W		RMC1/10T 105J	J24205105		
R 7008	CHIP RES.	10K	1/10W		RMC1/10T 103J	J24205103		
R 7009	CHIP RES.	22K	1/10W		RMC1/10T 223J	J24205223		
R 7010	CHIP RES.	100	1/10W		RMC1/10T 101J	J24205101		
R 7011	CHIP RES.	470	1/10W		RMC1/10T 471J	J24205471		
R 7012	CHIP RES.	22K	1/10W		RMC1/10T 223J	J24205223		
RB7001	BLOCK RES.	RKM10LG103			RKM10LG103	J40900170		

Notes

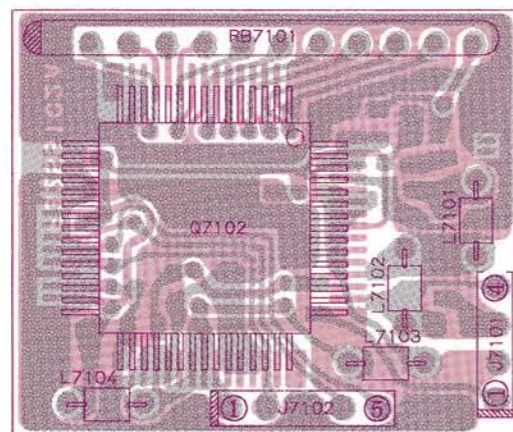

"component" side

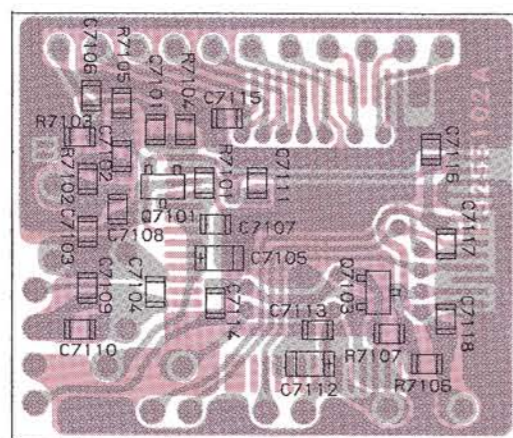

"chip-only" side

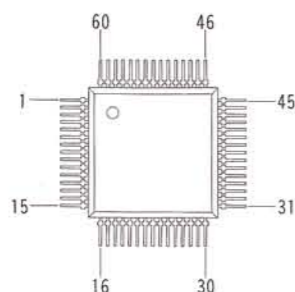
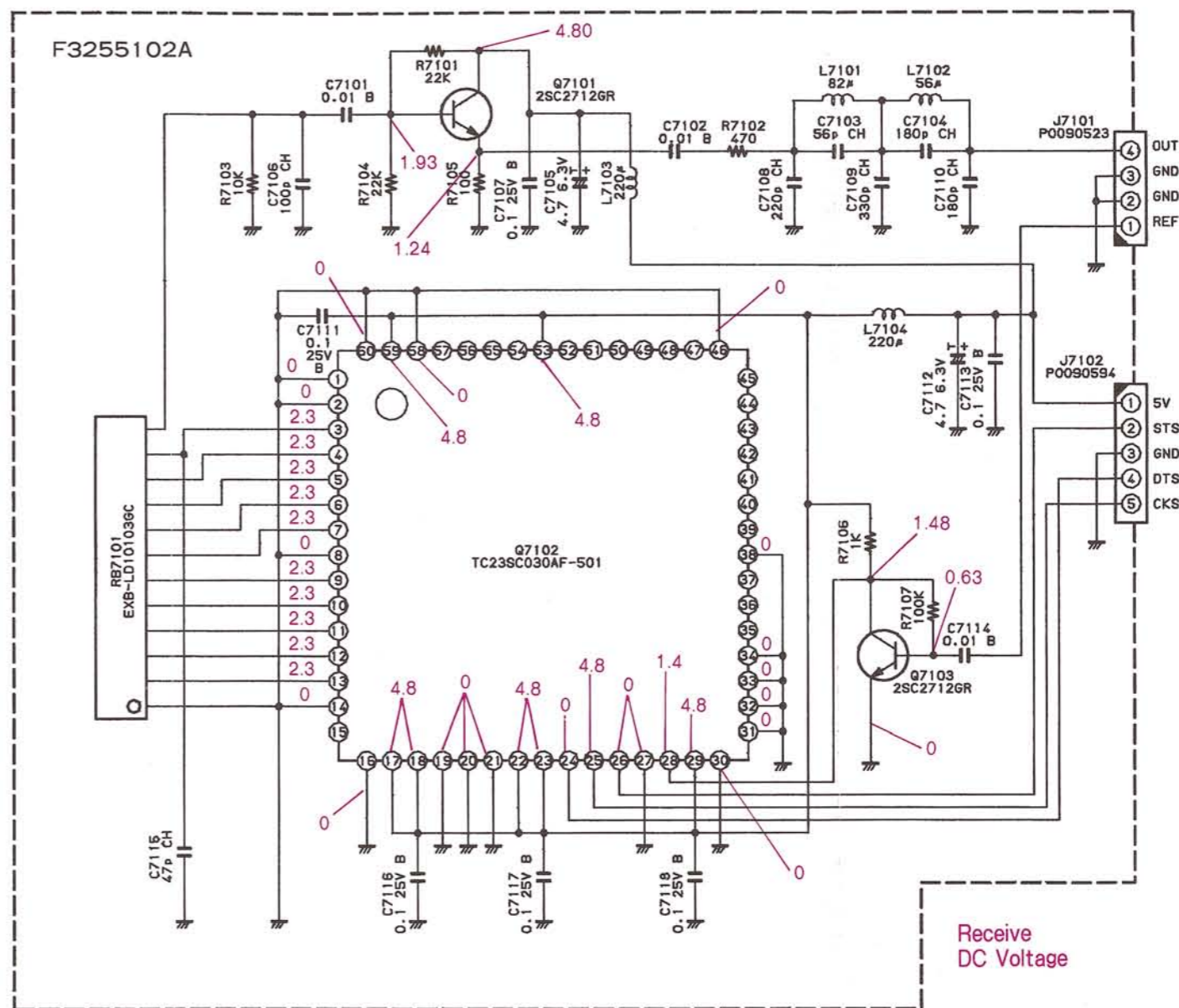

TC23SC030AF-501
(Q7102)

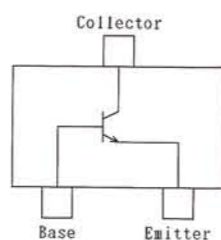

2SC2712GR (LG)
(Q7101, Q7103)

Sub DDS Unit

REF.	DESCRIPTION	VALUE	WV	TOL.	MFGR'S DESIG	YAESU P/N	VERS.	Addr
*** SUB-DDS UNIT ***								
	PCB W COMP.					CA0385001		
	PCB W/O COMP.					F3255102A		
C 7101	CHIP CAP.	0.01uF	50V	B	GRM40B103M50PT	K22170817		
C 7102	CHIP CAP.	0.01uF	50V	B	GRM40B103M50PT	K22170817		
C 7103	CHIP CAP.	56pF	50V	CH	GRM40CH560J50PT	K22170229		
C 7104	CHIP CAP.	180pF	50V	CH	GRM40CH181J50PT	K22170241		
C 7105	TANTALUM CHIP CAP.	4.7uF	6.3V		TEMSVA0J475M-8R	K78080017		
C 7106	CHIP CAP.	100pF	50V	CH	GRM40CH101J50PT	K22170235		
C 7107	CHIP CAP.	0.1uF	25V	B	GRM40B104M25PT	K22140811		
C 7108	CHIP CAP.	220pF	50V	CH	GRM40CH221J50PT	K22170243		
C 7109	CHIP CAP.	330pF	50V	CH	GRM40CH331J50PT	K22170247		
C 7110	CHIP CAP.	180pF	50V	CH	GRM40CH181J50PT	K22170241		
C 7111	CHIP CAP.	0.1uF	25V	B	GRM40B104M25PT	K22140811		
C 7112	TANTALUM CHIP CAP.	4.7uF	6.3V		TEMSVA0J475M-8R	K78080017		
C 7113	CHIP CAP.	0.1uF	25V	B	GRM40B104M25PT	K22140811		
C 7114	CHIP CAP.	0.01uF	50V	B	GRM40B103M50PT	K22170817		
C 7115	CHIP CAP.	47pF	50V	CH	GRM40CH470J50PT	K22170227		
C 7116	CHIP CAP.	0.1uF	25V	B	GRM40B104M25PT	K22140811		
C 7117	CHIP CAP.	0.1uF	25V	B	GRM40B104M25PT	K22140811		
C 7118	CHIP CAP.	0.1uF	25V	B	GRM40B104M25PT	K22140811		
J 7101	CONNECTOR				3022-04B	P0090523		
J 7102	CONNECTOR				3022-05B	P0090594		
L 7101	M. RFC	82uH			LAP02TA820K	L1790069		
L 7102	M. RFC	56uH			LAP02TA560K	L1790067		
L 7103	M. RFC	220uH			LAP02TA221K	L1790074		
L 7104	M. RFC	220uH			LAP02TA221K	L1790074		
Q 7101	TRANSISTOR				2SC2712GR TE85R	G3327127G		
Q 7102	IC				TC23SC030AF-501	G1090970		
Q 7103	TRANSISTOR				2SC2712GR TE85R	G3327127G		
R 7101	CHIP RES.	22K	1/10W		RMC1/10T 223J	J24205223		
R 7102	CHIP RES.	470	1/10W		RMC1/10T 471J	J24205471		
R 7103	CHIP RES.	10K	1/10W		RMC1/10T 103J	J24205103		
R 7104	CHIP RES.	22K	1/10W		RMC1/10T 223J	J24205223		
R 7105	CHIP RES.	100	1/10W		RMC1/10T 101J	J24205101		
R 7106	CHIP RES.	1K	1/10W		RMC1/10T 102J	J24205102		
R 7107	CHIP RES.	100K	1/10W		RMC1/10T 104J	J24205104		
RB7101	BLOCK RES.				EXB-LD10103GC	J40900171		

Notes

Notch Unit

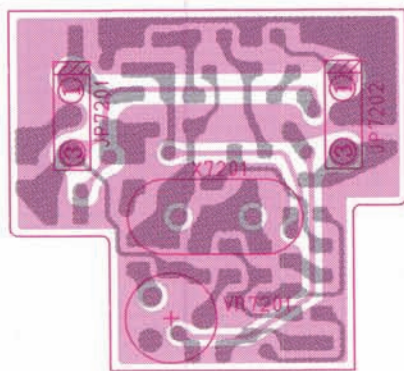
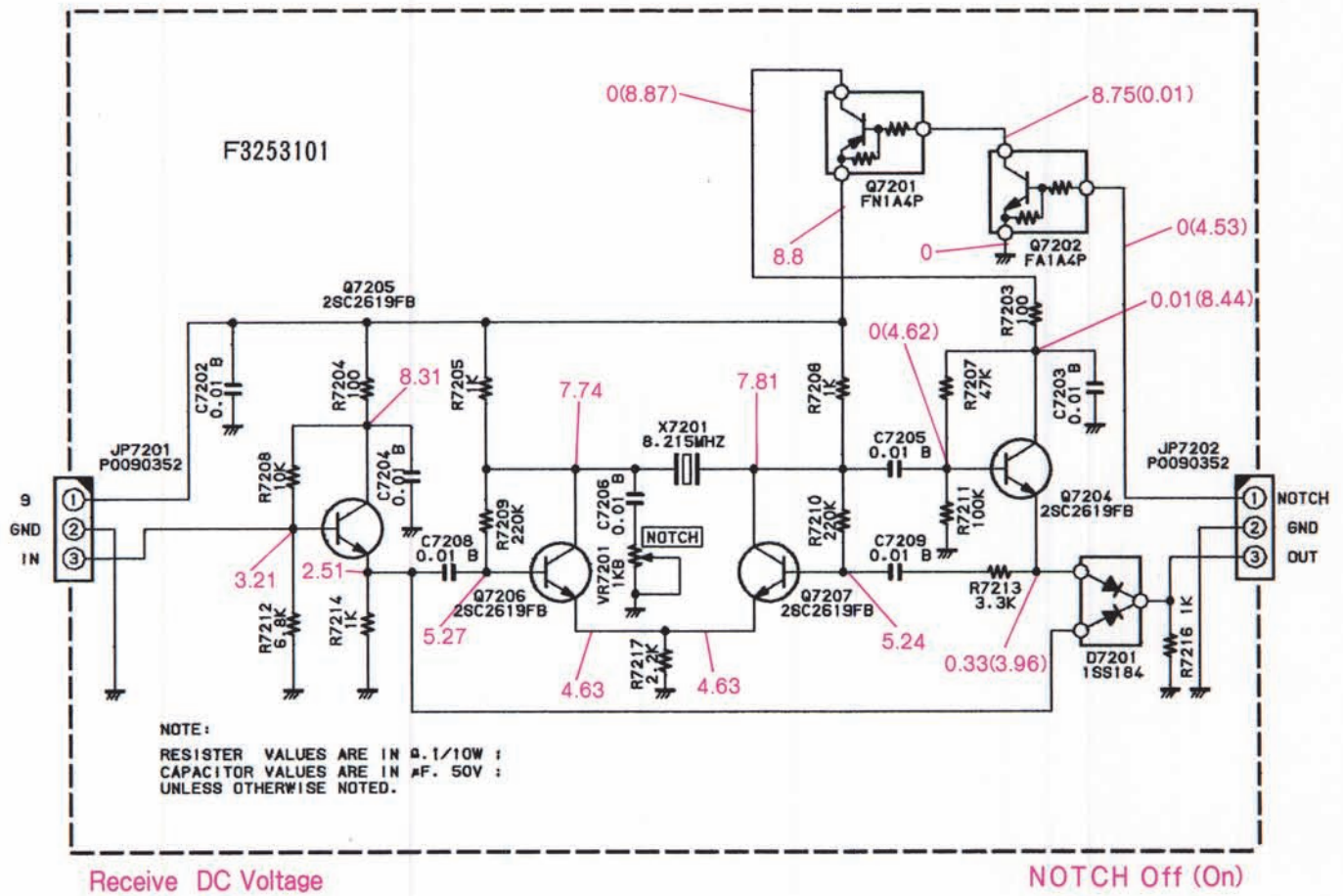

"component" side

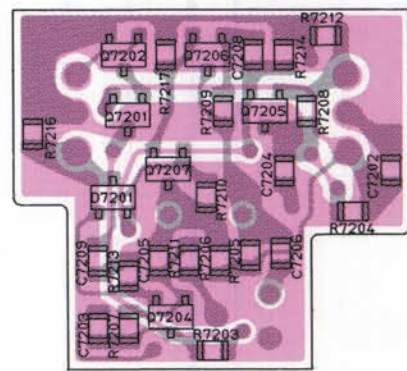

"chip-only" side

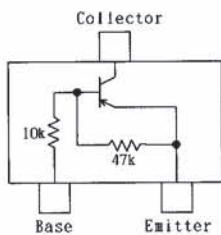

FN1A4P (M34)
(Q7201)

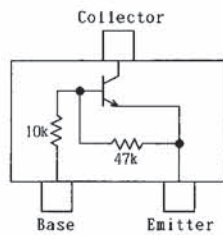

FA1A4P (L34)
(Q7202)

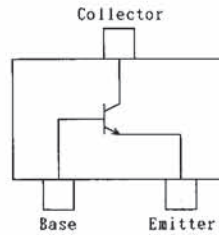

2SC2619 (FB)
(Q7204, Q7205, Q7206)
7207

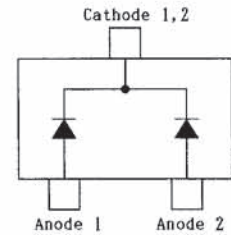

1SS184 (B3)
(D7201)

Notch Unit

REF.	DESCRIPTION	VALUE	WV	TOL.	MFGR'S DESIG	YAESU P/N	VERS.	Addr
*** NOTCH UNIT ***								
	PCB W COMP.					CA0445001		
	PCB W/O COMP.					F3253101		
C 7202	CHIP CAP.	0.01uF	50V	B	GRM40B103M50PT	K22170817		
C 7203	CHIP CAP.	0.01uF	50V	B	GRM40B103M50PT	K22170817		
C 7204	CHIP CAP.	0.01uF	50V	B	GRM40B103M50PT	K22170817		
C 7205	CHIP CAP.	0.01uF	50V	B	GRM40B103M50PT	K22170817		
C 7206	CHIP CAP.	0.01uF	50V	B	GRM40B103M50PT	K22170817		
C 7208	CHIP CAP.	0.01uF	50V	B	GRM40B103M50PT	K22170817		
C 7209	CHIP CAP.	0.01uF	50V	B	GRM40B103M50PT	K22170817		
D 7201	DIODE				1SS184 TE85R	G2070009		
JP7201	CONNECTOR				3022-03A	P0090352		
JP7202	CONNECTOR				3022-03A	P0090352		
Q 7201	TRANSISTOR				FN1A4P-T2B	G3070011		
Q 7202	TRANSISTOR				FA1A4P-T2B	G3070006		
Q 7204	TRANSISTOR				2SC2619FBTR	G3326197B		
Q 7205	TRANSISTOR				2SC2619FBTR	G3326197B		
Q 7206	TRANSISTOR				2SC2619FBTR	G3326197B		
Q 7207	TRANSISTOR				2SC2619FBTR	G3326197B		
R 7203	CHIP RES.	100	1/10W		RMC1/10T 101J	J24205101		
R 7204	CHIP RES.	100	1/10W		RMC1/10T 101J	J24205101		
R 7205	CHIP RES.	1K	1/10W		RMC1/10T 102J	J24205102		
R 7206	CHIP RES.	1K	1/10W		RMC1/10T 102J	J24205102		
R 7207	CHIP RES.	47K	1/10W		RMC1/10T 473J	J24205473		
R 7208	CHIP RES.	10K	1/10W		RMC1/10T 103J	J24205103		
R 7209	CHIP RES.	220K	1/10W		RMC1/10T 224J	J24205224		
R 7210	CHIP RES.	220K	1/10W		RMC1/10T 224J	J24205224		
R 7211	CHIP RES.	100K	1/10W		RMC1/10T 104J	J24205104		
R 7212	CHIP RES.	6.8K	1/10W		RMC1/10T 682J	J24205682		
R 7213	CHIP RES.	3.3K	1/10W		RMC1/10T 332J	J24205332		
R 7214	CHIP RES.	1K	1/10W		RMC1/10T 102J	J24205102		
R 7216	CHIP RES.	1K	1/10W		RMC1/10T 102J	J24205102		
R 7217	CHIP RES.	2.2K	1/10W		RMC1/10T 222J	J24205222		
VR7201	POT.	1KB			H0651A007-1KB	J51745102		
X 7201	XTAL	8.215MHZ				H0102968		

Notes

Potentiometer (VR) A,B Unit Clarifier (CLAR) Unit

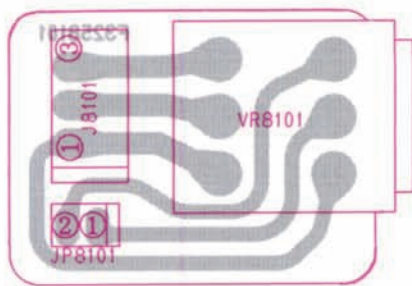

"component" side

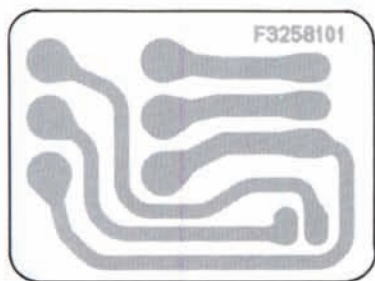

"solder" side

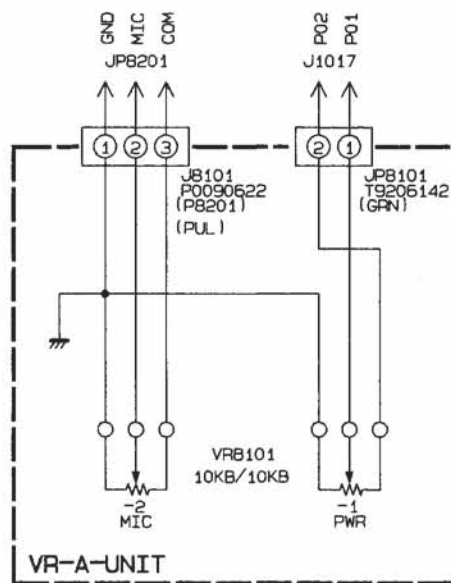

F3258101



"component" side

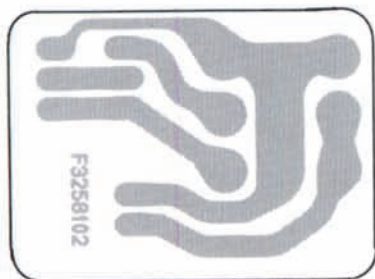

"solder" side

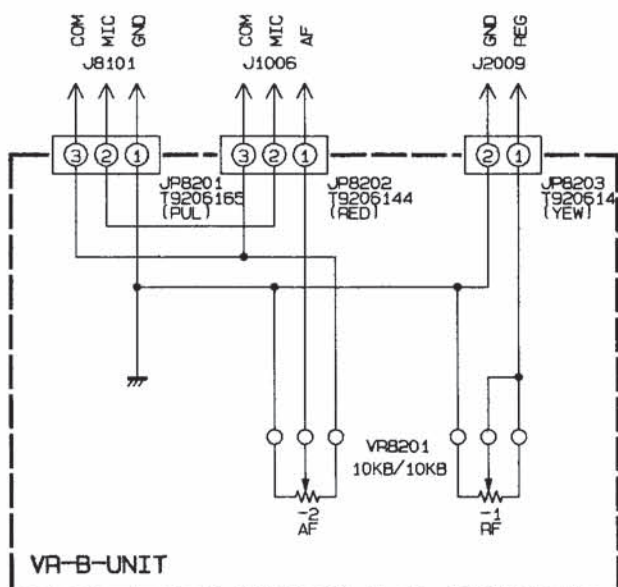

F3258102

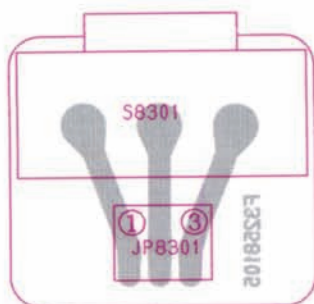

"component" side

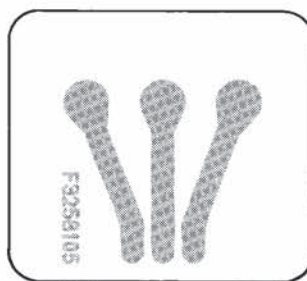

"solder" side

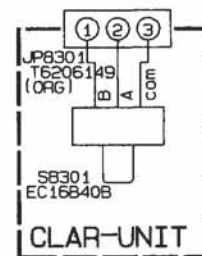

F3258105

Potentiometer (VR) A,B Unit
Clarifier (CLAR) Unit

REF.	DESCRIPTION	VALUE	WV	TOL.	MFGR'S DESIG	YAESU P/N	VERS.	Addr
*** VR-A UNIT ***								
	PCB W COMP.					CA0606001		
	PCB W/O COMP.					F3258101		
J 8101	CONNECTOR				SC25-03WS	P0090622		
JP8101	WIRE-ASSY					T9206142		
VR8101	POT.	10KB/10KB			RK1242210	J62800115		

REF.	DESCRIPTION	VALUE	WV	TOL.	MFGR'S DESIG	YAESU P/N	VERS.	Addr
*** VR-B UNIT ***								
	PCB W COMP.					CA0602001		
	PCB W/O COMP.					F3258102		
JP8201	WIRE-ASSY					T9206165		
JP8202	WIRE-ASSY					T9206144		
JP8203	WIRE-ASSY					T9206143		
VR8201	POT.	10KB/10KC			RK1242210	J62800114		

REF.	DESCRIPTION	VALUE	WV	TOL.	MFGR'S DESIG	YAESU P/N	VERS.	Addr
*** CLAR UNIT ***								
	PCB W COMP.					CA0605001		
	PCB W/O COMP.					F3258105		
JP8301	WIRE-ASSY					T9206149		
S 8301	ROTARY CODE S.W.				EC16B40B	Q9000525		

Notes

Headphone (HP) Unit
 Microphone (MIC) Unit
 Potentiometer (VR) C Unit

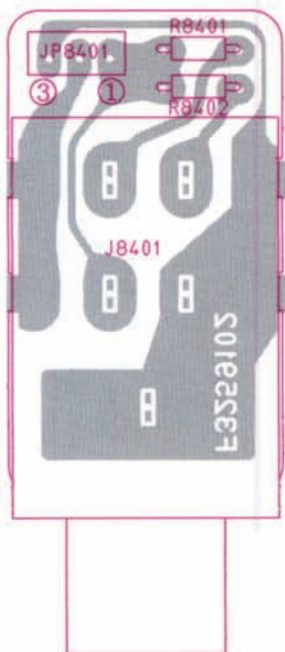

"component" side

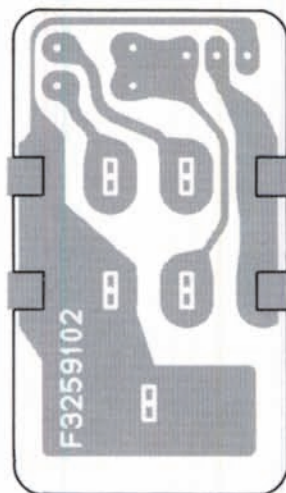

"solder" side

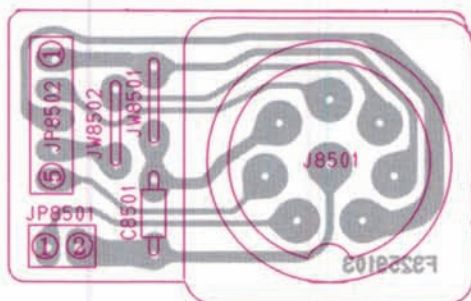
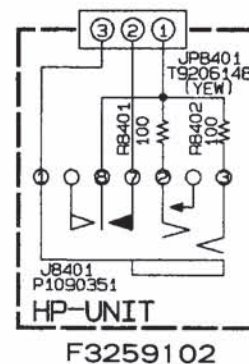

"component" side

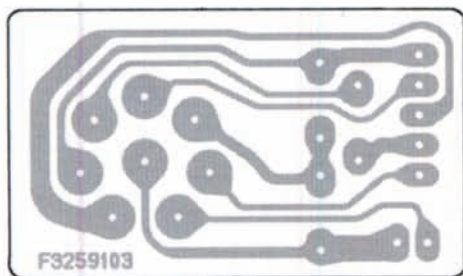
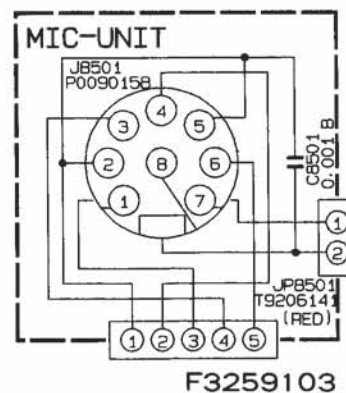

"solder" side

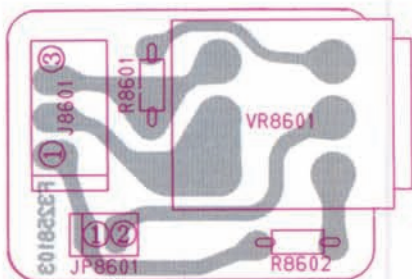
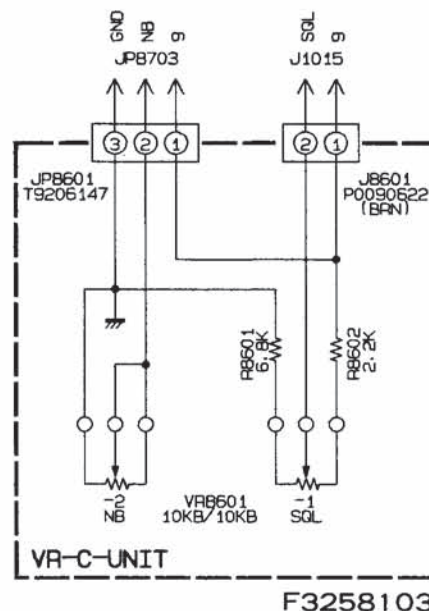

"component" side

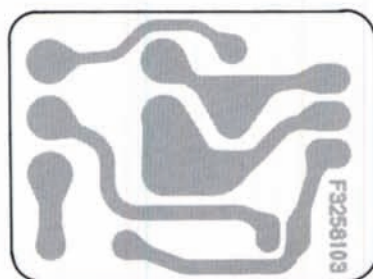

"solder" side

Headphone (HP) Unit
Microphone (MIC) Unit
Potentiometer (VR) C Unit

REF.	DESCRIPTION	VALUE	WV	TOL.	MFGR'S DESIG	YAESU P/N	VERS.	Addr
*** HP UNIT ***								
	PCB W COMP.					CA0607001		
	PCB W/O COMP.					F3259102		
J 8401	CONNECTOR				S-G4617#03	P1090351		
JP8401	WIRE-ASSY					T9206148		
R 8401	CARBON FILM RES.	100	1/6W		RD16TPJ101	J07225101		

REF.	DESCRIPTION	VALUE	WV	TOL.	MFGR'S DESIG	YAESU P/N	VERS.	Addr
*** MIC UNIT ***								
	PCB W COMP.					CA0604001		
	PCB W/O COMP.					F3259103		
C 8501	CERAMIC CAP.	0.001uF	50V	B	UP050B102K-A-B	K28179001		
J 8501	CONNECTOR				FM214-8SS(A)	P0090158		
JP8501	WIRE-ASSY					T9206141		

REF.	DESCRIPTION	VALUE	WV	TOL.	MFGR'S DESIG	YAESU P/N	VERS.	Addr
*** VR-C UNIT ***								
	PCB W COMP.					CA0734001		
	PCB W/O COMP.					F3258103		
J 8601	CONNECTOR				SC25-03WS	P0090622		
JP8601	WIRE-ASSY					T9206147		
R 8601	CARBON FILM RES.	6.8K	1/6W		RD16PJ682	J01225682		
R 8602	CARBON FILM RES.	2.2K	1/6W		RD16PJ222	J01225222		
VR8601	POT.	10KB/10KB			RK1242210	J62800115		

Notes

Potentiometer (VR) D Unit Keyer Control (CNTL) Unit

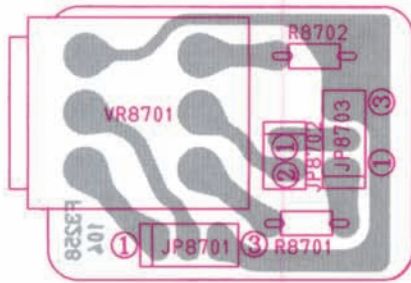

"component" side



"solder" side

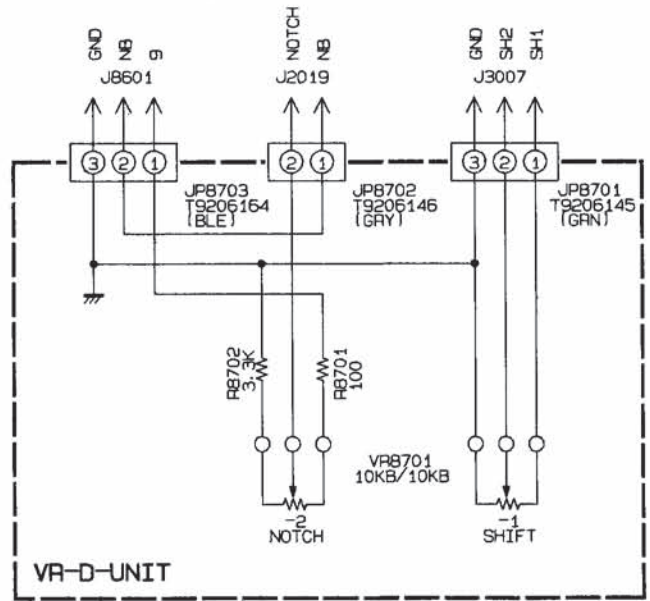

VR-D-UNIT

F3258104

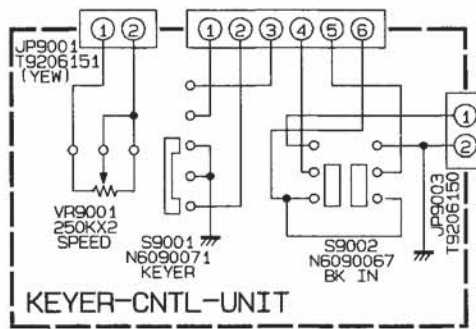

KEYER-CNTL-UNIT

F3254000A

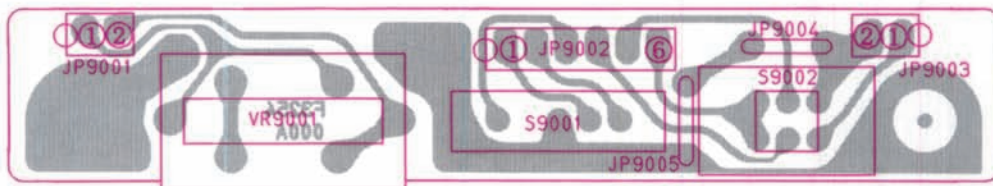

"component" side



"solder" side

Potentiometer (VR) D Unit
Keyer Control (CNTL) Unit

REF.	DESCRIPTION	VALUE	WV	TOL.	MFGR'S DESIG	YAESU P/N	VERS.	Addr
*** VR-D UNIT ***								
	PCB W COMP.					CA0735001		
	PCB W/O COMP.					F3258104		
JP8701	WIRE-ASSY					T9206145		
JP8702	WIRE-ASSY					T9206146		
JP8703	WIRE-ASSY					T9206164		
R 8701	CARBON FILM RES.	100	1/6W		RD16PJ101	J01225101		
R 8702	CARBON FILM RES.	3.3K	1/6W		RD16PJ332	J01225332		
VR8701	POT.	10KB/10KB			RK1242210	J62800115		

REF.	DESCRIPTION	VALUE	WV	TOL.	MFGR'S DESIG	YAESU P/N	VERS.	Addr
*** KEYER-CNTL UNIT ***								
	PCB W COMP.					CA0603001		
	PCB W/O COMP.					F3254000A		
JP9001	WIRE-ASSY					T9206151		
JP9003	WIRE-ASSY					T9206150		
S 9001	SLIDE SWITCH				SSSS91	N6090071		
S 9002	SLIDE SWITCH				SS922148	N6090067		
VR9001	POT.	250KX2			S1021G901	J64800002		

Switch (SW) A Unit

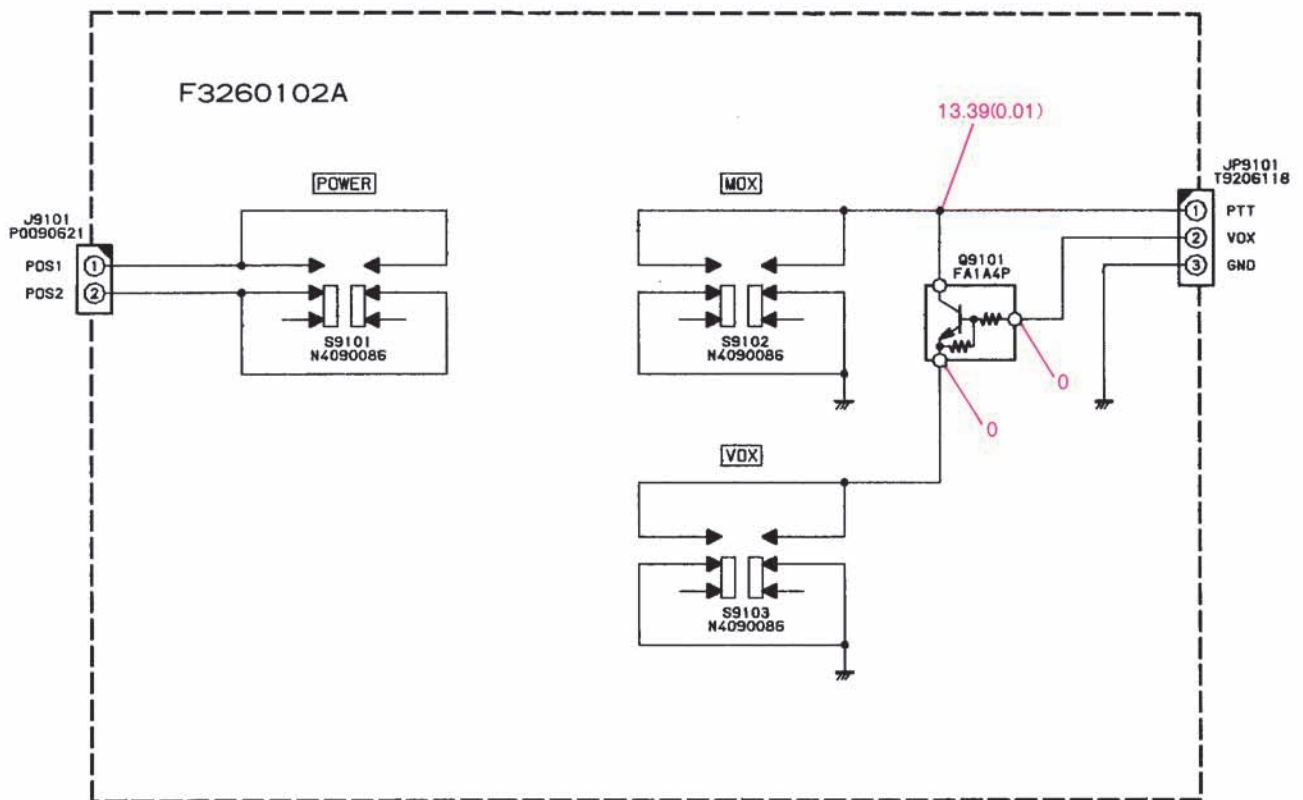

Receive (Transmit) DC Voltage

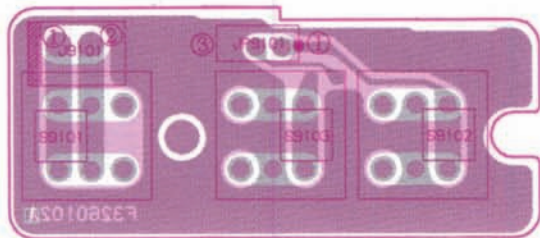

"component" side

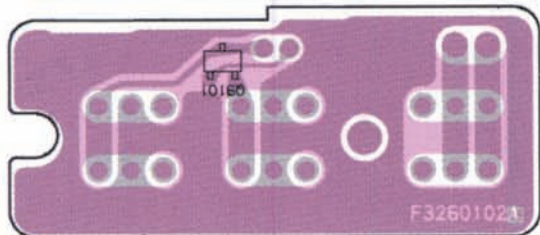

"chip-only" side

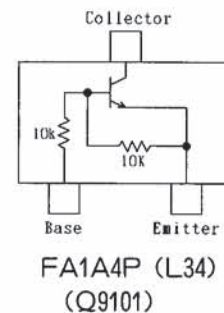

FA1A4P (L34)
(Q9101)

REF.	DESCRIPTION	VALUE	WV	TOL.	MFGR'S DESIG	YAESU P/N	VERS.	Addr
*** SW-A UNIT ***								
	PCB W COMP.					CA0736001		
	PCB W/O COMP.					F3260102A		
J 9101	CONNECTOR				SC25-02WS	P0090621		
JP9101	WIRE-ASSY					T9206118		
Q 9101	TRANSISTOR				FA1A4P-T2B	G3070006		
S 9101	PUSH SWITCH				SPH121A94	N4090086		
S 9102	PUSH SWITCH				SPH121A94	N4090086		
S 9103	PUSH SWITCH				SPH121A94	N4090086		

Switch (SW) B Unit

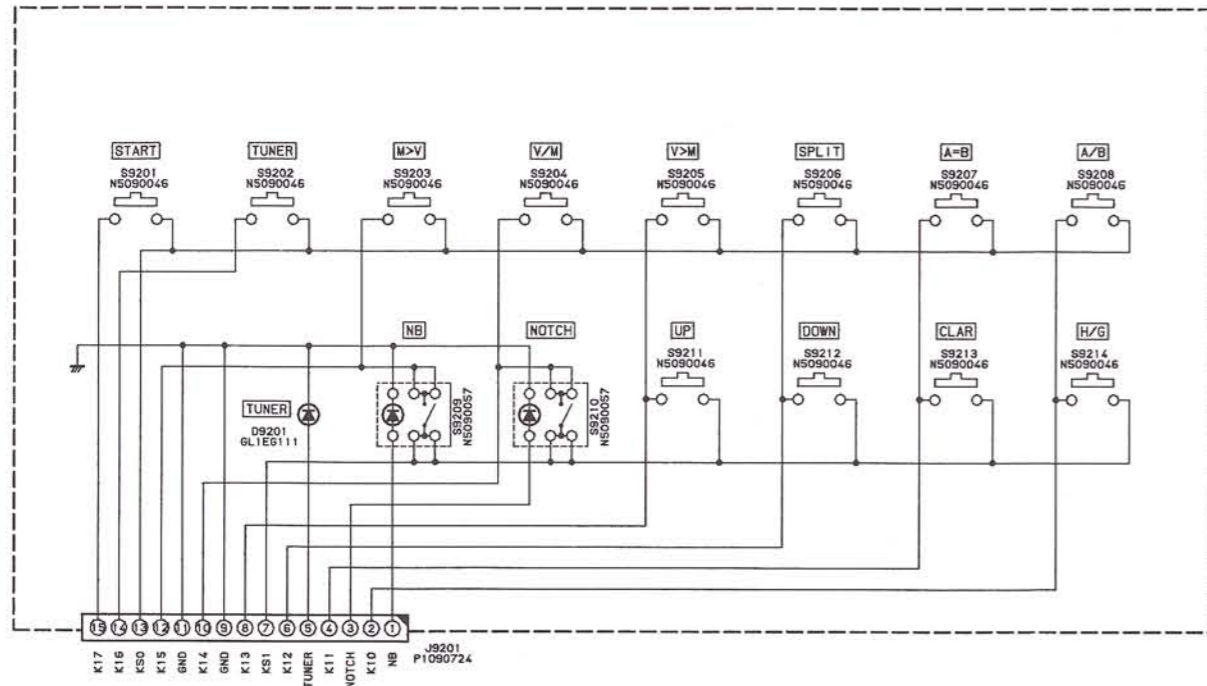

REF.	DESCRIPTION	VALUE	WV	TOL.	MFGR'S DESIG	YAESU P/N	VERS.	Addr
*** SW-B UNIT ***								
	PCB W COMP.					CA0737001		
	PCB W/O COMP.					F3259101		
D 9201	LED				GL1EG111	G2090474		
J 9201	CONNECTOR				52089-1510	P1090724		
S 9201	TACT SWITCH				EVQ-333 H=5.0 TAPE	N5090046		
S 9202	TACT SWITCH				EVQ-333 H=5.0 TAPE	N5090046		
S 9203	TACT SWITCH				EVQ-333 H=5.0 TAPE	N5090046		
S 9204	TACT SWITCH				EVQ-333 H=5.0 TAPE	N5090046		
S 9205	TACT SWITCH				EVQ-333 H=5.0 TAPE	N5090046		
S 9206	TACT SWITCH				EVQ-333 H=5.0 TAPE	N5090046		
S 9207	TACT SWITCH				EVQ-333 H=5.0 TAPE	N5090046		
S 9208	TACT SWITCH				EVQ-333 H=5.0 TAPE	N5090046		
S 9209	TACT SWITCH				SKHQFE	N5090057		
S 9210	TACT SWITCH				SKHQFE	N5090057		
S 9211	TACT SWITCH				EVQ-333 H=5.0 TAPE	N5090046		
S 9212	TACT SWITCH				EVQ-333 H=5.0 TAPE	N5090046		
S 9213	TACT SWITCH				EVQ-333 H=5.0 TAPE	N5090046		
S 9214	TACT SWITCH				EVQ-333 H=5.0 TAPE	N5090046		

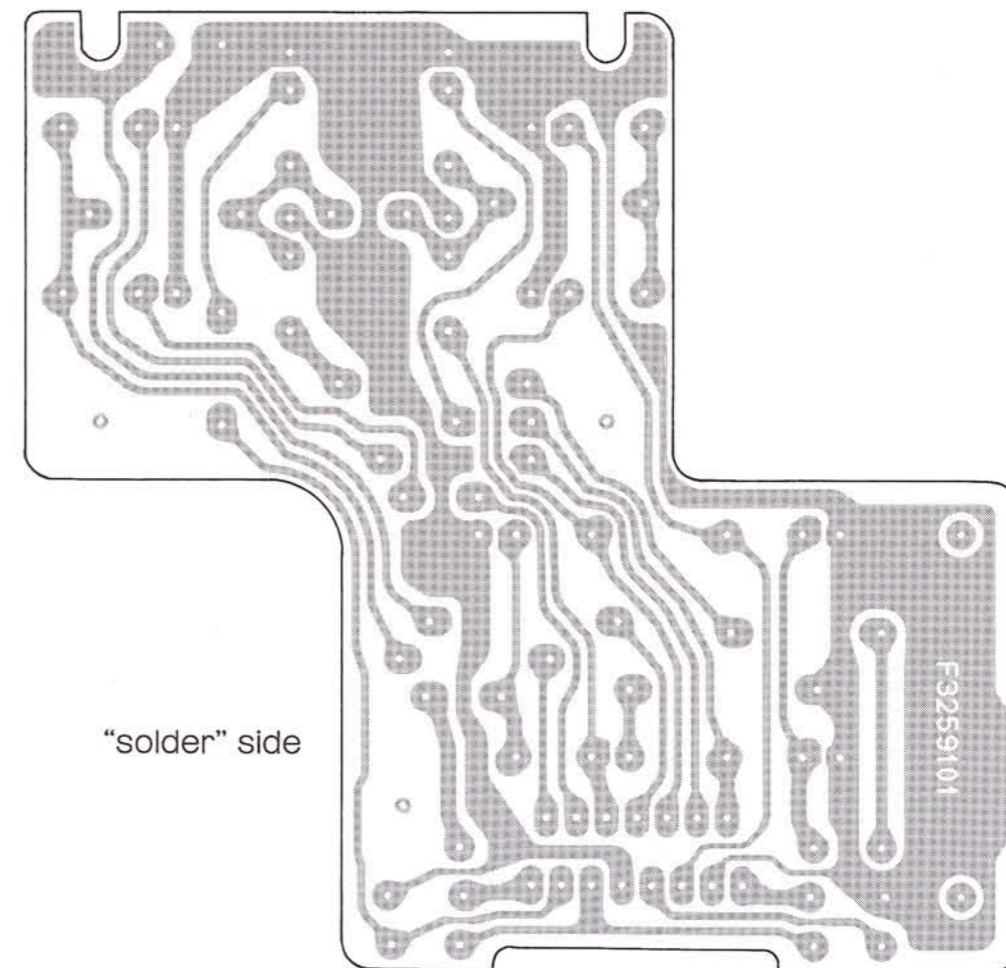
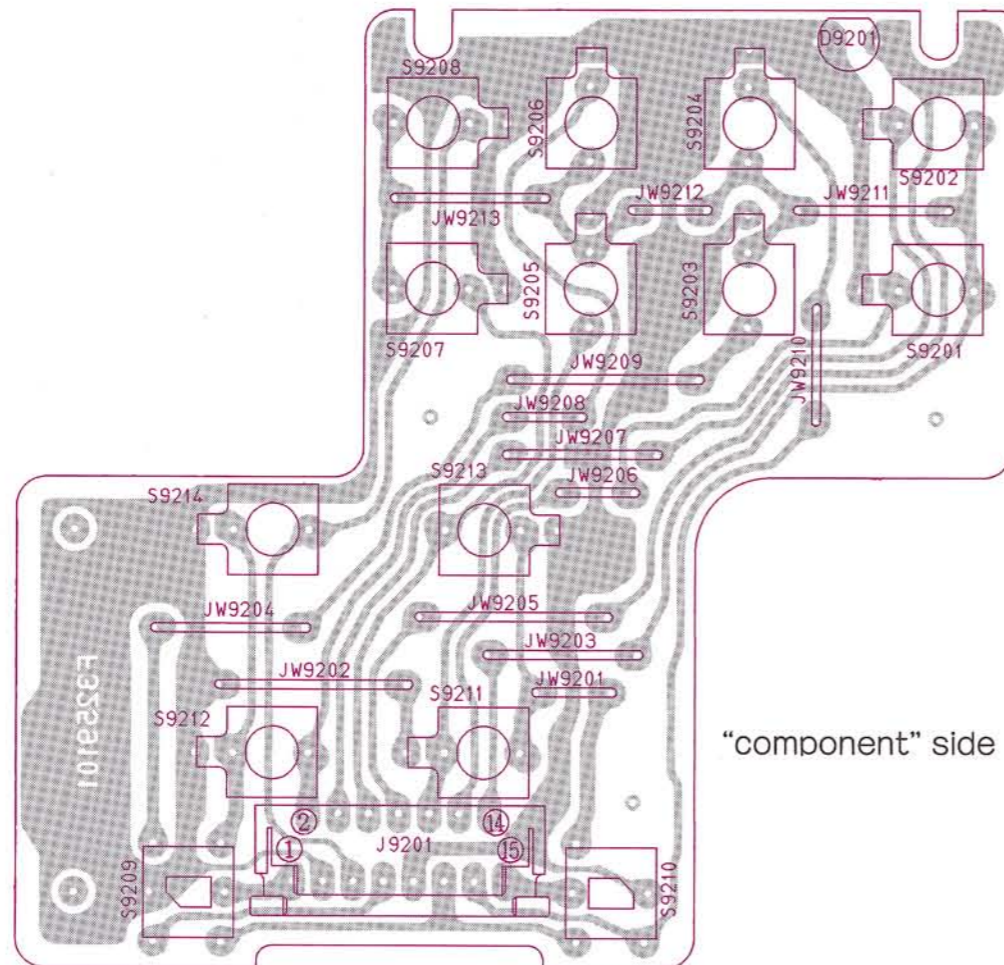

Switch (SW) C Unit

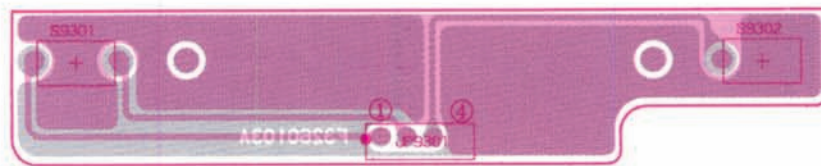
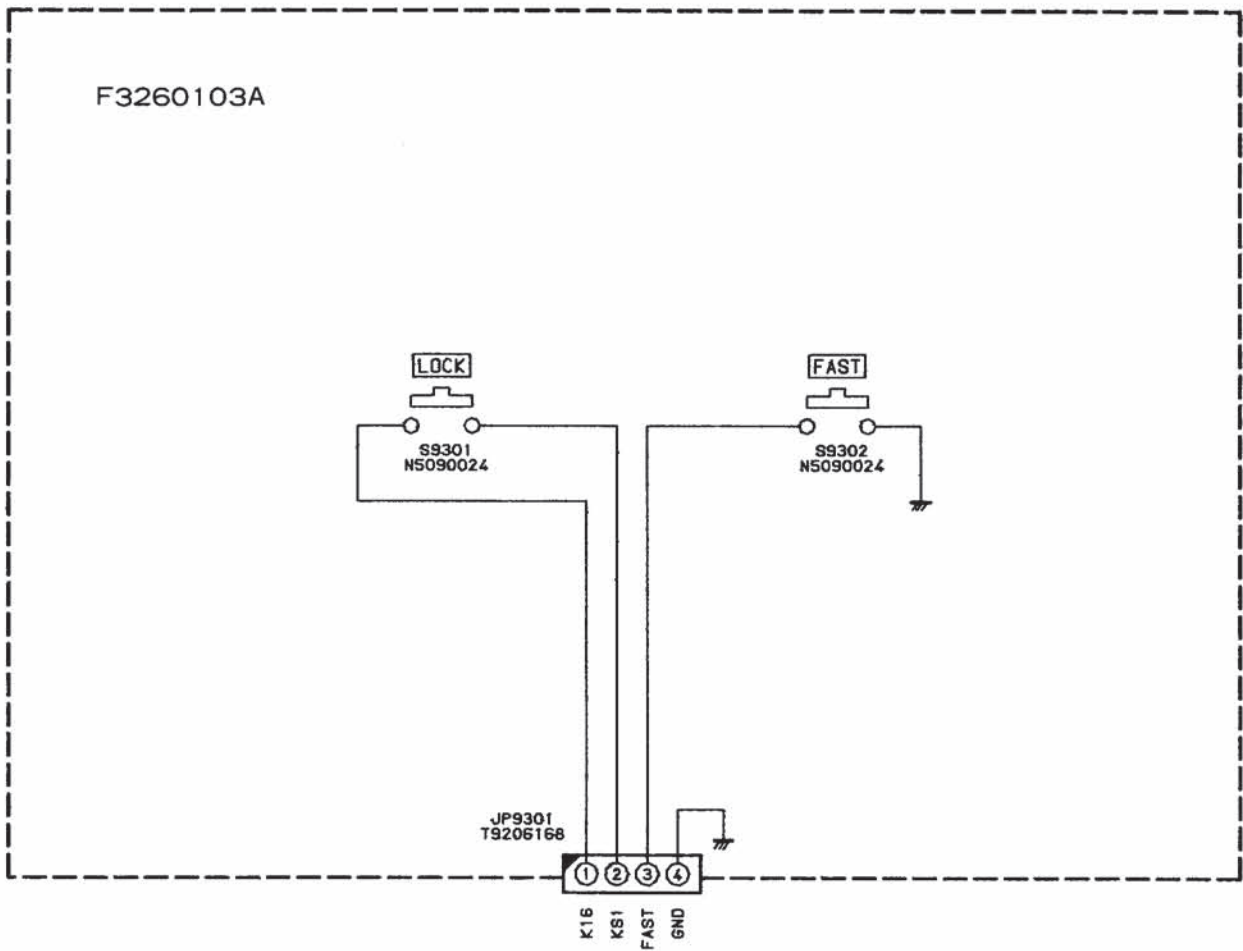

"component" side

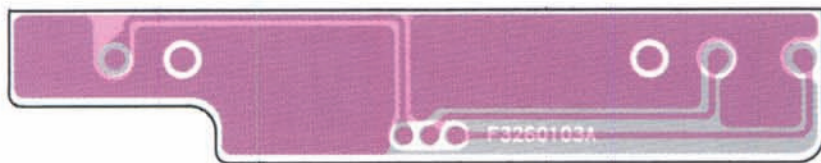

"solder" side

REF.	DESCRIPTION	VALUE	WV	TOL.	MFGR'S DESIG	YAESU P/N	VERS.	Addr
*** SW-C UNIT ***								
	PCB W COMP.					CA0808001		
	PCB W/O COMP.					F3260103A		
JP9301	WIRE-ASSY					T9206168		
S 9301	TACT SWITCH				SKHLAA	N5090024		
S 9302	TACT SWITCH				SKHLAA	N5090024		

REF.	YAESU P/N	Description	Qty.
1	U00306007	PAN HEAD M3×6B	1
2	U00405007	PAN HEAD M4×5B	4
3	U00310001	PAN HEAD M3×10	2
4	U02306001	SEMS SM3×6	2
5	U03306001	SEMS ASM3×6	8
6	U04206001	SEMS HSM2.6×6	2
7	U03308001	SEMS ASM3×8	1 (10W/25W) 5 (100W)
8	U20205001	BINDING HEAD M2.6×5	5
9	U20304001	BINDING HEAD M3×4	1
10	U20304007	BINDING HEAD M3×4B	4
11	U20306001	BINDING HEAD M3×6	34(10W) 36(25W/100W)
12	U20306002	BINDING HEAD M3×6NI	2
13	U20306007	BINDING HEAD M3×6B	15
14	U22306007	SEMS HM3×6B	2
15	U23105001	TAPTITE M2×5	11
16	U24305001	TAPTITE M3×5	19
17	U31306001	OVAL HEAD M3×6	6
18	U31410007	OVAL HEAD M4×10B	2
19	U46308201	TAPPING 3×8	4
20	U62012001	VOLUME NUT 12×14×2(P1)	1
21	U70012001	PLAIN WASHER FW12	2
22	U70002001	PLAIN WASHER FW2.6	1
23	S5000102	TAPTITE M2×4	4

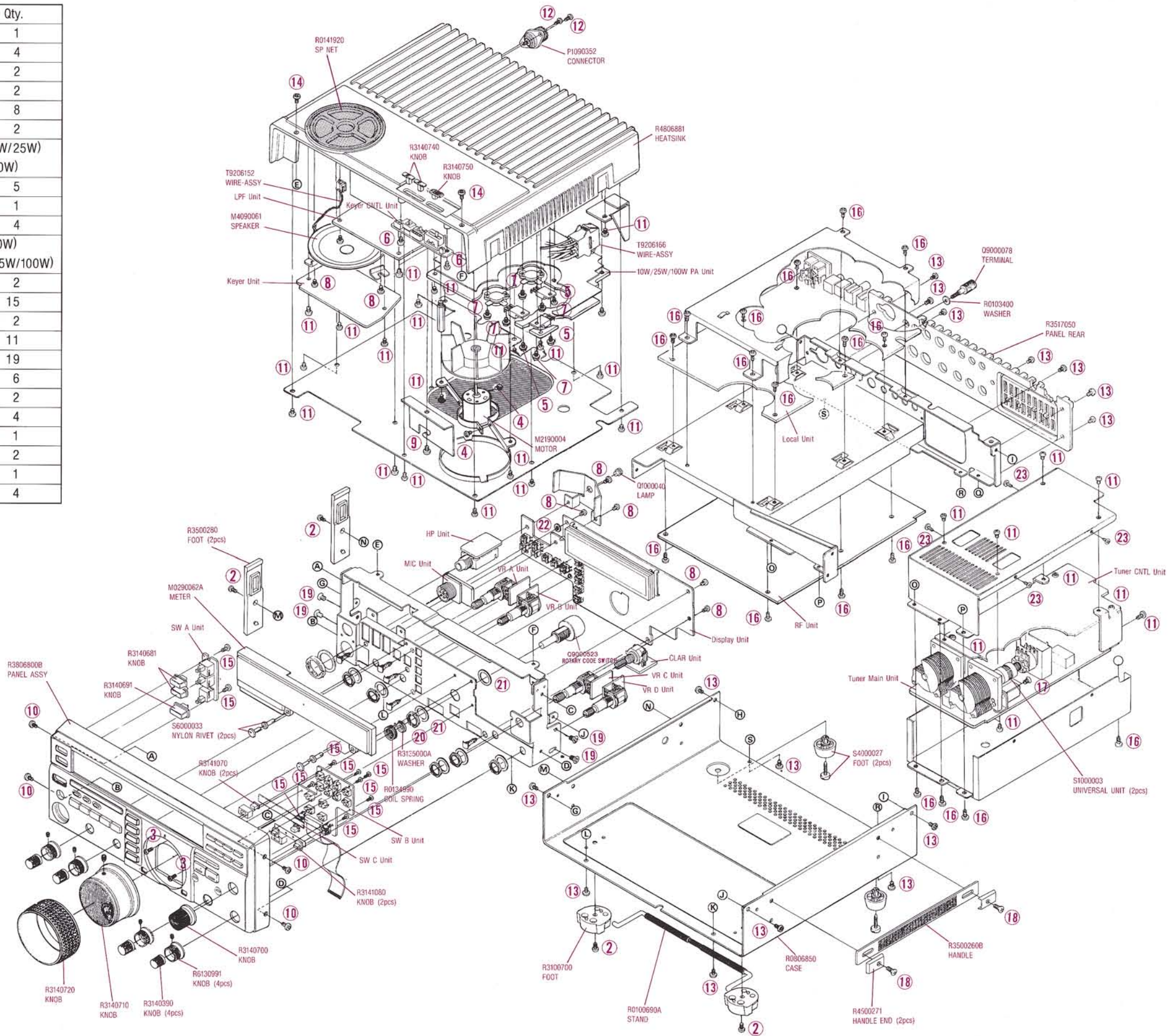

**Copyright © 1992
Yaesu Musen Co., Ltd.
All rights reserved.**

No portion of this manual
may be reproduced
without the permission of
Yaesu Musen Co., Ltd.